















GENERAL CATALOGUE 2018 - 2019

AUXILAB &
ROGO-SAMPAIC

YOUR BIG LOGISTIC PLATFORM
OF LABORATORY SUPPLIES
AND EQUIPMENT

material de uso general	
vasos, matraces y otros recipientes	
material volumétrico	
montajes e instrumental	
centrífugas	
equipos ópticos	
calor - frío	
instrumentos de medida	
agitación	
manipulación de líquidos	
separación - filtración	
material didáctico	
seguridad	
otros	



AUXILAB S.L.

Material de laboratorio
Laboratory supplies

Pol. Morea Norte Calle D Nave 6
C.P. 31191 Beriain -Navarra-

T. +34 948 310 513

correo@auxilab.es
www.auxilab.es



23 rue Ampère - ZI de Villemilan
91320 WISSOUS, FRANCE

T. +33(0)1 69 53 67 67
T. +33(0)1 69 30 72 55

rogosampalc@rogosampalc.com
www.rogosampalc.com

▶ THE GROUP

Since its foundation in 1976, Auxilab has been devoted to production and distribution of laboratory supplies. The quality given to its products, to investment in R+D, its highly qualified professionals and competitive prices have become this company a reference in the sector.

For more than 45 years Rogo-Sampaic has been a reference company for laboratory supplies distributors in France since it is a big logistic platform dedicated to import independent laboratory equipments and consumables.

In March 2011 Auxilab purchased the 100% of Rogo-Sampaic, which involved a noticeable development of both companies, by creating a stronger competence in distribution of laboratory equipments and consumables, thanks mainly to the following points:

- ▶ Increase of the catalogue product range up to 16.000 references.
- ▶ Increase of the capacity of stock (warehouse of 6.500 m²).
- ▶ Increase of the customer and supplier portfolio.
- ▶ Increase of the market share in Spanish and French markets.
- ▶ International coverage in more than 70 countries.
- ▶ Own trademarks such as Nahita, Nahita-Blue, Zuzi, Digipette, ENDO Glassware, ENDO Plasticware, ENDO Proteclab, Ura-Technic, RS Lab, RS-France and Ghaasel.
- ▶ Represented brands such as Kartell, Jipo, Simax, Glassco, Vitlab, Avignon Ceramic, Selecta, Socorex, RSG-Solingen, Saint-Gobain Performance Plastics, Agencinox, Gilac.
- ▶ Wide offer of products for sanitary, food, environmental, chemical and educational laboratories.
- ▶ Certified ISO 9001 by AENOR (since 1999).

▶ MISSION

▶ The main mission of Auxilab/Rogo-Sampaic is to provide distributors with the best price/quality relationship in all their range of products and with reduced delivery time.

- ▶ To achieve the maximum satisfaction of customers; thus, one of our main targets is to offer an excellent technical and after-sales service.
- ▶ To offer customers a wide range of quality products at very competitive prices.
- ▶ The distribution of our products is made exclusively through authorized suppliers, which guarantees more proximity, service and warranty.

▶ POSITIONING

Price and service are the base of Auxilab/Rogo-Sampaic philosophy.

Competitive advantages:

- ▶ Price: excellent price/quality relationship, to achieve the maximum profitability for our customers.
- ▶ Service: immediate delivery. Orders are delivered from our warehouse in 24/48 h.
- ▶ Stock: wide range of products in stock to assure a very low stockout rate.
- ▶ Logistics: high quality in service to customers, transport, inventory management, order processing.
- ▶ Technical assistance and after-sales service: qualified department that manage all our customers necessities.

▶ SERVICES

The main target of Auxilab/Rogo-Sampaic is to offer an excellent service to customers. Thus, we bet on offering our customers an added value in all their purchases.

- ▶ Advice: we offer a complete and personalized advice during the whole purchase process. We recommend the best options and the most interesting products depending on particular necessities of each customer.
- ▶ Technical after-sales service: our qualified department of technical and after-sales service guarantees a fast response and assistance. We act fast and effectively, giving preference to customer necessities.

▶ OUR TRADEMARKS

The group Auxilab/Rogo-Sampaic manufactures and markets its products under its own trademarks, so you can be sure that all items in this catalogue have passed the strictest quality controls, arriving to its destination in optimum conditions:

NAHITA: basic laboratory equipment and basic supplies

NAHITA-BLUE: basic laboratory equipment and basic supplies

RS LAB: stirrers and heating

ENDOGlassware: glassware

ENDOPlasticware: plasticware

ENDOProteclab: protection and safety products

DIGIPETTE: liquid handling

GHÄASEL: microscope slides

ZUZI: optical equipment

FILTRES RS: filter paper

RS FRANCE: microscope slides

URA TECHNIC: optical equipment



▶ REPRESENTED TRADEMARKS

We also distribute recognized standing trademarks. We offer a better service, increasing the range of products and giving the possibility of obtaining all kind of laboratory consumables.

The big effort made by Auxilab/ Rogo-Sampaic with the inclusion of these brands underlines our confidence in the sector and in the quality of the service we offer.

SOCOREX: Liquid handling of excellent accuracy

KARTELL: Plasticware manufactured with most advanced technology

JIPO: Technical porcelain of high quality

SIMAX: Glassware consumables with high resistance to sudden change in temperature

GLASSCO: Scientific glassware with ASTM Standards.

SAINT-GOBAIN PERFORMANCE PLASTICS: plastic, silicone and rubber products with very high quality, durability and resistance



UNIVET: protection glasses

PLUM: safety for your eyes

AVIGNON: porcelain of the best quality



INDEX
OF CONTENTS

	[01]		Page 5 - 34
GENERAL USE			
	[02]		Page 35 - 60
BEAKERS, FLASKS AND OTHER CONTAINERS			
	[03]		Page 61 - 70
VOLUMETRY			
	[04]		Page 71 - 96
LABORATORY ASSEMBLIES AND TOOLS			
	[05]		Page 97 - 108
CENTRIFUGES			
	[06]		Page 109 - 148
OPTICAL EQUIPMENTS			
	[07]		Page 149 - 156
HEATING/COOLING			
	[08]		Page 157 - 182
MEASURING INSTRUMENTS			
	[09]		Page 183 - 204
STIRRING			
	[10]		Page 205 - 212
LIQUID HANDLING			
	[11]		Page 213 - 252
FILTRATION AND SEPARATION			
	[12]		Page 253 - 288
DIDACTIC MATERIAL			
	[13]		Page 289 - 296
PROTECTION AND SAFETY			
	[14]		Page 297 - 314
OTHERS			

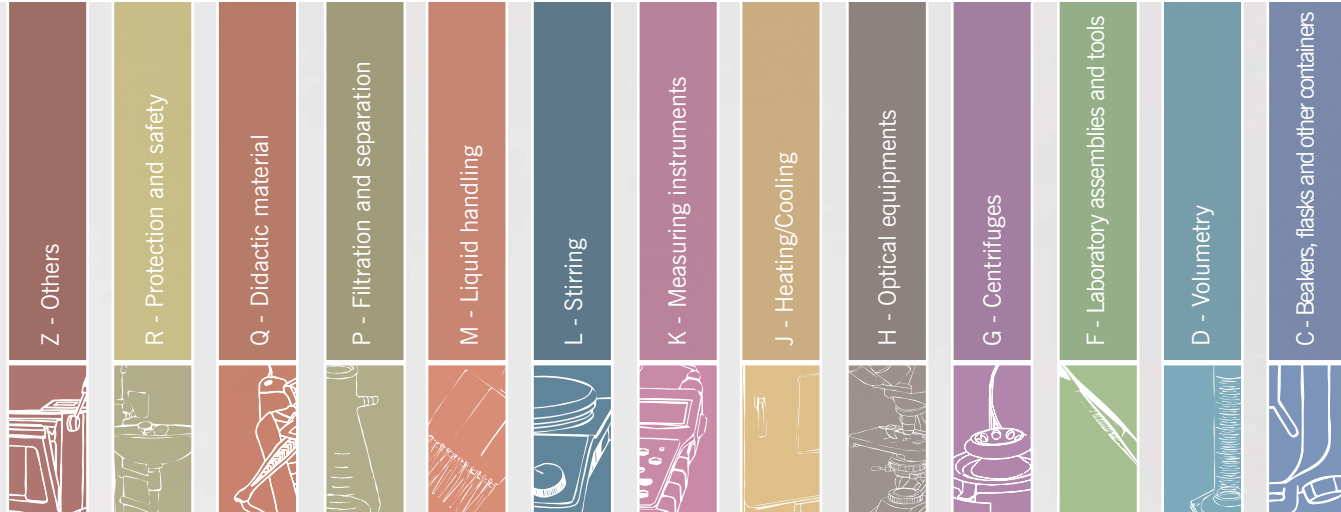

[B] INDEX OF CONTENTS GENERAL USE

[BB] Mortars.....06
 BBB - With pestle, glazed, porcelain06
 BBC - With pestle, not glazed, porcelain06
 BBD - With pestle, glass06
 BBF - With pestle, agate06
 BBN - Pestles, standard shape, porcelain07
 BBQ - Pestles, glass07
 BBR - Pestles, agate07
 BBT - Jars f/mills, agate07
 BBV - Balls08

[BD] Dessicators08
 BDB - With stopcock08
 BDD - Without stopcock09
 BDG - Disks09
 BDL - Accessories09

[BG] Tubes10
 BGB - Test tube10
 BGD - Centrifuge tubes11
 BGG - Culture tubes11
 BGJ - U tubes12
 BGL - Tube caps12
 BGN - Microtubes13
 BGV - Others13

[BJ] Racks and supports14
 BJB - For tubes, plastic14
 BJD - For tubes, metal16
 BJJ - For tubes, PVC17
 BJL - For microtubes18
 BJN - For pipettes19
 BJQ - For flasks19
 BJS - For funnels20

[BM] Stoppers20
 BMC - Glass20
 BMD - Conical shape, rubber21
 BMH - Perforated, rubber21
 BML - Borers21

[BP] Microscopy22
 BPB - Slides22
 BPD - Cover slides24
 BPG - Slide storage25
 BPJ - Embedding26
 BPL - Staining27

[BR] Microbiology29
 BRB - Petri dishes29
 BRG - Inoculating loops29
 BRJ - Counters30

[BT] Cuvettes and trays30
 BTB - Cuvettes, plastic30
 BTD - Cuvettes, glass31
 BTQ - Boxes, SS32
 BTS - Baskets, SS32

[BY] Others32
 BYF - Sample transport/Storage32

TRADEMARKS:



▶ BBB - With pestle, glazed, porcelain

Nahita



- 1| Ideal for grinding and mixing substances of low hardness.
- 2| Glazed outside and inside, wide and stable base.
- 3| With spout and pestle.

Code	Capacity	Ø	Pestle length
BBB001	150 mL	100 mm	150 mm
BBB002	300 mL	130 mm	330 mm
BBB003	500 mL	150 mm	500 mm
BBB004	1000 mL	210 mm	1000 mm

▶ BBC - With pestle, not glazed, porcelain

Nahita



- 1| Ideal for grinding and mixing substances of low hardness.
- 2| Non glazed outside and inside,
- 3| With spout and pestle.

Code	Capacity	Ø	Pestle length
BBC001	25 mL	60 mm	65 mm
BBC002	50 mL	80 mm	90 mm
BBC003	100 mL	100 mm	110 mm
BBC004	300 mL	130 mm	125 mm
BBC005	500 mL	160 mm	145 mm
BBC006	1000 mL	216 mm	215 mm
BBC007	2000 mL	254 mm	245 mm

▶ BBD - With pestle, glass

ENDO
glassware

- 1| Wide and stable base, polished inside and outside.
- 2| With spout.
- 3| Included glass pestle with one rough, ball-shaped end.

Code	Capacity	Ø	Pestle length
BBD001	90 mL	60 mm	90 mm
BBD002	100 mL	80 mm	105 mm
BBD003	200 mL	100 mm	60 mm
BBD004	400 mL	120 mm	130 mm
BBD005	900 mL	150 mm	180 mm

▶ BBF - With pestle, agate

Nahita

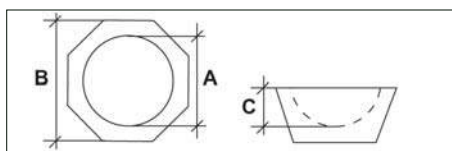

- 1| Supplied with pestle.
- 2| Polished inside and outside. The external surface is uniformly sanding.
- 3| Ideal for grinding and mixing substances of low hardness.

Code	Capacity	Dim. (BxAxC)	Pestle length
BBF001	5 mL	40x35x10 mm	52 mm
BBF002	15 mL	60x50x14 mm	59 mm
BBF003	30 mL	80x65x18 mm	63 mm
BBF004	70 mL	100x82x25 mm	81 mm
BBF005	140 mL	120x100x30 mm	101 mm
BBF006	150 mL	130x110x33 mm	107 mm
BBF007	150 mL	140x115x35 mm	110 mm
BBF008	200 mL	150x125x38 mm	116 mm
BBF009	275 mL	160x128x39 mm	120 mm
BBF010	375 mL	170x143x41 mm	135 mm
BBF011	500 mL	180x150x45 mm	150 mm
BBF012	750 mL	200x165x50 mm	155 mm

▶ BBN - Pestles, standard shape, porcelain

▶ Unglazed



1 | Glazed handle.

Code	For mortars	ø ball	ø handle	Lenght
BBN001	60 mm	19 mm	11 mm	65 mm
BBN002	80 mm	26 mm	15 mm	90 mm
BBN003	100 mm	27 mm	15 mm	110 mm
BBN004	130 mm	36 mm	18 mm	125 mm
BBN005	160 mm	40 mm	20 mm	145 mm
BBN006	216 mm	45 mm	27 mm	200 mm



▶ BBQ - Pestles, glass

▶ Glass



Code	For mortars	ø ball	Lenght
BBQ001	60 mm	20 mm	90 mm
BBQ002	80 mm	20 mm	105 mm
BBQ003	100 mm	25 mm	115 mm
BBQ004	120 mm	35 mm	130 mm
BBQ005	150 mm	38 mm	180 mm

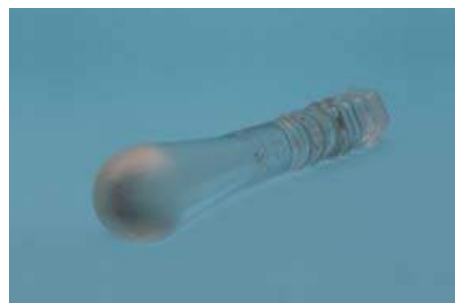

▶ BBR - Pestles, agate



Code	For mortar	Lenght
BBR001	60 mm	59 mm
BBR002	80 mm	63 mm
BBR003	100 mm	81 mm
BBR004	120 mm	101 mm



▶ BBT - Jars for mills, agate



▶ Agate jars without lid

- 1 | Without lid.
- 2 | Ideal for grinding and mixing substances of low hardness.

Code	Capacity	Dim. (Øx height)
BBT001	50 mL	65x50 mm
BBT002	100 mL	75x60 mm
BBT003	150 mL	90x70 mm
BBT004	250 mL	100x80 mm
BBT005	300 mL	105x85 mm
BBT006	400 mL	105x90 mm
BBT007	500 mL	115x95 mm



▶ BBT - Jars for mills, agate



▶ Lids for agate jars



Code	For mills of
BBT008	50 mL
BBT009	100 mL
BBT010	150 mL
BBT011	250 mL
BBT012	300 mL
BBT013	400 mL
BBT014	500 mL

▶ BBV - Balls



▶ Agate



Code	Diameter
BBV001	4 mm
BBV002	6 mm
BBV003	8 mm
BBV004	10 mm
BBV005	12 mm
BBV006	15 mm
BBV007	20 mm
BBV008	30 mm
BBV009	40 mm

▶ BDB - With stopcock

▶ Stopcock lid desiccator



- 1 | Lid with ground outlet and vacuum stopcock.
- 2 | With porcelain disk.

Code	Capacity	ø Inner	ø Outer	Height
BDB001	1 L	100 mm	136 mm	180 mm
BDB002	2 L	150 mm	210 mm	220 mm
BDB003	4 L	200 mm	270 mm	300 mm
BDB004	7 L	250 mm	305 mm	360 mm
BDB005	14 L	300 mm	365 mm	420 mm

▶ Vacuum desiccator



- 1 | Base and disc in polypropylene (PP), lid in polycarbonate (PC). Autoclavable.
- 2 | PTFE stopcock with 3 ways.
- 3 | Vacuum up to 740 mm Hg/24h
- 4 | Hose connection: 10 mm

Code	Diameter
BDB016	200 mm

BDD - Centrifuge tubes

▶ Knob lid desiccator



- 1| Without connection to vacuum pump.
- 2| Supplied with porcelain disk.

Code	Capacity	∅ Inner	∅ Outer	Height
BDD001	1 L	100 mm	136 mm	180 mm
BDD002	2 L	150 mm	210 mm	220 mm
BDD003	4 L	200 mm	270 mm	300 mm
BDD004	7 L	250 mm	305 mm	360 mm
BDD005	14 L	300 mm	365 mm	420 mm



▶ BDG - Disks

▶ Porcelain disks



- 1| Glazed on one side.

Code	Diameter	∅ holes
BDG001	90 mm	10 mm
BDG002	140 mm	10 mm
BDG003	190 mm	10 mm
BDG004	220 mm	10 mm
BDG005	275 mm	10 mm



▶ BDL - Accessories

▶ Knob lid for desiccator



Code	For desiccator	∅ outer	∅ inner
BDL001	100 mm	136 mm	100 mm
BDL002	150 mm	210 mm	155 mm
BDL003	200 mm	270 mm	210 mm
BDL004	250 mm	305 mm	250 mm
BDL005	300 mm	365 mm	305 mm



▶ Stopcock for desiccator



- 1| With male ground joint.

Code	Ground joint
BDL011	24/29
BDL012	19/28



BDL - Accessories

▶ Lid ground joint for desiccator



1 | Witj female ground joint. Lid is not included.

Code	For dessicator	Ground joint
BDL014	50 mm	19/28
BDL013	100 mm	19/28
BDL015	200 mm	24/29
BDL016	250 mm	24/29
BDL017	300 mm	24/29

▶ BGB - Test tubes

▶ Soda glass



1 | Rimless and with round bottom. Supplied in boxes of 250 units.

Code	ØxL	Cap.	Wall thickness
BGB001	10x75 mm	3 mL	0.5 mm
BGB002	12x75 mm	5 mL	0.5 mm
BGB003	12x100 mm	7 mL	0.8 mm

▶ Borosilicate glass



1 | Made of borosilicate glass 7.1. Rimless and round bottom

Code	ØxL	Cap.	Wall thickness
BGB005	10x100 mm	5 mL	0.8 mm
BGB006	16x160 mm	25 mL	1.0 mm
BGB007	16x100 mm	15 mL	0.8 mm
BGB008	18x180 mm	35 mL	1.5 mm
BGB009	20x200 mm.	50 mL	1.5 mm
BGB010	22x220 mm	65 mL	1.5 mm
BGB011	25x200 mm	80 mL	1.5 mm

▶ Test tube, PP



Code	Capacity	ØxL
BGB025	5 mL	12x75 mm
BGB026	15 mL	16x100 mm

▶ Test tube, PS



Code	Capacity	ØxL
BGB027	5 mL	12x75 mm
BGB028	15 mL	16x100 mm



BGD - Centrifuge tubes

Glass



- 1| Non graduated, with rim.
- 2| Capacity of 12 mL.

Code	Bottom	ØxL	Wall thickness
BGD001	Round	16x100 mm	1.2 mm
BGD002	Conical	16x110 mm	1.0 mm

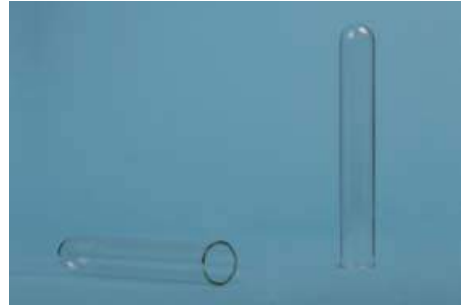

Glass ASTM



Code	Capacity	Shape
BGD003	100 mL	Cylindrical
BGD004	100 mL	Pear



Glass



Code	Capacity	Diameter	Height
BGD005	5 mL	13 mm	100 mm
BGD006	10 mL	15 mm	110 mm
BGD007	15 mL	17 mm	120 mm
BGD008	25 mL	22 mm	152 mm
BGD009	50 mL	30 mm	125 mm



Polypropylene



- 1| With threaded cap, conical bottom and graduation.
- 2| With marking area.

Code	Capacity	Dimensions	Batch
BGD010	15 mL	120x16 mm	50
BGD011	50 mL	117x29 mm	25
BGD070*	50 ml	115x30 mm	25

*self-standing bottom



BGG - Culture tubes

Durham Bell jar



Code	ØxH	Wall thickness	Pack
BGG011	7x50 mm	0,5 mm	C/1000

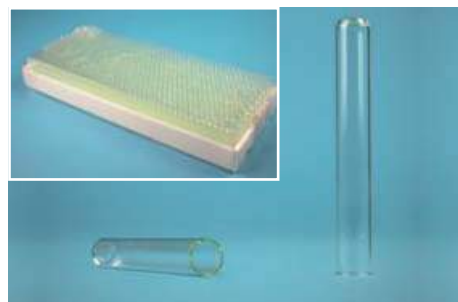

▶ BGG - Culture tubes

▶ Round bottom, PP stopper



1 | Borosilicate glass, stopper with PTFE joint.

Code	Capacity	ØxL
BGG001	5 mL	15x75 mm
BGG002	10 mL	15x125 mm
BGG003	15 mL	15x150 mm
BGG006	22 mL	16x160 mm
BGG005	25 mL	18x150 mm
BGG004	45 mL	25x150 mm

▶ Flat bottom, PP stopper



1 | Borosilicate glass, stopper with PTFE joint.

Code	Capacity	ØxL
BGG007	5 mL	18x45 mm
BGG009	30 mL	25x95 mm
BGG010	40 mL	25x145 mm

▶ BGJ - 'U' tubes



1 | Borosilicate glass, with beaded rims.

Code	Length	Diameter
BGJ001	150 mm	16 mm

▶ BGL - Tube caps

▶ PE, for tubes



Code	For tubes of	Colour	Lot
BGL022	12 mm	Red	1000
BGL023	16 mm	Green	1000

BGN - Microtubes

▶ Criotubes PP



- 1| Autoclavable and non-sterile.
- 2| Suitable for freezers, ultrafreezers or liquid nitrogen (vapour phase only).
External thread and marking area

Code	Capacity	Diameter	Height	Graduación	Pack
BGN001	2 mL	10 mm	45 mm	0,5 mL	B/500
BGN002	5 mL	15 mm	57 mm	1,0 mL	B/200

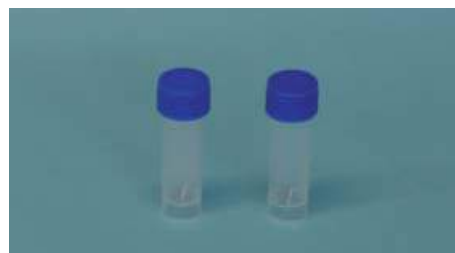

▶ PCR microtubes, PP



- 1| Conical bottom, with flat lid.
- 2| Sterilizable in autoclave and can be also frozen at -20 °C.
- 3| Supplied in bag of 1000 units.

Code	Capacity
BGN003	0,2 mL



▶ Centrifuge microtubes, PP



- 1| Graduated, Conical bottom and lid.

Code	Capacity	Units bag
BGN004	0.5 mL	1000
BGN005	1.5 mL	500
BGN025	2 mL	500



▶ Microtube strips for PCR, PP



- 1| Conical bottom, lid strip included.
- 2| Sterilizable in autoclave and can be also frozen at -20 °C.
- 3| Bags of 200 units.

Code	Description	Capacity
BGN006	Strip of 8 microtubes	0.2 mL
BGN007	Strips of 12 microtubes	0.2 mL



BGV - Others

▶ Kg of borosilicate glass tube



- 1| Made of borosilicate glass.

Code	Dimensions
BGV001	7x500 mm

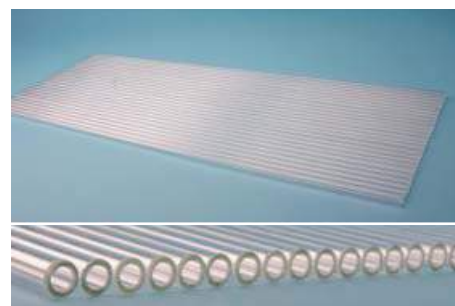

▶ BGV - Others

▶ Thiele tube



1 | Made of borosilicate glass.

Code	Diameter	Lenght	Volume
BGV002	24 mm	150 mm	40 mL

▶ Nessler tube



1 | Flat bottom, with spout.

Code	Diameter	Lenght	Engraved
BGV003	27 mm	210 mm	50/100 mL

▶ Glass tubing cutter



Code	For tubes until
BGV010	30 mm

▶ BJB - For tubes, plastic

▶ Multi support racks



1 | Sterilizable in autoclave.

Code	Capacity	Ø tubes	Colour
BJB021	40 tubes	17-20 mm	Red
BJB022	50 tubes	14-17 mm	White
BJB023	80 tubes	10-13 mm	White

▶ BJB - For tubes, plastic

▶ PP test tube rack



1 | Autoclavable and stackable, holes are labeled with alphanumeric marks.



Code	Alignment	N° holes	Ø	Colour
BJB001	6x15	90	13 mm	White
BJB002	6x15	90	13 mm	Blue
BJB003	6x15	90	13 mm	Red
BJB004	6x15	90	13 mm	Amarillo
BJB005	5x12	60	16 mm	White
BJB006	5x12	60	16 mm	Blue
BJB007	5x12	60	16 mm	Red
BJB008	5x12	60	16 mm	Amarillo
BJB009	4x10	40	20 mm	White
BJB010	4x10	40	20 mm	Blue
BJB011	4x10	40	20 mm	Red
BJB012	4x10	40	20 mm	Amarillo
BJB013	3x8	24	25 mm	White
BJB014	3x8	24	25 mm	Blue
BJB015	3x8	24	25 mm	Red
BJB016	3x8	24	25 mm	Amarillo
BJB017	3x7	21	30 mm	White
BJB018	3x7	21	30 mm	Blue
BJB019	3x7	21	30 mm	Red
BJB020	3x7	21	30 mm	Amarillo

▶ Multiposition rack



- 1 | Polypropylene autoclavable.
- 2 | With lateral hooks to joint several racks.
- 3 | Prepared to hold tubes of different sizes depending on position.

Code	Capacity	Ø tubes	Alignment
BJB026	32 tubes	11 mm	4x8
	12 tubes	16 mm	2x6
	4 tubes	29 mm	1x4

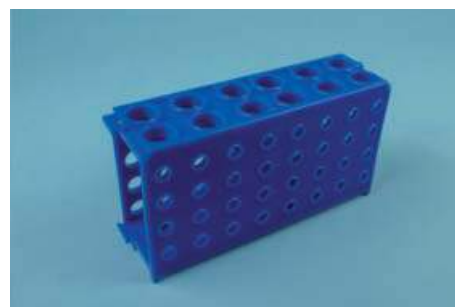

▶ Test tube rack Plexiglas



Code	Alignment	N° tubes	Dimensions (LxAxH)	Ø tube
BJB027	2x6	12	105x55x50 mm	14 mm
BJB028	2x12	24	205x55x50 mm	14 mm
BJB029	4x12	48	220x90x50 mm	14 mm
BJB030	2x3	6	140x95x100 mm	22 mm
BJB031	2x6	12	175x95x100	22 mm
BJB032	2x3	6	140x95x75 mm	32 mm
BJB033	2x6	12	225x95x75 mm	32 mm
BJB034	2x12	24	-	32 mm



▶ PP



1 | Disassembled, sterilizable in autoclave.

Code	N° tubes	Dimensions (LxAxH)	Ø tube
BJB035	31	27x6,5x12 cm	13 mm





BJD - For tubes, metal

▶ Stainless steel rack



1 | Autoclavables and very resistant, their special design makes them ideal for conical bottom tubes.

Code	Capacity	Diameter	Alignment
BJD004	12 tubes	13 mm	3x4
BJD005	24 tubes	13 mm	3x8
BJD006	50 tubes	13 mm	5x10
BJD007	100 tubes	13 mm	10x10
BJD008	12 tubes	16 mm	2x6
BJD009	24 tubes	16 mm	3x8
BJD010	50 tubes	16 mm	5x10
BJD011	72 tubes	16 mm	6x12
BJD012	100 tubes	16 mm	10x10
BJD013	24 tubes	18 mm	3x8
BJD014	50 tubes	18 mm	5x10
BJD015	72 tubes	18 mm	6x12
BJD016	100 tubes	18 mm	10x10
BJD017	12 tubes	25 mm	2x6
BJD018	24 tubes	25 mm	3x8
BJD019	50 tubes	25 mm	5x10
BJD020	72 tubes	25 mm	6x12

▶ Test tube rack Z-shaped



1 | Made of anodized aluminium, great durability and resistant to chemical and corrosive agents.

Code	Cap.	Diameter	Dim. (LxAxH)
BJD001	50	12 mm	170x995x55 mm
BJD002	50	14,5 mm	200x110x55 mm
BJD003	50	17,0 mm	225x120x68 mm

▶ AISI 304 stainless steel racks for test tubes

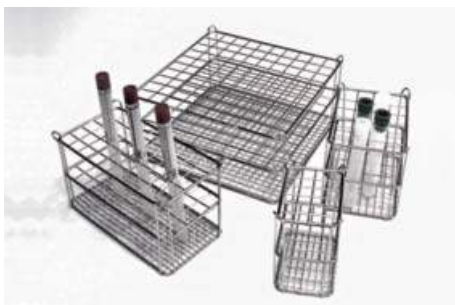

- 1 | Made of stainless steel AISI 304.
- 2 | Specially recommended for hospitals, laboratories, etc.
- 3 | These racks are stackable and have double weldings that provide high resistance and durability.

Code	Capacity	Tube Ø	Alignment	Dimensions
BJD021	24 tubes	10 mm	6x4	86x64x90 mm
BJD022	24 tubes	10 mm	6x4	86x64x60 mm
BJD023	50 tubes	12 mm	10x5	170x86x90 mm
BJD024	50 tubes	12 mm	10x5	170x86x60 mm
BJD025	24 tubes	14 mm	6x4	110x79x90 mm
BJD026	24 tubes	16 mm	6x4	125x90x90 mm
BJD027	50 tubes	16 mm	10x5	200x105x90 mm
BJD028	24 tubes	18 mm	6x4	135x93x90 mm
BJD029	50 tubes	18 mm	10x5	220x116x90 mm
BJD030	24 tubes	20 mm	6x4	145x105x90 mm
BJD031	50 tubes	20 mm	10x5	238x125x90 mm
BJD032	24 tubes	22 mm	6x4	161x113x90 mm
BJD033	24 tubes	30 mm	6x4	209x143x90 mm

▶ BJD - For tubes, metal

▶ Racks for Falcon tubes

- 1| Made of AISI 304 stainless steel with double wires that provide a higher resistance and durability.
- 2| For Falcon centrifuge tubes.

Code	Capacity	Tube	Alignment
BJD034	24 tubes	Falcon 15 ml	6x4
BJD035	24 tubes	Falcon 50 ml	6x4



▶ Racks for chromatography vials

- 1| Made of AISI 304 stainless steel, for chromatography vials 12x32mm.

Code	Capacity	Tubes	Alignment	Dimensions
BJD036	50 vials	12x32 mm	10x5	170x86x25 mm
BJD037	24 vials	12x32 mm	6x4	99x75x25 mm



▶ BJJ - For tubes, PVC



▶ For tubes of 13 mm Ø

Code	Alignment	N° tubes	Dimensions (LxAxH)
BJJ001	2x3	6	55x45x40 mm
BJJ002	1x6	6	112x38x40 mm
BJJ003	2x6	12	118x48x40 mm
BJJ004	1x12	12	250x44x40 mm
BJJ005	2x12	24	255x48x40 mm
BJJ006	1x24	24	490x50x40 mm
BJJ007	3x16	48	310x75x40 mm
BJJ008	5x10	50	195x105x40 mm
BJJ009	5x12	60	200x131x40 mm
BJJ010	10x10	100	195x195x40 mm
BJJ011	7x20	140	410x150x40 mm
BJJ012	10x15	150	291x195x40 mm



▶ For tubes of 16 mm Ø

Code	Alignment	N° tubes	Dimensions (LxAxH)
BJJ013	2x6	12	160x60x40 mm
BJJ014	2x12	24	268x65x40 mm
BJJ015	2x6	12	160x60x65 mm
BJJ016	2x12	24	268x65x65 mm



▶ BJJ - For tubes, PVC



▶ For tubes of 22 mm Ø



Code	Alignment	N° tubes	Dimensions (LxAxH)
BJJ017	2x6	12	182x68x65 mm
BJJ018	2x12	24	350x82x65
BJJ019	2x3	6	185x65x90 mm
BJJ020	2x6	12	182x68x90 mm
BJJ022	2x12	24	350x83x90 mm

▶ For tubes of 32 mm Ø



Code	Alignment	N° tubes	Dimensions (LxAxH)
BJJ023	2x3	6	130x90x65 mm
BJJ024	1x6	6	290x58x65 mm
BJJ025	2x4	8	185x95x65 mm
BJJ026	2x6	12	250x85x65 mm

▶ For tubes of 32 mm Ø



Code	Alignment	N° tubes	Ø tubes	Dimensions (LxAxH)
BJJ027	2x3	6	40 mm	177x120x60 mm
BJJ028	2x4	8	40 mm	250x130x60 mm
BJJ029	2x2	4	50 mm	150x150x60 mm
BJJ030	2x3	6	50 mm	220x150x60 mm
BJJ031	2x3	6	60 mm	220x152x60 mm

▶ BJL - For microtubes

▶ Polypropylene



- 1 | Alphanumerical graduation. Sterilizable in autoclave.
- 2 | Temperature in use: up to -20 °C.

Code	N° tubes	Ø tubes	Colour	Dimensions (LxAxH)
BJL001	60	0.5/1.5 mL	Orange	210x73x24 mm
BJL002	60	0.5/1.5 mL	Blue	210x73x24 mm
BJL003	60	0.5/1.5 mL	Green	210x73x24 mm
BJL004	60	0.5/1.5 mL	Red	210x73x24 mm

▶ BJN - For pipettes

▶ For pipettes and thermometres



- 1 | Capacity for 12 units, until 10 mm Ø.
- 2 | Made of PP.

Code	Capacity	Dimensions (LxAxH)
BJN009	12	205x150x220 mm



▶ Circular



- 1 | Made of white plastic. For pipettes of different volumen
- 2 | Capacity 44 pipettes

Code	Description	Capacity
BJN008	Fixed, without base	32 holes of 13 mm



▶ BJQ - For flasks

▶ Circular cork support



Code	Ø	For flasks	D1	D2	H
BJQ001	80 mm	50-100 mL	50 mm	30 mm	30 mm
BJQ002	100 mm	250 mL	65 mm	45 mm	30 mm
BJQ003	120 mm	500 mL	90 mm	70 mm	30 mm
BJQ004	140 mm	1000 mL	110 mm	90 mm	30 mm
BJQ005	160 mm	2000 mL	125 mm	110 mm	30 mm

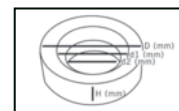

▶ Circular rubber



- 1 | Puede sujetar matraces de hasta 500 mL.

Code	Ø maximum	Height
BJQ006	90 mm	50 mm



▶ Circular PP



- 1 | For holding flasks up to 10L. MAde of polypropilene.

Code	Ø maximum	Height
BJQ007	160 mm	50 mm



▶ BJS - For funnels

▶ For 4 and 2 funnels, metal



1 | Made of metal, it is supplied with support

Code	Capacity
BJS005	2 funnels
BJS006	4 funnels

▶ BMC - Glass

▶ Glass stopper flat bottom



Code	Ground joint	Shape
BMC001	10/19	Hexagonal
BMC002	12/21	Hexagonal
BMC004	14/23	Hexagonal
BMC006	19/26	Hexagonal
BMC008	24/29	Hexagonal
BMC010	29/32	Hexagonal
BMC012	34/35	Hexagonal

▶ Glass stopper tip bottom



Code	Ground joint	Shape
BMC003	12/21	Hexagonal
BMC005	14/23	Hexagonal
BMC007	19/26	Hexagonal
BMC009	24/29	Hexagonal
BMC011	29/32	Hexagonal

▶ Ground joint with groove



Code	Ground joint	Description
BMC015	29/32	With groove
BMC016	14/23	-

▶ BMD - Forma cónica, goma

▶ Goma roja



Code	Lower Ø	Upper Ø	Height
BMD116	6 mm	9.5 mm	17,4 mm
BMD117	9.5 mm	12 mm	15,6 mm
BMD118	11 mm	14.5 mm	20,5 mm
BMD119	13 mm	16 mm	20,5 mm
BMD120	14 mm	17.5 mm	20,3 mm
BMD121	15 mm	19.5 mm	22,5 mm
BMD122	17 mm	21 mm	25,25 mm
BMD123	19.5 mm	24 mm	26,25 mm
BMD124	20.5 mm	28 mm	31,05 mm
BMD125	27.5 mm	32 mm	32,35 mm
BMD126	29 mm	34 mm	34,40 mm
BMD127	31.5 mm	39.5 mm	43,60 mm
BMD128	36.5 mm	43.5 mm	44,60 mm
BMD129	43.5 mm	53.5 mm	43,08 mm
BMD130	45 mm	56 mm	42,20 mm



▶ BMH - Perforated, rubber

▶ Goma roja, 1 y 2 orificios



Code	Holes	Lower Ø	Upper Ø	Height
BMH103	1 hole	15 mm	19.5 mm	22,25 mm
BMH104	1 hole	17 mm	21 mm	25,25 mm
BMH105	1 hole	19.5 mm	24 mm	26,25 mm
BMH106	1 hole	20.5 mm	28 mm	31,05 mm
BMH107	1 hole	27.5 mm	32 mm	32,35 mm
BMH108	1 hole	29 mm	34 mm	34,40 mm
BMH109	1 hole	31.5 mm	39.5 mm	43,60 mm
BMH110	1 hole	36.5 mm	43.5 mm	44,60 mm
BMH111	1 hole	43.5 mm	53.5 mm	43,08 mm
BMH112	1 hole	45 mm	56 mm	42,20 mm
BMH113	2 holes	15 mm	19.5 mm	22,25 mm
BMH114	2 holes	17 mm	21 mm	25,25 mm
BMH115	2 holes	19.5 mm	24 mm	26,25 mm
BMH116	2 holes	20.5 mm	28 mm	31,05 mm
BMH117	2 holes	27.5 mm	32 mm	32,35 mm
BMH118	2 holes	29 mm	34 mm	34,40 mm
BMH119	2 holes	31.5 mm	39.5 mm	43,60 mm
BMH120	2 holes	36.5 mm	43.5 mm	44,60 mm
BMH121	2 holes	43.5 mm	53.5 mm	43,08 mm
BMH122	2 holes	45 mm	56 mm	42,20 mm



▶ BML - Borers

▶ Cork borer sharpener

Code	Description	Total length
BML001	Hardened steel blade and metal handle	170 mm



▶ Cork borers

- Made of nickel plated brass, they present borers of different diameters.
- Equipped with a solid rod to remove the rests of cork from the borer.

Code	Set of	Range
BML002	6	5/11 mm
BML003	12	5/19 mm





BPB - Microscope slides

With cavities

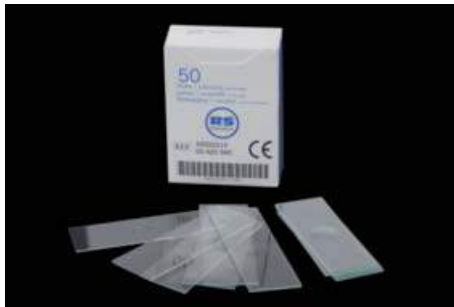

- 1 | Made of soda glass. Standard size 76x26 mm. Box of 50 units.
- 2 | Ground edges 90°.

Code	Cavities	Thickness
BPB001	1 cavidad	1,2 mm
BPB002	2 cavities	1,2 mm
BPB045	3 cavities	1,2/1,5 mm

3 fields for cytology



- 1 | 3 fields of 18 mm each one identified as (VCE).
- 2 | With frosted band of 20 mm. Ground edge 90°.
- 3 | Box of 50 units.

Code	Size
BPB005	76x26 mm

Colour end

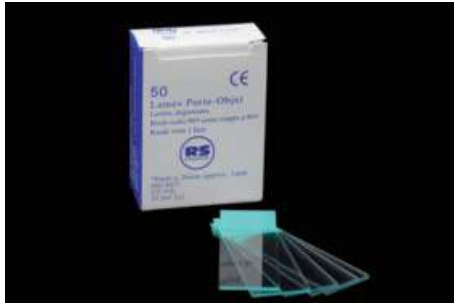

- 1 | Ground edges, box of 50 units.

Code	Dimensions	Corner	Thickness	Colour
BPB021	76x26 mm	45°	1/1,2	White
BPB022	76x26 mm	45°	1/1,2	Orange
BPB023	76x26 mm	45°	1/1,2	Yellow
BPB024	76x26 mm	45°	1/1,2	Green
BPB025	76x26 mm	45°	1/1,2	Pink
BPB026	76x26 mm	45°	1/1,2	Blue
BPB027	76x26 mm	90°	1/1,2	White
BPB028	76x26 mm	90°	1/1,2	Orange
BPB029	76x26 mm	90°	1/1,2	Yellow
BPB030	76x26 mm	90°	1/1,2	Green
BPB031	76x26 mm	90°	1/1,2	Pink
BPB032	76x26 mm	90°	1/1,2	Blue

Diagnostic



- 1 | Hydrophobic blue Teflon coating highly resistant to organic solvents and reagents used in Histology.
- 2 | Standard size 73x26 mm and thickness 1 mm .
- 3 | Ground edges 90° and frosted band 20 mm. Box of 50 units.

Code	N° Wells	Well Ø
BPB003	1 mm	6 mm
BPB004	2 mm	11 mm
BPB006	3 mm	10 mm
BPB007	3 mm	14 mm
BPB008	6 mm	8 mm
BPB009	8 mm	9 mm
BPB010	10 mm	5 mm
BPB011	10 mm	8 mm
BPB012	8 mm	6 mm numbered
BPB013	10 mm	6 mm numbered
BPB014	10 mm	8 mm numbered
BPB015	10 mm	7 mm numbered clockwise

 BPB - Microscope slides

 Standard

1 | Thickness 1/1.2 mm. Box of 50 units.

Code	Dimensions	Edges	Corner	Batch
BPB016	76x26 mm	Cut	90°	50
BPB017	76x26 mm	Ground	90°	50
BPB043	76x26 mm	Ground	45°	50

 Standard

GHÄASEL

1 | Hydrophilic treatment For human biology.
2 | Dimensions: 76x26 mm. Supplied in boxes of 50 units.

Code	Corner	Thickness	Edges	Batch
BPB033	90°	1,1	Cut	50
BPB034	90°	1,1	Ground	50
BPB035	45°	1,1	Ground	50

 Frosted band

1 | Thickness 1/1,2 mm. Supplied in boxes of 50 units

Code	Dimensions	Edges	Corner	Batch
BPB018	76x26 mm	Cut	90°	50
BPB019	76x26 mm	Ground	90°	50
BPB020	76x26 mm	Ground beveled	90°	50
BPB044	76x26 mm	Ground	45°	50

 Frosted band

GHÄASEL

1 | Hydrophilic treatment For human biology.
2 | Dimensions: 76x26 mm. Supplied in boxes of 50 units.

Code	Corner	Thickness	Edges	Batch
BPB036	90°	1,1	Cut	50
BPB037	90°	1,1	Ground	50

 Special dimensions

Zuzi

1 | Thickness of 1mm. Made of soda glas.
2 | Box of 50 units.

Code	Dimensions	Edges
BPB038	76x50 mm	Cut
BPB041	45x30 mm	Cut
BPB042	80x65 mm	Cut



▶ BPD - Cover slides

▶ Square/rectangular



- 1 | Made of soda glass, transparent and without finger-prints.
- 2 | Uniform standard thickness of 0.13-0.16 mm.
- 3 | Box of 100 units .

Code	Dimensions	Batch
BPD001	12x12 mm	10
BPD002	18x18 mm	10
BPD003	20x20 mm	10
BPD004	22x22 mm	10
BPD005	24x24 mm	10
BPD006	24x32 mm	10
BPD007	24x40 mm	5
BPD008	24x50 mm	5
BPD009	24x60 mm	5

▶ Round



- 1 | Made of soda glass, transparent and without finger-prints.
- 2 | Uniform standard thickness of 0.13-0.16 mm.
- 3 | Box of 100 units .

Code	Dimensions Ø	Batch
BPD010	10 mm	10
BPD011	12 mm	10
BPD013	18 mm	10
BPD014	20 mm	10
BPD015	22 mm	10

▶ Square

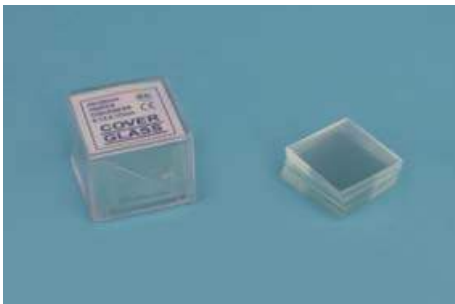

- 1 | Borosilicate glass.
- 2 | Thickness of 0.13/0.17 mm. Box of 200 units.
- 3 | ISO8255.

Code	Dimensions	Batch
BPD016	18x18 mm	5
BPD017	20x20 mm	5
BPD018	22x22 mm	5
BPD020	24x24 mm	5

▶ Rectangular

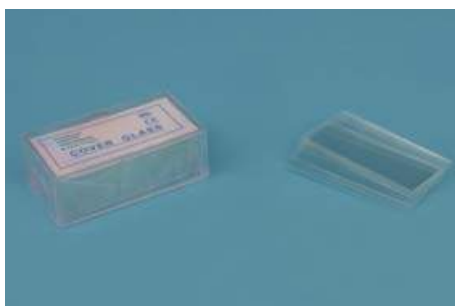

- 1 | Borosilicate glass.
- 2 | Thickness of 0.13/0.17 mm. Box of 100 units.
- 3 | ISO8255.

Code	Dimensions	Batch
BPD019	22x32 mm	10
BPD021	24x32 mm	10
BPD022	24x36 mm	10
BPD023	24x40 mm	10
BPD024	24x50 mm	10
BPD025	24x60 mm	10

▶ BPG - Storage boxes, microscope slides

▶ Cardboard trays



- 1 | For standard microscopes slides 76x26 mm.
- 2 | With thumb grooves to remove slides easily.

Code	N° slides	Description	Dimensions
BPG001	2	With lid	90x70x5 mm
BPG002	3	With lid	82x28x17 mm
BPG003	4	With lid	150x110x7mm
BPG004	10	With lid, index and numbered	400x100x7 mm
BPG005	20	With lid, index and numbered	400x200x7 mm
BPG006	20	Without lid, numbered	400x200x4 mm



▶ Plastic boxes



- 1 | For standard microscopes slides 76x26 mm.
- 2 | Biggest boxes can be stacked (50 and 100 slides).

Code	N° slides	Description	Dimensions
BPG007	2	Hinged opening	90x70x5 mm
BPG008	5	Hinged opening	82x28x17 mm
BPG009	25	2 pieces	120x80x30 mm
BPG010	50	Hinged opening, numbered	210x83x30 mm
BPG011	100	Hinged opening, numbered	210x163x30 mm



▶ Plastic boxes



- 1 | Made of ABS plastic, to get slides clean and free of finger prints.
- 2 | Capacity for 90 standard size slides: 76x26 mm.

Code	Dimensions
BPG012	12x10x16,5 cm



▶ Metallic storage cabinet for slides



- 1 | Modular system to classify and store slides.
- 2 | Each module is composed of 6 drawers with safety system.
- 3 | Stackable modules made of metal.

Code	Description	Capacity	Dimensions
BPG013	Base	-	40x46x11 cm
BPG014	Cabinet	5400 slides	48x40,5x12,5 cm



▶ BPG - Storage boxes, microscope slides

▶ Metallic storage cabinet for blocks



Nahita

- 1 | Modular system to classify and store paraffin blocks.
- 2 | Each module is composed of 6 drawers with safety system.
- 3 | Each drawer has 12 metallic removable guides.
- 4 | Stackable modules made of metal.

Code	Description	Capacity	Dimensions
BPG015	Base	-	48x45x12 cm
BPG016	Cabinet	4800 blocks	48x45x39 cm

▶ Storage box for slides, plastic



ENDO
plasticware

- 1 | Made of plastic, stackable.
- 2 | They include 6 supports for 75 slides (total capacity 450 slides).

Code	Description	Dimensions
BPG017	Storage box for 450 slides	34x23x10 cm
BPG018	Support for 75 slides	-

▶ BPJ - Embedding

▶ Embedding cassettes with lid



ENDO
plasticware

- 1 | Made of polyoxymethylene (POM), completely resistant to organic solvents.
- 2 | Large labelling surfaces, inclined 45°.

Code	Colour	Slots	Box
BPJ001	White	1x5 mm	500 uds.

▶ Biopsy cassettes with lid



ENDO
plasticware

- 1 | Made of polyoxymethylene (POM), completely resistant to organic solvents.
- 2 | Large labelling surfaces, inclined 45°.

Code	Colour	Slots	Box
BPJ006	White	1x1 mm	500 uds.

▶ Embedding cassettes without lid



ENDO
plasticware

- 1 | Made of polyoxymethylene (POM), completely resistant to organic solvents.
- 2 | Large labelling surfaces, inclined 45°.

Code	Colour	Slots	Box
BPJ011	White	11 mm Ø	500 uds.

▶ BPJ - Embedding

▶ Lid for cassettes



1 | Made of stainless steel. For embedding cassettes without lid.

Code
BPJ039

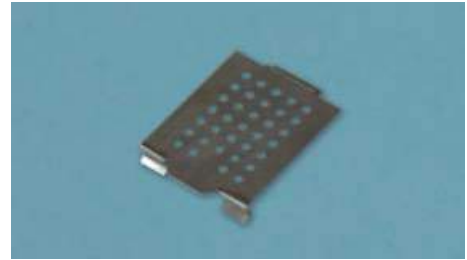

▶ Embedding ring



1 | Made of high quality ABS plastic.
2 | With labelling surface for proper sample identification.

Code	Colour	Ring dim.	Base dim.	Box
BPJ016	White	25X25 mm	40X28 mm	500 uds

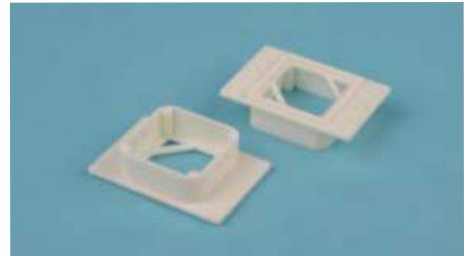

▶ Embedding moulds



1 | Made of stainless steel. Suitable to be used with embedding rings and cassettes.

Code	Dimensions
BPJ040	7x7x6 mm
BPJ041	15x15x6 mm
BPJ042	24x24x6 mm
BPJ043	30x24x6 mm



▶ BPL - Staining

▶ Hellendahl staining jar



1 | Made of highly resistant pressed glass.
2 | Glass lid.
3 | Capacity for 8 slides in vertical position.

Code	Description	For slides	Batch
BPL001	Jar	76x26mm	20



▶ BPL - Staining

▶ Shiefferdecker staining jar



- 1 | Made of highly resistant pressed glass.
- 2 | Glass lid.
- 3 | Capacity for 10 slides in vertical position.

Code	Description	For slides
BPL003	Jar	76x26mm

▶ Coplin staining jar



- 1 | Made of highly resistant pressed glass. Glass lid.
- 2 | Capacity for 5 slides in vertical position.

Code	Description	For slides
BPL005	Jar	76x26mm

▶ Staining jar



- 1 | Made of highly resistant pressed glass, with glass lid.
- 2 | Jar with tray and stainless steel handle.
- 3 | Capacity for 10 slides in horizontal position, 20 slides back to back.

Code	Description	Ext. dim.	Int. dim.
BPL010	Complete jar	85x70x105 mm	75x60x95 mm
BPL007	Jar	85x70x105 mm	75x60x95 mm
BPL008	Tray	90x68x45	-
BPL009	Handle	-	-

▶ Hausser Gedik staining jar

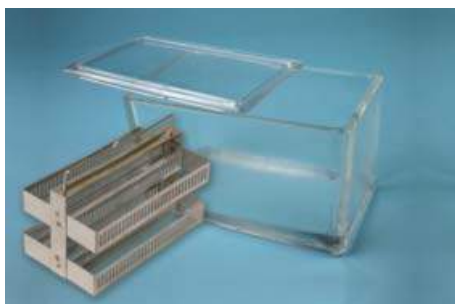

- 1 | Set of staining jar and stainless steel support (sold separately).
- 2 | Glass lid.

Code	Capacity	Description	Int. dimensions
BPL012	30	Jar	85x85x95 mm
BPL013	60	Jar	85x85x150 mm
BPL028	60	Support	-

▶ BPL - Staining

▶ Spot plates, porcelain



- 1| Highly resistant to acids, bases and thermal shock.
- 2| Glazed surface and sides, wells of 20 mm Ø and 5 mm deep approximately.

Code	N° wells	Length	Width
BPL014	6	85 mm	54 mm
BPL015	12	115 mm	90 mm



▶ BRB - Petri dishes

▶ Petri dish



- 1| Made of soda glass. Autoclavable
- 2| Bottom and lid are flat inside and outside. High transparency.

Code	Diameter	Height	Batch
BRB001	40 mm	12 mm	18
BRB002	60 mm	15 mm	18
BRB003	80 mm	15 mm	18
BRB004	100 mm	18 mm	18
BRB005	120 mm	20 mm	18
BRB006	150 mm	25 mm	18



▶ BRG - Inoculating loops

▶ Kolle handle



- 1| Includes 2 loops (Ni-Cr)

Code	Length	Handle	Batch
BRG009	200 mm	Plastic	10
BRG010	290 mm	Metal	10



▶ Koll handle, accessories



- 1| Made of Nickel Chromium

Code	Description	Total length	Batch
BRG011	Loop 3mm Ø	43 mm	50
BRG012	Needle	48 mm	50
BRG013	Lancet tip	59 mm	50



▶ BRJ - Counters

▶ Manual counter



Nahita

- 1 | Made of metal.
- 2 | Each touch adds a unit.
- 3 | 4 digits for a count up to 9999 cells or particles.

Code	Batch
BRJ001	10

▶ Digital counter



Nahita

- 1 | To count 10 different leukocyte types: basophils, eosinophils, monocytes, lymphocytes, mature and immature neutrophils, promyelocytes, etc.
- 2 | Functions: differential percentage, differential and total count.
- 3 | Count 0-100 for each cellular type. Each touch adds a unit to its screen and the total count.

Code	Power supply
BRJ002	220 V / 50 Hz

▶ BTB - Plastic trays

▶ Stackable trays, HDPE



ENDO
plasticware

- 1 | Made of high density polyethylene.

Code	Capacity	Ext. dimensions	Int. dimensions
BTB017	10 L	430x320x95 mm	390x290x90 mm
BTB018	16 L	540x350x110 mm	515x325x100 mm
BTB019*	16 L	540x350x110 mm	515x325x100 mm

* with draining holes

▶ Stackable trays, HDPE



ENDO
plasticware

- 1 | White colour, tall form.

Code	Capacity	Ext. dimensions	Int. dimensions.
BTB013	100 L	600x500x445 mm	535x450x430 mm
BTB014	20 L	440x315x200 mm	380x280x195 mm
BTB015	50 L	625x365x285 mm	560x330x280 mm
BTB016	80 L	725x440x330 mm	650x380x320 mm

▶ Bucket with spout, LDPE



ENDO
plasticware

- 1 | Graduated.
- 2 | Suitable for contact with food.

Code	Capacity	Upper Ø	Lower Ø	Height
BTB030	9 L	270 mm	200 mm	250 mm
BTB028	12 L	302 mm	220 mm	280 mm
BTB029	17 L	335 mm	245 mm	310 mm

▶ BTD - Glass jars

▶ Aquarium jar



1 | Ground edge.

Code	Height	Lenght	Depth
BTD001	100 mm	100 mm	100 mm
BTD002	100 mm	100 mm	150 mm
BTD003	100 mm	100 mm	200 mm
BTD005	120 mm	130 mm	95 mm
BTD006	150 mm	100 mm	150 mm
BTD007	150 mm	220 mm	300 mm
BTD008	160 mm	160 mm	300 mm
BTD009	180 mm	130 mm	180 mm
BTD010	200 mm	150 mm	200 mm
BTD011	220 mm	180 mm	250 mm
BTD012	240 mm	220 mm	300 mm
BTD013	260 mm	230 mm	360 mm



▶ Rectangular jars



1 | Ground edge.

Code	Height	Lenght	Depth
BTD014	100 mm	50 mm	50 mm
BTD015	100 mm	80 mm	60 mm
BTD018	150 mm	105 mm	50 mm
BTD019	150 mm	80 mm	60 mm
BTD023	200 mm	130 mm	80 mm
BTD016	120 mm	105 mm	50 mm
BTD017	150 mm	100 mm	100 mm
BTD020	200 mm	100 mm	100 mm
BTD022	200 mm	130 mm	130 mm
BTD024	225 mm	200 mm	100 mm
BTD021	200 mm	120 mm	120 mm



▶ Lid for rectangular jars.

Code	Dimensions
BTD025	50x50 mm
BTD026	80x60 mm
BTD027	105x50 mm
BTD028	130x80 mm
BTD029	100x100mm
BTD030	130x130 mm
BTD031	200x100 mm

▶ Cylindrical jars



Code	Diameter	Height
BTD032	80 mm	80 mm
BTD033	100 mm	100mm
BTD034	100 mm	150 mm
BTD035	100 mm	200 mm
BTD036	100 mm	250 mm
BTD037	100 mm	300 mm
BTD038	120 mm	120 mm
BTD039	150 mm	150 mm
BTD040	150 mm	220 mm
BTD041	150 mm	300 mm
BTD044	200 mm	150 mm
BTD045	200 mm	200 mm
BTD046	200 mm	250 mm
BTD048	250 mm	200 mm
BTD049	250 mm	250 mm
BTD042	150 mm	80 mm
BTD043	200 mm	100mm
BTD047	230 mm	100 mm
BTD050	300 mm	250 mm
BTD051	350 mm	250 mm



▶ BTQ - Boxes, SS

Nahita



Code	Dimensions
BTQ001	170x70x30 mm

▶ BTS - Stainless steel baskets

Nahita



- 1 | For transport, autoclave and ultrasound bath cleaning.
- 2 | With thin grid: 5 mm.

Code	Description	Dimensions	Height
BTS001	Round	150 mm	150 mm
BTS002	Round	200 mm	200 mm
BTS003	Round	250 mm	250 mm
BTS004	Square	150x150 mm	150 mm
BTS005	Square	200x200 mm	200 mm
BTS006	Square	250x250 mm	250 mm

▶ BYF - Transport/storage of samples

▶ Freezing box for centrifuge tubes

Nahita



- 1 | Cardboard boxes, they have a printed grid to identify samples.

Code	Tubes	Dimensions	Batch
BYF001	16*x50 mL	140,6x140,6x120,2 mm	48
BYF002	49x15 mL	130,5x130,5x110,5 mm	36

* capless

▶ Freezing box for microtubes

Nahita



- 1 | Autoclavable polypropylene with transparent lid.
- 2 | For microtubes of 0.2 mL.

Code	Capacity	Dimensions
BYF003	96 (8x12)	12,6x8,8x3,1 cm

▶ Racks for vertical freezers



Code	Boxes	Height	Dimensions
BYF066	3x3	50 mm	140x420x165 mm
BYF067	4x3	50 mm	140x420x223 mm
BYF068	5x3	50 mm	140x420x277 mm
BYF069	4x4	50 mm	140x560x223 mm
BYF070	5x4	50 mm	140x560x277 mm
BYF071	3x3	75 mm	140x420x245 mm
BYF072	3x4	75 mm	140x560x245 mm
BYF073	2x3	95 mm	140x420x200 mm
BYF074	2x4	95 mm	140x560x200 mm
BYF075	2x3	125 mm	140x420x265 mm
BYF076	2x4	125 mm	140x560x265 mm

▶ BYF - Transport/storage of samples

▶ Racks for horizontal freezers

Code	Floors	Height	Dimensions
BYF047	5	50 mm	140x140x280 mm
BYF048	7	50 mm	140x140x390 mm
BYF049	8	50 mm	140x140x445 mm
BYF050	9	50 mm	140x140x500 mm
BYF051	10	50 mm	140x140x555 mm
BYF052	11	50 mm	140x140x610 mm
BYF053	12	50 mm	140x140x665 mm
BYF054	13	50 mm	140x140x720 mm
BYF055	5	75 mm	140x140x405 mm
BYF056	6	75 mm	140x140x485 mm
BYF057	7	75 mm	140x140x565 mm
BYF058	8	75 mm	140x140x645 mm
BYF059	9	75 mm	140x140x725 mm
BYF060	4	95 mm	140x140x400 mm
BYF061	5	95 mm	140x140x500 mm
BYF062	6	95 mm	140x140x600 mm
BYF063	7	95 mm	140x140x700 mm
BYF064	4	125 mm	140x140x525 mm
BYF065	5	125 mm	140x140x655 mm



▶ Racks with removable trays

Code	Boxes	Height	Size	Boxes up to
BYF024	2x3	52 mm	140x420x116 mm	133x133 mm
BYF025	2x4	52 mm	140x555x116 mm	133x133 mm
BYF026	3x3	52 mm	140x420x174 mm	133x133 mm
BYF027	3x4	52 mm	140x555x174 mm	133x133 mm
BYF028	4x3	52 mm	140x420x233 mm	133x133 mm
BYF029	4x4	52 mm	140x555x233 mm	133x133 mm
BYF030	5x3	52 mm	140x420x290 mm	133x133 mm
BYF031	5x4	52 mm	140x555x290 mm	133x133 mm
BYF032	6x3	52 mm	140x420x349 mm	133x133 mm
BYF033	6x4	52 mm	140x555x349 mm	133x133mm
BYF034	7x3	52 mm	140x420x406 mm	133x133mm
BYF035	7x4	52 mm	140x555x406 mm	133x133 mm
BYF036	3x3	50 mm	143x440x170 mm	135x135 mm
BYF037	4x3	50 mm	143x440x230 mm	135x135 mm
BYF038	5x3	50 mm	143x440x285 mm	135x135 mm
BYF039	4x4	50 mm	143x580x230 mm	135x135 mm
BYF040	5x5	50 mm	143x580x285 mm	135x135 mm
BYF041	3x3	75 mm	143x440x250mm	135x135 mm
BYF042	3x4	75 mm	143x580x250 mm	135x135 mm
BYF043	2x3	95 mm	143x440x210 mm	135x135 mm
BYF044	2x4	95 mm	143x580x210 mm	135x135 mm
BYF045	2x3	125 mm	143x440x275 mm	135x135 mm
BYF046	2x4	125 mm	143x580x275 mm	135x135 mm



▶ Freezing box for cryotubes



- 1| With transparent lid, made of polycarbonate.
- 2| Numbered positions in lid and base.

Code	Capacity	Dimensions	Colour
BYF017	81 tubesx1.8 mL	133x13x52 mm	Red
BYF018	81 tubesx1.8 mL	133x13x52 mm	Green
BYF019	81 tubesx1.8 mL	133x13x52 mm	Yellow
BFY020	81 tubesx1.8 mL	133x13x52 mm	Blue

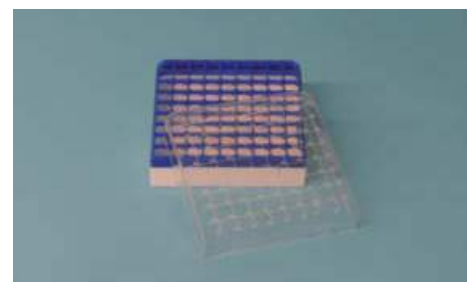

LABORATORY
SUPPLIERS

TRADEMARKS

COMPETITIVITY

SERVICES

STOCK

PRODUCT
RANGE

**WE REPRESENT
LEADING BRANDS
IN THE MARKET**

AUXILAB S.L.

Material de laboratorio
Laboratory supplies



ROGO-SAMPAIC
matériel de laboratoire

SOCOREX
SWISS



SIMAX
CZECH REPUBLIC



Kartell



SAINT-GOBAIN
PERFORMANCE PLASTICS



**AUXILAB
+ ROGO
SAMPAIC**

**YOUR BIG LOGISTIC PLATFORM
OF LABORATORY SUPPLIES
AND EQUIPMENT**



[C] INDEX BEAKERS, FLASKS AND OTHER CONTAINERS

[CB] Beakers	36	[CJ] Dropping bottles	51
CBB - Glass, tall form	36	CJC - Glass	51
CBC - Glass, low form	36	[CK] Wash bottles	51
CBD - Glass, conical shape	38	CKD - Narrow mouth	51
CBH - Plastic, moulded grad	38	CKL - Stoppers	51
CBM - Porcelain, tall form	38	[CL] Tanks	51
CBN - Porcelain, low form	39	CLD - With dispenser, plastic	51
[CC] Jars	39	CLG - Without dispenser, plastic	53
CCB - Plastic, moulded grad	39	[CM] Vials	53
CCL - Porcelain	39	CMB - Injection	53
[CD] Flasks	40	CMD - For pills	53
CDB - Erlenmeyer, glass	40	CML - Closures for vials	54
CDG - Flat bottom, glass	41	[CN] Evaporation	54
CDJ - Round bottom, glass	41	CNB - Capsules, flat, porcelain	54
[CF] ISO bottles	42	CNG - Capsules, round, porcelain	54
CFB - Clear glass	42	CNK - Capsules with handle, porcelain	55
CFD - Amber glass	43	CNL - Evap. dishes with spout, glass	56
[CG] Bottles, threaded stopper	44	CNN - Evap. dishes without spout, glass	56
CGB - Wide mouth, glass	44	[CP] Incineration	57
CGD - Wide mouth, plastic	44	CPB - Crucibles, tall form, porcelain	57
CGG - Narrow mouth, glass	46	CPC - Crucibles, medium form, porcelain	57
CGJ - Narrow mouth, plastic	47	CPD - Crucibles, low form, porcelain	58
CGL - Stoppers f/glass bottles	49	CPF - Crucibles, lids, porcelain	58
CGN - Stoppers f/plastic bottles	50	CPK - Incineration capsules	59
[[CH] Bottles, NS stopper	50	CPL - Incineration cuvettes	60
CHB - Wide mouth, glass	50	CPN - Combustion boats	60
CHG - Narrow mouth, glass	50		

TRADEMARKS:



▶ CBB - Glass, tall form

▶ Beakers, with spout



- 1 | Borosilicate glass, graduated
- 2 | According to ISO 3819

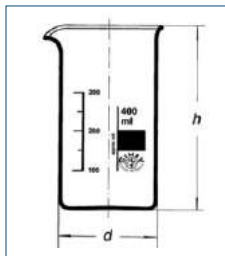

Code	Capacity	Diameter	Height	Batch
CBB001	25 mL	30 mm	55 mm	10
CBB002	50 mL	38 mm	70 mm	10
CBB003	100 mL	48 mm	80 mm	10
CBB004	150 mL	54 mm	95 mm	10
CBB005	250 mL	60 mm	120 mm	10
CBB006	400 mL	70 mm	130 mm	10
CBB007	600 mL	80 mm	150 mm	10
CBB008	800 mL	90 mm	175 mm	10
CBB009	1000 mL	95 mm	180 mm	10
CBB010	2000 mL	120 mm	240 mm	6
CBB011	3000 mL	135 mm	280 mm	6

▶ Beakers, with spout



- 1 | Borosilicate glass, graduated
- 2 | According to ISO 3819



Code	Capacity	Diameter	Height	Batch
CBB012	25 mL	30 mm	60 mm	12
CBB013	50 mL	38 mm	70 mm	12
CBB014	100 mL	48 mm	80 mm	12
CBB015	150 mL	54 mm	95 mm	12
CBB016	250 mL	60 mm	120 mm	8
CBB017	400 mL	70 mm	130 mm	8
CBB018	600 mL	80 mm	150 mm	8
CBB019	1000 mL	95 mm	180 mm	6
CBB020	2000 mL	-	-	8

▶ CBC - Glass, low form

▶ Beakers, intensive use



- 1 | Made of borosilicate glass
- 2 | Reinforced edges and thick walls
- 3 | Double inverse graduation

Code	Capacity	Diameter	Height
CBC009	150 ml	55 mm	90 mm
CBC010	250 ml	68 mm	90 mm
CBC011	400 ml	79 mm	110 mm
CBC012	600 ml	89 mm	123 mm
CBC013	1000 ml	105 mm	152 mm
CBC014	2000 ml	130 mm	196 mm

▶ CBC - Glass, low form

▶ Beakers, with spout



- 1 | Made of borosilicate glass, graduated
- 2 | According to ISO 3819

Code	Capacity	Diameter	Height	Batch
CBC015	25 mL	35 mm	55 mm	12
CBC016	50 mL	43 mm	60 mm	12
CBC017	100 mL	51 mm	71 mm	12
CBC018	150 mL	61 mm	86 mm	12
CBC019	250 mL	70 mm	98 mm	8
CBC020	400 mL	79 mm	115 mm	8
CBC021	600 mL	90 mm	125 mm	8
CBC022	800 mL	100 mm	135 mm	6
CBC023	1000 mL	105 mm	145 mm	6
CBC024	2000 mL	130 mm	185 mm	2
CBC025	3000 mL	150 mm	210 mm	-
CBC026	5000 mL	170 mm	270 mm	-

page
[37]

▶ Boudreau beaker



Code	Capacity
CBC043	500 mL



▶ Beakers, with spout



- 1 | Made of borosilicate glass, graduated
- 2 | According to ISO 3819

Code	Capacity	D (diameter)	H (height)	Batch
CBB027	5 mL	22 mm	30 mm	10
CBB028	10 mL	26 mm	35 mm	10
CBB029	25 mL	34 mm	50 mm	10
CBB030	50 mL	42 mm	60 mm	10
CBB031	100 mL	50 mm	70 mm	10
CBB032	150 mL	60 mm	80 mm	10
CBB033	250 mL	70 mm	95 mm	10
CBB034	400 mL	80 mm	110 mm	10
CBB035	600 mL	90 mm	125 mm	10
CBB036	800 mL	100 mm	135 mm	10
CBB037	1000 mL	105 mm	145 mm	10
CBB038	2000 mL	130 mm	185 mm	4
CBB039	3000 mL	150 mm	210 mm	4
CBB040	5000 mL	170 mm	270 mm	2
CBB041*	10 L	217 mm	350 mm	-

* out of standard



▶ CBD - Glass, forma cónica

▶ Graduated cone-shape glass



1 | Wide and stable base. With spout

Code	Capacity	Diameter	Height
CBD001	50 mL	45 mm	145 mm
CBD002	1000 mL	130 mm	330 mm
CBD003	2000 mL	160 mm	370 mm

▶ Graduated cone-shape glass, thick glass



1 | With raised graduation.

Code	Capacity
CBD004	60 mL
CBD005	125 mL
CBD006	250 mL
CBD007	500 mL

▶ CBH - Plastic, moulded graduation

▶ Beakers low form, PP



1 | Made of polypropylene, with spout
2 | Permanently moulded graduation.

Code	Cap.	Graduation	Height	Ø	Batch
CBH001	50 mL	10 mL	60 mm	42 mm	10
CBH002	100 mL	20 mL	70 mm	54 mm	10
CBH003	250 mL	50 mL	100 mm	71 mm	10
CBH004	500 mL	100 mL	120 mm	92 mm	10
CBH005	1000 mL	100 mL	145 mm	110 mm	6

▶ CBM - Porcelain, tall form



1 | With spout

Code	Diameter	Volume	Height
CBM001	52 mm	170 mL	90 mm
CBM002	57 mm	225 mL	106 mm
CBM003	70 mm	450 mL	143 mm
CBM004	101 mm	1100 mL	157 mm

▶ CBN - Porcelain, low form



▶ Porcelain beakers, low form

1 | With spout

Code	Diameter	Volume	Height
CBN001	70 mm	275 mL	85 mm
CBN002	80 mm	400 mL	99 mm
CBN003	90 mm	620 mL	116 mm
CBN004	100 mm	860 mL	129 mm
CBN005	123 mm	950 mL	100 mm



page
[39]

▶ CCB - Plastic, moulded graduation

▶ Tall form, PP



- 1 | Polypropylene, moulded graduation
- 2 | Autoclavable at 121°C during 20 minutes
- 3 | With spout and handle for an easy grip

Code	Capacity	Batch
CCB001	250 mL	12
CCB002	500 mL	12
CCB003	1000 mL	6
CCB004	2000 mL	6



▶ Low form, PP



- 1 | Polypropylene, moulded graduation
- 2 | Autoclavable
- 3 | With spout and handle for an easy grip

Code	Capacity	Batch
CCB005	250 mL	12
CCB006	500 mL	10
CCB007	1000 mL	6
CCB008	2000 mL	6
CCB009	3000 mL	6
CCB010	5000 mL	4



▶ CCL - Porcelain



Code	Diameter	Volume	Height
CCL001	71 mm	100 mL	72 mm
CCL002	82 mm	250 mL	96 mm
CCL003	97 mm	500 mL	131 mm
CCL004	127 mm	1000 mL	160 mm

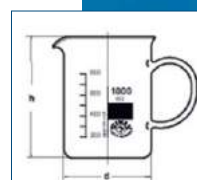

CDB - Erlenmeyer, glass

Narrow neck

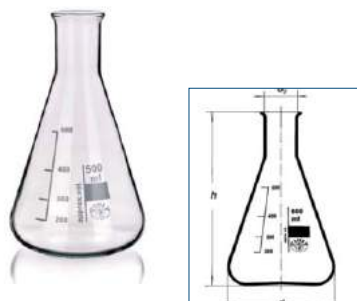

1 | According to ISO 1773

Code	Cap.	D1	D2	Height	Batch
CDB001	25 ml	42 mm	22 mm	75 mm	10
CDB002	50 ml	51 mm	22 mm	90 mm	10
CDB003	100 ml	64 mm	22 mm	105 mm	10
CDB004	200 ml	79 mm	34 mm	135 mm	
CDB005	250 ml	85 mm	34 mm	145 mm	10
CDB007	500 ml	105 mm	34 mm	180 mm	10
CDB008	1000 ml	131 mm	42 mm	220 mm	10
CDB009	2000 ml	166 mm	50 mm	280 mm	6
CDB010	3000 ml	187 mm	50 mm	310 mm	6
CDB011	5000 ml	220 mm	50 mm	365 mm	2

Narrow neck



1 | Narrow neck
2 | Borosilicate glass. Marking area

Code	Cap.	Base Ø	Neck Ø	Height	Batch
CDB012	25 mL	45 mm	18 mm	70 mm	24
CDB013	50 mL	55 mm	23 mm	80 mm	12
CDB014	100 mL	65 mm	30 mm	110 mm	12
CDB015	250 mL	85 mm	32 mm	140 mm	12
CDB016	500 mL	105 mm	35 mm	185 mm	8
CDB017	1000 mL	130 mm	44 mm	215 mm	6
CDB018	2000 mL	170 mm	40 mm	290 mm	2
CDB019	3000 mL	190 mm	40 mm	310 mm	-

Reinforced rim



1 | Narrow neck reinforced rim, borosilicate glass
2 | Marking surface

Code	Capacity	Base Ø	Neck Ø	Height
CDB020	50 mL	51 mm	22 mm	85 mm
CDB021	100 mL	64 mm	22 mm	105 mm
CDB022	250 mL	85 mm	34 mm	140 mm
CDB023	500 mL	105 mm	34 mm	175 mm
CDB024	1000 mL	131 mm	42 mm	220 mm
CDB051	2000 mL	-	-	-

Wide neck



1 | Wide neck, borosilicate glass
2 | Marking area

Code	Capacity	Base Ø	Neck Ø	Height
CDB025	50 mL	51 mm	34 mm	85 mm
CDB026	100 mL	64 mm	34 mm	110 mm
CDB027	250 mL	85 mm	50 mm	140 mm
CDB028	500 mL	105 mm	50 mm	170 mm
CDB029	1000 mL	131 mm	50 mm	200 mm

▶ CDB - Erlenmeyer, glass

▶ Wide neck



1 | According to ISO 24450

Code	Cap.	D1	D2	Height	Batch
CDB030	25 ml*	42 mm	22 mm	75 mm	10
CDB031	50 ml	51 mm	22 mm	90 mm	10
CDB032	100 ml*	64 mm	22 mm	105 mm	10
CDB033	250 ml*	79 mm	34 mm	135 mm	
CDB034	200 ml	85 mm	34 mm	145 mm	10
CDB036	1000 ml	131 mm	42 mm	220 mm	10
CDB037	2000 ml	166 mm	50 mm	280 mm	6
CDB038	2000 ml*	187 mm	50 mm	310 mm	6

* These capacities do not correspond to ISO, DIN



page
[41]

▶ CDG - Flat bottom, glass

▶ Narrow neck



1 | Made of borosilicate glass with white marking surface

Code	Cap.	d1	d2	H	Batch
CDG001	50 mL	50 mm	22 mm	105 mm	10
CDG002	100 mL	65 mm	22 mm	108 mm	12
CDG003	250 mL	85 mm	34 mm	140 mm	6
CDG004	500 mL	105 mm	34 mm	180 mm	6
CDG005	1000 mL	135 mm	43 mm	210 mm	6
CDG006	2000 mL	160 mm	52 mm	250 mm	-
CDG007	3000 mL	188 mm	59 mm	282 mm	-

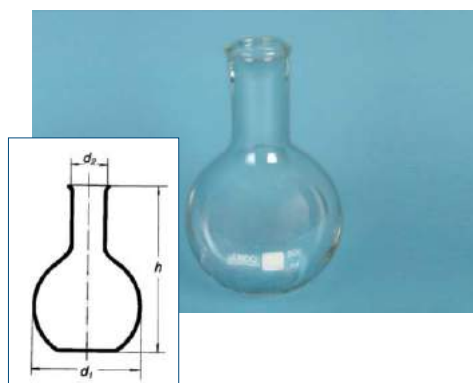

▶ CDJ - Round bottom, glass

▶ Narrow neck



1 | Made of borosilicate glass. White marking area

Code	Cap.	D1	D2	H	Batch
CDJ001	50 ml	50 mm	22 mm	105 mm	12
CDJ002	100 ml	65 mm	22 mm	108 mm	8
CDJ003	250 ml	85 mm	34 mm	140 mm	6
CDJ004	500 ml	105 mm	34 mm	180 mm	6
CDJ005	1000 ml	135 mm	43 mm	210 mm	2
CDJ006	2000 ml	175 mm	50 mm	270 mm	-
CDJ007	5000 mL	230 mm	56 mm	345 mm	-

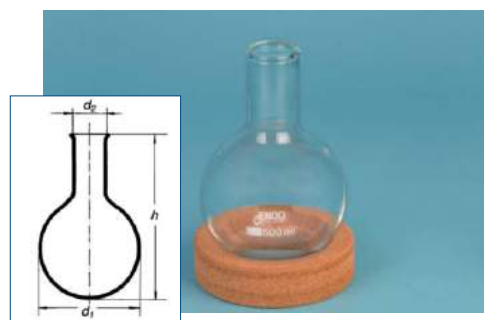



CFB - Transparent glass

▶ ISO, ECO blue cap



- 1 | Made of soda glass
- 2 | Blue PP outlet ring and cap. White graduation and marking area
- 3 | ISO 4796. DIN GL45 thread

Code	Capacity	Base Ø	Height	Batch
CFB001	100 ml	56 mm	105 mm	12
CFB002	250 ml	70 mm	143 mm	12
CFB003	500 ml	86 mm	182 mm	12
CFB004	1000 ml	101 mm	203 mm	10

▶ ISO bottle red cap and ring



- 1 | Made of borosilicate glass, graduated
- 2 | DIN GL45 screw cap, silicon lid
- 3 | PBT outlet ring and stopper (heat resistant up to 200°C)
- 4 | ISO 4796-1

Code	Cap.	GL	Ø	Height	Batch
CFB005	100 ml	45	56 mm	105 mm	10
CFB006	250 ml	45	70 mm	143 mm	10
CFB007	500 ml	45	86 mm	181 mm	10
CFB008	1000 ml	45	101 mm	230 mm	10
CFB010	3800 ml	45	160 mm	320 mm	-

▶ ISO bottle blue cap and ring



- 1 | Made of borosilicate glass, graduated
- 2 | DIN GL45 screw cap
- 3 | PP outlet ring and cap (heat resistant up to 140°C)
- 4 | ISO 4796-1

Code	Cap.	GL	Ø	Height	Batch
CFB023	50 mL	32	46 mm	91 mm	10
CFB014	100 mL	45	56 mm	105 mm	10
CFB015	250 mL	45	70 mm	143 mm	10
CFB016	500 mL	45	86 mm	181 mm	10
CFB017	1000 mL	45	101 mm	230 mm	10
CFB018	2000 mL	45	136 mm	265 mm	10
CFB019	3800 mL	45	160 mm	320 mm	-
CFB020	5000 mL	45	181 mm	336 mm	6
CFB021	10000 mL	45	227 mm	416 mm	-
CFB022	20000 mL	45	288 mm	512 mm	-

CFB - Transparent glass

▶ ISO bottle blue cap and ring, GL80



- 1 | Made of borosilicate glass, graduated. Non autoclavable
- 2 | DIN GL80 screw cap; oval shape
- 3 | ISO 4796-1

Code	Cap.	GL	Dimensions	Height	Batch
CFB024	500 ml	80	94x94 mm	139 mm	10
CFB025	1000 ml	80	105x105 mm	185 mm	10
CFB026	2000 ml	80	225x115 mm	258 mm	10
CFB027	5000 ml	80	160x160 mm	357 mm	10

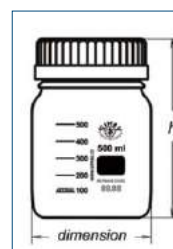
page
[43]

▶ ISO bottles, plastic coated



- 1 | Plastic coated to provide a higher protection against breaks, liquid leaks and light. Ideal for dangerous substances
- 2 | For a working temperature between -30°C and +135°C

Code	Capacity	GL	Ø	Height
CFB028	100 mL	45	56 mm	105 mm
CFB029	250 mL	45	70 mm	143 mm
CFB030	500 mL	45	86 mm	181 mm
CFB031	1000 mL	45	101 mm	230 mm
CFB032	2000 mL	45	136 mm	256 mm



▶ ISO bottles, for pressure



- 1 | Resistant to pressure from -1 to +1.5 bar
- 2 | Heat resistant up to 135°C

Code	Capacity	GL	Ø	Height
CFB033	1000 mL	45	108 mm	236 mm
CFB034	2000 mL	45	143 mm	266 mm



CFD - Amber glass

▶ ISO bottle blue cap and ring



- 1 | Made of amber borosilicate glass, graduated
- 2 | DIN GL45 screw cap
- 3 | PP pouring ring and cap (heat resistant up to 140°C)
- 4 | ISO 4796-1

Code	Cap.	GL	Ø	Height	Batch
CFD011	50 ml	32	46 mm	91 mm	10
CFD001	100 mL	45	56 mm	105 mm	10
CFD002	250 mL	45	70 mm	143 mm	10
CFD003	500 mL	45	86 mm	182 mm	10
CFD004	1000 mL	45	101 mm	203 mm	10
CFD005	2000 mL	45	136 mm	260 mm	10
CFD006	3800 mL	45	160 mm	320 mm	-
CFD007	5000 mL	45	181 mm	330 mm	6
CFD008	10000 mL	45	227 mm	410 mm	-
CFD009	20L	45	288 mm	512 mm	-

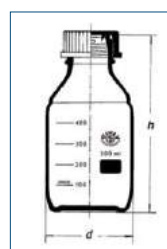

CFD - Amber glass

ISO bottle blue cap and ring, GL80

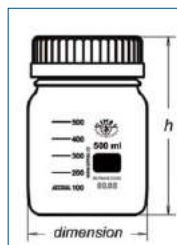

- 1 | Made of amber borosilicate glass, graduated. Non autoclavable
- 2 | DIN GL80 screw cap; oval shape
- 3 | PP outlet ring and cap (heat resistant up to 140°C)
- 4 | ISO 4796-1

Code	Cap.	Dimensions	Height	Batch
CFD012	500 ml	94x94 mm	139 mm	10
CFD013	1000 ml	105x105 mm	185 mm	10
CFD014	2000 ml	115x115 mm	258 mm	10
CFD015	5000 ml	160x160 mm	357 mm	10

CGB - Wide neck

Tins with metal lid



- 1 | Flat base and wide neck

Code	Capacity	Height	Neck Ø	Batch
CGB001	125 mL	50 mm	60 mm	210
CGB002	250 mL	90 mm	70 mm	120
CGB003	500 mL	110 mm	70 mm	60
CGB004	1000 mL	170 mm	70 mm	36
CGB005	2000 mL	210 mm	100 mm	24
CGB006	4000 mL	260 mm	100 mm	12

CGD - Wide neck, plastic

Graduated wide neck bottle



- 1 | Made of high density polyethylene, neutral colour
- 2 | Product suitable for contact with food

Code	Capacity	Graduation	Height	Neck Ø
CGD052	50 ml	10 mL	77 mm	24 mm
CGD053	100 ml	20 mL	89 mm	24 mm
CGD054	250 ml	25 mL	126 mm	34.5 mm
CGD055	500 ml	50 mL	161 mm	34.5 mm
CGD056	1000 ml	100 mL	201 mm	45 mm
CGD057	2000 ml	100 mL	250 mm	45 mm

Square graduated bottles



- 1 | Made of high density polyethylene, neutral colour
- 2 | Product suitable for contact with food

Code	Cap.	Grad.	Dim.	Neck Ø
CGD058	25 ml	5 mL	30x32 mm	18.5 mm
CGD059	50 ml	10 mL	35x37 mm	24 mm
CGD060	100 ml	20 mL	44x47 mm	34.5 mm
CGD061	250 ml	50 mL	57x60 mm	34.5 mm
CGD062	500 ml	100 mL	70x80 mm	45 mm
CGD063	1000 ml	100 mL	82x102 mm	60 mm
CGD064	2000 ml	100 mL	100x134 mm	60 mm

CGD - Wide neck, plastic

Cylindrical jar with ribbed cap



- 1 | Made of high density polyethylene, neutral colour
- 2 | Product suitable for contact with food

Code	Capacity	Diameter	Height	Neck Ø
CGD043	70 ml	50 mm	60 mm	36 mm
CGD044	120 ml	57 mm	70 mm	36 mm
CGD045	250 ml	67 mm	90 mm	50 mm
CGD046	500 ml	91 mm	103 mm	70 mm
CGD047	1000 ml	110 mm	127 mm	86 mm
CGD048	2000 ml	125 mm	185 mm	85 mm



Wide neck bottles, PE



- 1 | Made of high density polyethylene, neutral colour
- 2 | Product suitable for contact with food

Code	GL	Cap.	Neck Ø	Height	Batch
CGD066	32	50 ml	24 mm	77 mm	500
CGD068	32	100 ml	24 mm	92 mm	500
CGD067	40	250 ml	31 mm	123 mm	200
CGD065	50	500 ml	38,5 mm	153 mm	100
CGD069	65	1000 ml	50 mm	202 mm	100
CGD070	65	2000 ml	50 mm	243 mm	50



Wide neck bottles, PP



- 1 | Made of polypropylene, neutral colour
- 2 | Product suitable for contact with food

Code	GL	Cap.	Neck Ø	Height	Batch
CGD071	32	50 ml	24 mm	77 mm	500
CGD072	32	100 ml	24 mm	92 mm	500
CGD073	40	250 ml	31 mm	123 mm	200
CGD074	50	500 ml	38.5 mm	153 mm	100
CGD075	65	1000 ml	50 mm	202 mm	100
CGD076	65	2000 ml	50 mm	243 mm	-



Bottles with sealing cap



- 1 | Made of high density polyethylene, neutral colour
- 2 | Product suitable for contact with food

Code	Capacity	Diameter	Height	Neck Ø
CGD049	250 ml	60 mm	140 mm	30 mm
CGD050	500 ml	74 mm	179 mm	30 mm
CGD051	1000 ml	90 mm	218 mm	30 mm



▶ CGG - Narrow neck, glass

DIN28, thread dimensions

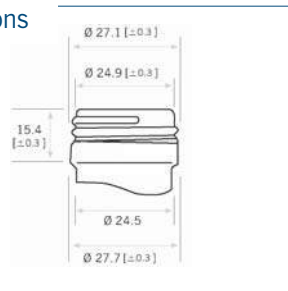

▶ DIN28, transparent



- 1 | Made of soda glass type III
- 2 | Meet European Pharmacopoeia and United States specifications

Code	Cap.	Height	Base Ø	Batch
CGG001	30 mL	67 mm	35 mm	108
CGG002	60 mL	94 mm	39 mm	88
CGG003	125 mL	114 mm	49 mm	60
CGG004	250 mL	143 mm	62 mm	49
CGG005	500 mL	177 mm	77 mm	30
CGG006	1000 mL	216 mm	97 mm	20

* check available caps

▶ DIN28, amber



- 1 | Made of soda glass type III
- 2 | Meet European Pharmacopoeia and United States specifications

Code	Cap.	Height	Base Ø	Batch
CGG007	30 mL	67 mm	35 mm	110
CGG008	60 mL	94 mm	39 mm	100
CGG009	100 mL	114 mm	49 mm	72
CGG010	125 mL	114 mm	49 mm	70
CGG011	250 mL	143 mm	62 mm	60
CGG012	500 mL	177 mm	77 mm	35
CGG013	1000 mL	216 mm	97 mm	20

* check available caps

DIN18, thread dimensions

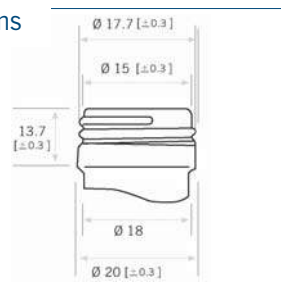

▶ DIN18, transparent



- 1 | Made of soda glass type III
- 2 | Meet European Pharmacopoeia and United States specifications

Code	Cap.	Height	Base Ø	Batch
CGG014	5 ml	50 mm	22 mm	255
CGG015	10 ml	58 mm	25 mm	192
CGG016	15 ml	65 mm	28 mm	100
CGG017	30 ml	79 mm	33 mm	110
CGG018	50 ml	92 mm	37 mm	88
CGG019	100 ml	112 mm	44 mm	70

* check available caps

▶ CGG - Narrow neck, glass

▶ DIN18, amber



- 1 | Made of soda glass type III
- 2 | Meet European Pharmacopoeia and United States specifications

Code	Cap.	Height	Base Ø	Batch
CGG020	5 ml	50 mm	22 mm	255
CGG021	10 ml	58 mm	25 mm	192
CGG022	15 ml	65 mm	28 mm	156
CGG023	30 ml	79 mm	33 mm	110
CGG053	50 ml	92 mm	37 mm	88
CGG054	100 ml	112 mm	44 mm	70

* CHECK AVAILABLE CAPS



▶ DIN18, cobalt blue



- 1 | Made of soda glass type III
- 2 | Meet European Pharmacopoeia and United States specifications

Code	Cap.	Height	Base Ø	Batch
CGG026	5 ml	50 mm	22 mm	255
CGG027	10 ml	58 mm	25 mm	192
CGG028	15 ml	65 mm	28 mm	156
CGG029	30 ml	79 mm	33 mm	110
CGG053	50 ml	92 mm	37 mm	88
CGG054	100 ml	112 mm	44 mm	70

* CHECK AVAILABLE CAPS



▶ DIN18, green



- 1 | Made of soda glass type III
- 2 | Meet European Pharmacopoeia and United States specifications

Code	Cap.	Height	Base Ø	Batch
CGG030	5 ml	50 mm	22 mm	255
CGG031	10 ml	58 mm	25 mm	192
CGG032	15 ml	65 mm	28 mm	156
CGG033	30 ml	79 mm	33 mm	110

* CHECK AVAILABLE CAPS



▶ CGJ - Narrow neck, plastic

▶ Graduated bottles with cap



- 1 | Made of high density polyethylene
- 2 | Neutral colour

Code	Capacity	Graduation	Neck Ø	Height
CGJ033	50 ml	10 mL	18,5 mm	76 mm
CGJ034	100 ml	20 mL	18,5 mm	115 mm
CGJ035	250 ml	25 mL	23 mm	138 mm
CGJ036	500 ml	50 mL	23 mm	165 mm
CGJ037	1000 ml	100 mL	34,5 mm	213 mm
CGJ038	2000 ml	100 mL	34,5 mm	273 mm



▶ **CGJ - Narrow neck, plastic**

▶ **Bottles with cap, PP**



- 1 | Made of polypropylene, non graduated
- 2 | Neutral colour, it can be filled with substances at high temperature
- 3 | Autoclavable at 121°C

Code	Cap.	GL	Neck Ø	Height	Batch
CGJ042	20 ml	GL14	9 mm	57 mm	500
CGJ043	100 ml	GL18	13 mm	102 mm	500
CGJ044	250 ml	GL25	18 mm	138 mm	250
CGJ045	500 ml	GL25	18 mm	169 mm	100
CGJ046	1000 ml	GL28	21 mm	212 mm	50

▶ **Grey bottles, PE**



- 1 | Made of high density polyethylene
- 2 | Dark grey colour
- 3 | Product suitable for contact with food

Code	Capacity	Diameter	Neck Ø	Height
CGJ052	250 ml	60 mm	23 mm	138 mm
CGJ053	500 ml	74 mm	23 mm	165 mm
CGJ054	1000 ml	93 mm	34,5 mm	213 mm
CGJ055	2000 ml	116 mm	34,5 mm	273 mm

▶ **Sealing cap, HDPE**



- 1 | Made of high density polyethylene
- 2 | Neutral colour
- 3 | Product suitable for contact with food

Code	Capacity	Diameter	Neck Ø	Height
CGJ039	250 ml	60 mm	22 mm	136 mm
CGJ040	500 ml	74 mm	22 mm	170 mm
CGJ041	1000 ml	90 mm	22 mm	222 mm

▶ **Standardized neck without cap**



- 1 | Made of high density polyethylene
- 2 | Neutral colour
- 3 | Product suitable for contact with food
- 4 | Depending on the cap, they can be used as simple bottles, wash bottles or dropping bottles (SEE PICTURE)

Code	GL	Capacity	Diameter	Neck Ø	Height
CGJ047	18	50ml	40 mm	13 mm	84 mm
CGJ048	18	100ml	45 mm	13 mm	102 mm
CGJ056	25	250ml	60 mm	18 mm	138 mm
CGJ049	25	500ml	75 mm	18 mm	169 mm
CGJ050	28	1000ml	95 mm	21 mm	212 mm
CGJ051	28	2000ml	120 mm	21 mm	260 mm



▶ CGL - Stoppers for glass bottles



▶ Safety stopper for DIN18 bottles

- 1 | Made of polyethylene
- 2 | Safety stopper with seal, with removable inner dropper

Code	Description
CGL001	Inner dropper, white
CGL002	Inner dropper, yellow



▶ Dropping stopper for DIN18 bottles

- 1 | Polyethylene stopper with seal
- 2 | Silicone teat, glass tube

Code	Description
CGL003	For bottles 5 mL
CGL004	For bottles 10 mL
CGL005	For bottles 15 ml
CGL006	For bottles 30 mL
CGL007	For bottles 50 mL
CGL008	For bottles 100 mL



▶ Safety cap for bottles DIN28

Code	Description
CGL009	White safety screw cap



▶ Screw cap for DIN28 bottles

- 1 | Polypropylene caps with seal, in various colours

Code	Cap colour	Seal colour
CGL010	Black	Black
CGL011	White	Red
CGL012	Blue	White
CGL013	Red	White
CGL014	Green	White
CGL015	Yellow	White



▶ Dropping plastic stopper for DIN28 bottles

- 1 | Made of polypropylene; the tube can be cut to adapt to bottles from 1000 ml to 30 ml
- 2 | With seal

Code	Colour
CGL019	Blue



▶ CGL - Stoppers for glass bottles

▶ Dropping stopper glass tube for DIN28



1 | Polypropylene cap with seal, silicon teat and glass tube

Code	For bottles of
CGL020	30 mL
CGL021	60 mL
CGL022	125 mL

▶ CGN - Stoppers for plastic bottles

▶ Screw caps for bottles



1 | With holes for safety seals
2 | Made of PE

Code	GL	Batch
CGN011	18	50
CGN012	25	50
CGN013	28	50

▶ CHB - Wide neck, glass

▶ Glass bottles, plastic stopper



Code	Glass	Cap.	Base Ø	Height	Batch
CHB001	Transparent	100 ml	54 mm	95 mm	12
CHB005	Amber	100 ml	54 mm	95 mm	12
CHB002	Transparent	250 ml	74 mm	125 mm	6
CHB006	Amber	250 ml	74 mm	125 mm	6
CHB003	Transparent	500 ml	88 mm	165 mm	6
CHB007	Amber	500 ml	88 mm	165 mm	6
CHB004	Transparent	1000 ml	112 mm	200 mm	6
CHB008	Amber	1000 ml	112 mm	200 mm	6

▶ CHG - Narrow neck, glass

▶ Glass bottles, plastic stopper



Code	Glass	Cap.	Base Ø	Height	Batch
CHG001	Transparent	100 ml	54 mm	95 mm	12
CHG005	Amber	100 ml	54 mm	95 mm	12
CHG002	Transparent	250 ml	74 mm	125 mm	6
CHG006	Amber	250 ml	74 mm	125 mm	6
CHG003	Transparent	500 ml	88 mm	165 mm	6
CHG007	Amber	500 ml	88 mm	165 mm	6
CHG004	Transparent	1000 ml	112 mm	200 mm	6
CHG008	Amber	1000 ml	112 mm	200 mm	6

▶ CJC - Dropper, glass



Code	Glass	Capacity	Ø	RIN	Batch
CJC001	Transp.	50mL	41,5 mm	14/15	30
CJC002	Amber	50mL	41,5 mm	14/15	30

* check for more capacities

page
[51]

▶ CKD - Narrow neck

▶ Wash bottle, PE



- 1 | Tube with removable tip
- 2 | Product suitable for contact with food

Code	Capacity	Ø	Height	Batch
CKD006	100 ml	42 mm	218 mm	-
CKD007	250 ml	58 mm	213 mm	10
CKD008	500 ml	70 mm	218 mm	10
CKD009	1000 ml	90 mm	270 mm	-



▶ CKL - Caps

▶ For wash bottles



- 1 | For standardized narrow neck bottles

Code	DIN	Batch
CKL004	18	50
CKL005	25	50
CKL006	28	50



▶ Spout dropping cap



- 1 | For standardized narrow neck bottles

Code	Spout type	GL	Batch
CKL007	Short	18	50
CKL008	Short	25	50
CKL009	Long	18	50
CKL010	Long	25	50
CKL011	Long	28	50



▶ CLD - With tap, plastic

▶ Round aspirator bottle with tap, HDPE



- 1 | Made of high density polyethylene
- 2 | It can be used at temperatures below zero
- 3 | They are provided with a 3/4" tap that assembles to the bottle with a deep 12 mm thread.

Code	Capacity	Int. Ø	Height	Neck Ø
CLD013	5 L	167 mm	355 mm	51 mm
CLD014	10 L	212 mm	430 mm	51 mm
CLD015	25 L	275 mm	580 mm	80 mm
CLD016	50 L	350 mm	715 mm	80 mm



▶ CLD - With tap, plastic

▶ Tap for round storage bottles HDPE



1 | 3/4" BSP thread

Code	CLD017
------	--------

▶ Tank with spigot, HDPE



- 1 | Made of high density polyethylene
- 2 | Product suitable for contact with food
- 3 | It is supplied with spigot

Code	Capacity	Dim. (LxWxH)	Neck Ø
CLD018	10 liters	28x14x34 mm	44 mm
CLD019	20 liters	32x18x45 mm	46 mm

▶ Bottle with spigot adaptable



- 1 | Made of high density polyethylene
- 2 | They can be used at temperatures below zero
- 3 | They are supplied without spigot

Code	Capacity	Int. Ø	Height	Neck Ø
CLD009	5 l	167 mm	355 mm	51 mm
CLD010	10 l	212 mm	430 mm	51 mm
CLD011	25 l	275 mm	580 mm	80 mm
CLD012	50 l	350 mm	715 mm	80 mm

▶ Wide neck carboy bottle



- 1 | Made of high density polyethylene
- 2 | They have a resistant handle for transportation

Code	Capacity	Ø	Height	Neck Ø
CLG009	5 liters	167 mm	350 mm	85 mm
CLG010	10 liters	210 mm	420 mm	100 mm

CLG - Without tap, plastic

Stackable HDPE tank



- 1 | Made of high density polyethylene
- 2 | Neutral colour, product suitable for contact with food
- 3 | They meet the regulations for the transport of dangerous substances: ADR-RID (by land), IMO-IMDG (sea), and IATA-ACOA (air)

Code	Capacity	GL	Dimensions
CLG011	5 liters	51	163x187x236 mm
CLG012	10 liters	51	187x227x320 mm
CLG013	20 liters	51	236x288x380 mm

page
[53]

CMB - Injection

Vials, thread dimensions

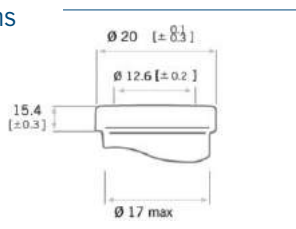

Injection vials



- 1 | Made of soda glass type II, III
- 2 | Meet European Pharmacopoeia and United States specifications

Code	Glass	Capacity	Base Ø	Batch
CMB001	Transparent	7 mL	22 mm	266
CMB002	Transparent	8 mL	23 mm	234
CMB003	Transparent	10 mL	25 mm	192
CMB004	Transparent	15 mL	26.5 mm	165
CMB005	Transparent	20 mL	32 mm	120
CMB006	Transparent	30 mL	36 mm	92
CMB007	Transparent	50 mL	42.5 mm	84
CMB008	Transparent	100 mL	51.6 mm	66
CMB009	Amber	10 mL	25 mm	192
CMB010	Amber	20 mL	32 mm	120
CMB011	Amber	30 mL	36 mm	92
CMB012	Amber	50 mL	42.5 mm	84
CMB013	Amber	100 mL	51.6 mm	66



CMD - Pillboxes

Pillboxes



- 1 | Made of soda glass type II, III
- 2 | Meet European Pharmacopoeia and United States specifications

Code	Glass	Capacity	Neck Ø
CMD001	Amber	18 mL	30 mm



▶ CML - Caps for vials

▶ Caps for injection vials



Code	Description
CML010	Rubber closure for injection vial
CML011	Cap for injection vial

▶ CNB - Evaporating dishes, flat bottom, porcelain



▶ Evaporating dishes low form

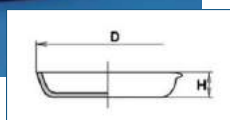

1 | With spout. Glazed inside and outside, except for base

Code	Capacity	Ø	Height	Batch
CNB001	10 ml	50 mm	10 mm	5
CNB002	20 ml	60 mm	14 mm	5
CNB003	28 ml	75 mm	15 mm	5
CNB004	55 ml	80 mm	20 mm	5
CNB005	110 ml	100 mm	25 mm	5
CNB006	250 ml	130 mm	30 mm	5
CNB007	450 ml	160 mm	40 mm	5
CNB008	1100 ml	200 mm	55 mm	-
CNB009	1750 ml	250mm	55 mm	-

▶ Evaporating dishes flat bottom

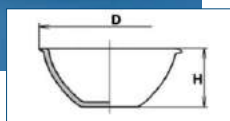

1 | With spout. Glazed inside and outside, except for base

Code	Capacity	Ø	Height	Batch
CNB010	22 mL	54 mm	22 mm	5
CNB011	62 mL	70 mm	30 mm	5
CNB012	93 mL	86 mm	33 mm	5
CNB013	154 mL	98 mm	40 mm	5
CNB014	265 mL	112 mm	50 mm	5
CNB015	330 mL	126 mm	53 mm	5
CNB016	450 mL	145 mm	55 mm	5
CNB017	620 mL	151 mm	63 mm	5
CNB018	800 mL	169 mm	68 mm	-
CNB019	1000 mL	195 mm	74 mm	-
CNB020	25000 mL	254 mm	105 mm	-

▶ CNG - Evaporating dishes, round bottom, porcelain

▶ Evaporating dishes round bottom



Code	Capacity	Diameter	Height	Batch
CNG001	15 mL	47 mm	20 mm	40
CNG002	35 mL	60 mm	25 mm	20
CNG003	50 mL	70 mm	28 mm	10
CNG004	60 mL	74 mm	30 mm	10
CNG005	75 mL	82 mm	32 mm	10
CNG006	100 mL	90 mm	35 mm	10
CNG007	125 mL	98 mm	38 mm	10
CNG008	140 mL	100 mm	39 mm	10
CNG009	150 mL	104 mm	40 mm	10
CNG010	200 mL	110 mm	44 mm	10
CNG011	270 mL	120 mm	49 mm	10
CNG012	300 mL	126 mm	52 mm	10
CNG013	400 mL	150 mm	58 mm	6
CNG014	1000 mL	206 mm	64 mm	3

▶ CNG - Evaporating dishes, round bottom, porcelain

▶ Evaporating dishes round bottom



1| With spout. Glazed inside and outside except for base

Code	Capacity	Diameter	Height	Batch
CNG015	10 mL	40 mm	16 mm	5
CNG016	20 mL	50 mm	20 mm	5
CNG017	30 mL	63 mm	25 mm	5
CNG018	60 mL	80 mm	32 mm	5
CNG019	107 mL	81 mm	38 mm	5
CNG020	140 mL	94 mm	42 mm	5
CNG021	150 mL	100 mm	40 mm	5
CNG022	232 mL	112 mm	47 mm	5
CNG023	285 mL	125 mm	50 mm	5
CNG024	300 mL	132 mm	55 mm	5
CNG025	400 mL	138 mm	61 mm	5
CNG026	580 mL	160 mm	64 mm	5
CNG027	700 mL	170 mm	74 mm	-
CNG028	1300 mL	202 mm	86 mm	-
CNG029	6000 mL	320 mm	140 mm	-



page
[55]

▶ Evaporating dishes round bottom



1| With spout. Glazed inside and outside except for base

Code	Capacity	Diameter	Height	Batch
CNG030	41 mL	72 mm	26 mm	5
CNG031	62 mL	83 mm	27 mm	5
CNG032	110 mL	96 mm	30 mm	5
CNG033	160 mL	110 mm	37 mm	5
CNG034	215 mL	117 mm	41 mm	5
CNG035	240 mL	127 mm	42 mm	5
CNG036	325 mL	142 mm	46 mm	5
CNG037	420 mL	154 mm	50 mm	5
CNG038	558 mL	170 mm	55 mm	5



▶ CNK - Casseroles, porcelain

▶ Flat bottom



1| With spout. Glazed inside and outside except for rim

Code	Capacity	Ext. Ø	Height	Batch
CNK001	30 mL	50 mm	30 mm	-
CNK002	70 mL	66 mm	39 mm	20
CNK003	150 mL	90 mm	48 mm	10
CNK004	200 mL	96 mm	52 mm	-
CNK005	250 mL	108 mm	60 mm	-
CNK006	500 mL	132 mm	70 mm	-



▶ Flat bottom



1| With spout. Glazed inside and outside except for rim

Code	Capacity	Ext. Ø	Height	Batch
CNK007	22 mL	45 mm	26 mm	2
CNK008	84 mL	67 mm	39 mm	-
CNK009	176 mL	85 mm	49 mm	-
CNK010	270 mL	101 mm	51 mm	-
CNK011	450 mL	120 mm	64 mm	-
CNK012	960 mL	150 mm	86 mm	-

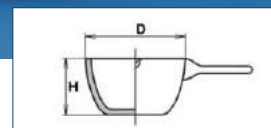

▶ CNK - Casseroles, porcelain

▶ With wood handle

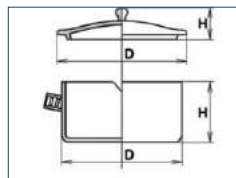

- 1 | With spout and lid
- 2 | Glazed inside and outside except for base

Code	Capacity	Ext. Ø	Height	Batch
CNK013	125 ml	75 mm	40 mm	8
CNK014	200 ml	85 mm	45 mm	8

▶ CNL - Crystallizing dishes with spout

▶ Crystallizing dishes with spout

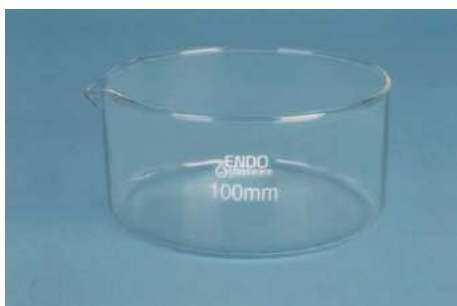

- 1 | Made of borosilicate glass, with spout

Code	Diameter	Capacity	Height	Batch
CNL001	50 mm	40 mL	30 mm	-
CNL002	60 mm	60 mL	35 mm	-
CNL003	70 mm	100 mL	40 mm	-
CNL004	80 mm	150 mL	45 mm	-
CNL005	100 mm	250 mL	50 mm	6
CNL006	120 mm	500 mL	65 mm	-
CNL007	150 mm	1000 mL	75 mm	-
CNL008	180 mm	1500 mL	90 mm	-
CNL009	230 mm	3500 mL	100 mm	-

▶ CNN - Crystallizing dishes without spout, glass

▶ With rim



- 1 | Made of thick pressed glass

Code	Diameter	Capacity	Height	Batch
CNN001	80 mm	150 mL	40 mm	12
CNN002	100 mm	300 mL	55 mm	20
CNN003	120 mm	500 mL	60 mm	10
CNN004	150 mm	1000 mL	70 mm	6
CNN005	190 mm	1500 mL	90 mm	12

▶ CPB - Crucibles, tall form, porcelain

▶ Crucibles with lid



1 | With lid. Glazed inside and outside except for rim and base

Code	Capacity	Diameter	Height	Batch
CPB001	15 mL	32 mm	34 mm	10
CPB002	18 mL	34 mm	36 mm	10
CPB004	20 mL	36 mm	38 mm	10
CPB005	25 mL	38 mm	40 mm	10
CPB006	30 mL	40 mm	46 mm	10
CPB007	40 mL	42 mm	54 mm	10
CPB008	50 mL	43 mm	58 mm	10
CPB009	100 mL	70 mm	76 mm	-



page
[57]

▶ Crucible without lid



1 | Without lid. Glazed inside and outside except for rim and base

Code	Diameter	Height	Capacity	Batch
CPB010	30 mm	38 mm	15 mL	5
CPB011	35 mm	44 mm	26 mL	5
CPB012	40 mm	50 mm	35 mL	5
CPB013	45 mm	56 mm	50 mL	5
CPB014	50 mm	62 mm	72 mL	5
CPB015	60 mm	75 mm	120 mL	5



▶ CPC - Crucibles, medium form, porcelain

▶ Crucible with lid



1 | With lid. Glazed inside and outside except for rim and base

Code	Capacity	Diameter	height	Batch
CPC001	5 mL	25 mm	21 mm	-
CPC002	10 mL	30 mm	28 mm	10
CPC003	15 mL	35 mm	30 mm	10
CPC004	25 mL	40 mm	36 mm	10
CPC005	30 mL	42 mm	41 mm	10
CPC006	40 mL	48 mm	42 mm	10
CPC007	50 mL	53 mm	46 mm	10
CPC008	70 mL	56 mm	56 mm	10
CPC009	100 mL	63 mm	59 mm	10
CPC010	300 mL	90 mm	78 mm	10



▶ Crucible without lid



1 | Without lid, glazed inside and outside except for rim and base.

Code	Diameter	Height	Capacity	Batch
CPC011	30 mm	25 mm	10 ml	5
CPC012	35 mm	28 mm	12 ml	5
CPC013	40 mm	32 mm	20 ml	5
CPC014	45 mm	36 mm	30 ml	5
CPC015	50 mm	40 mm	45 ml	5
CPC016	60 mm	48 mm	80 ml	5
CPC017	70 mm	56 mm	120 ml	5



▶ CPD - Crucibles, low form, porcelain

▶ Crucible with lid



Nahita

1 | With lid. Glazed inside and outside except for rim and base

Code	Capacity	Diameter	Height	Batch
CPD001	15 mL	43 mm	23 mm	10
CPD002	25 mL	47 mm	227 mm	10
CPD003	30 mL	51 mm	230 mm	10
CPD004	50 mL	59 mm	238 mm	10

▶ Crucible without lid



JIP

1 | Without lid, glazed inside and outside except for rim and base

Code	Cap.	Diam.	Height	Batch
CPD005	5 mL	30 mm	19 mm	5
CPD006	10 mL	35 mm	22 mm	5
CPD007	17 mL	40 mm	25 mm	5
CPD008	21 mL	45 mm	28 mm	5
CPD009	34 mL	50 mm	32 mm	5
CPD010	62 mL	60 mm	38 mm	5
CPD011	91 mL	70 mm	44 mm	5

▶ Crucibles for high frequency furnace

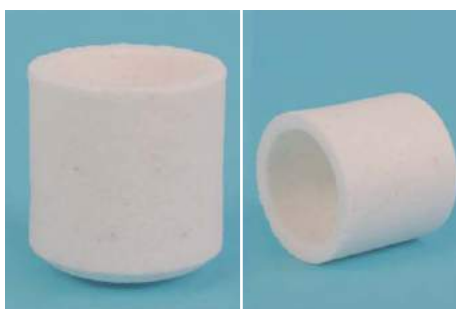

Nahita

1 | Non glazed
2 | Temperatures up to 1350°C

Code	Int. Ø	Height	Diameter	Batch
CPD012	19 mm	26 mm	25 mm	10

▶ CPF - Lids for crucibles, porcelain

▶ Crucible shelf

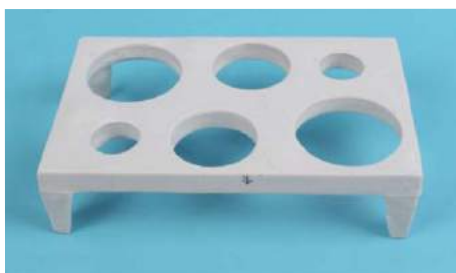

Nahita

1 | Non glazed
2 | With 6 holes of different diameter:
- 2 of 50 mm
- 2 of 40 mm
- 2 of 25 mm

Code	Length	Width	Height
CPF012	160 mm	100 mm	40 mm

▶ CPF - Lids for crucibles, porcelain

▶ Beehive shelves for combustion crucibles



1 | Glazed except for rim

Code	Diameter
CPF001	75 mm
CPF002	100 mm



▶ Porcelain saucer glazed



Code	Dimensions
CPF011	115/125 mm

▶ Lid for combustion crucible



1 | Glazed inside and outside

Code	D1	D2	Batch
CPF003	30 mm	34 mm	5
CPF004	35 mm	39 mm	5
CPF005	40 mm	44 mm	5
CPF006	45 mm	49 mm	5
CPF007	50 mm	54 mm	5
CPF008	60 mm	64 mm	5
CPF009	70 mm	74 mm	5
CPF010	80 mm	84 mm	5

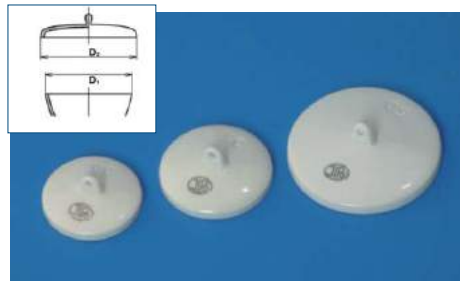

▶ CPK - Annealing dishes

▶ Tall form, without spout



1 | Glazed inside and outside except for rim and base

Code	Diameter	Height	Capacity	Batch
CPK001	30 mm	15 mm	8 ml	5
CPK002	40 mm	20 mm	21 ml	5
CPK003	50 mm	25 mm	35 ml	5
CPK004	60 mm	30 mm	64 ml	5
CPK005	70 mm	35 mm	103 ml	5



▶ Low form, without spout



1 | Glazed inside and outside except for rim and base

Code	Diameter	Height	Capacity	Batch
CPK006	38 mm	10 mm	7 ml	5
CPK007	44 mm	11 mm	9 ml	5
CPK008	47 mm	13 mm	12 ml	5
CPK009	81 mm	20 mm	70 ml	5
CPK010	122mm	28 mm	220ml	5



▶ Tall form, with spout



1 | Glazed inside and outside except for rim and base

Code	Diameter	Height	Capacity	Batch
CPK011	30 mm	15 mm	8 ml	5
CPK012	40 mm	20 mm	21ml	5
CPK013	50 mm	25 mm	35 ml	5
CPK014	60 mm	30 mm	64 ml	5
CPK015	70 mm	35 mm	103 ml	5



▶ CPL - Ignition dishes

▶ Ignition dishes



Nahita

1 | Glazed except for base and rim

Code	Length	Width	Height	Batch
CPL001	50 mm	28 mm	15 mm	-
CPL002	75 mm	35 mm	15 mm	10
CPL003	80 mm	50 mm	18 mm	10
CPL004	120 mm	65 mm	18 mm	10

▶ Ignition dishes



JIP

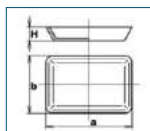

1 | Glazed inside and outside except for rim and base

Code	a	b	h	Cap.	Batch
CPL005	50 mm	35 mm	12 mm	6 ml	5
CPL006	60 mm	40 mm	12 mm	13 ml	5
CPL007	74 mm	49 mm	14 mm	28 ml	5
CPL008	95 mm	65 mm	14 mm	40 ml	5

▶ CPN - Combustion boats

▶ Combustion boats



Nahita

1 | Non glazed
2 | It stands temperatures up to 1350°C

Code	Longitud	Height	Width	Batch
CPN001	88 mm	10 mm	13 mm	100

▶ Combustion boats

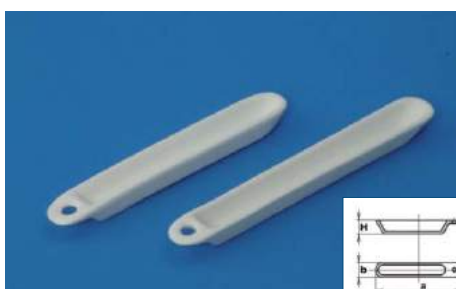

JIP

1 | Non glazed
2 | It stands temperatures up to 1350°C

Code	a	b	h	Batch
CPN002	75 mm	13 mm	8 mm	50
CPN003	105 mm	14 mm	9 mm	50
CPN004	85 mm	13 mm	8 mm	50
CPN005	90 mm	13 mm	8 mm	50



[D] INDEX OF CONTENTS VOLUMETRY

[DB] Measuring cylinders	62
DBB - Class A, tall form, glass	62
DBG - Class B, tall form, glass	63
DBJ - Class B, tall form, plastic	63
[DD] Volumetric flasks	64
DDB - Class A with stopper, glass	64
DDW - 2 marks, glass	65
[DG] Graduated pipettes	65
DGB - Class A with bulb, glass	65
DGD - Class A without bulb, glass	66
DGG - Class B with bulb, glass	66
DGJ - Class B without bulb, glass	66
[DJ] Volumetric pipettes	66
DJB - 1 mark, class A, with bulb	66
DJD - 1 mark, class A, without bulb	67
DJG - 1 mark, class B, with bulb	67
DJJ - 1 mark, class B, without bulb	67
DJP - 2 marks, class A, with bulb	67
DJR - 2 marks, class B, with bulb	68
[DL] Pipettes, others	68
DLB - Pasteur pipettes	68
DLD - Wine pipettes	68
[DN] Burettes	69
DNB - Type Mohr, PTFE stopcock	69
DND - Type Mohr, glass stopcock	69
DNM - Pellet type	70

TRADEMARKS:



▶ DBB - Class A, tall form, glass

▶ Tall form, with spout



- 1 | Blue graduation and hexagonal base
- 2 | DIN EN ISO 4788

Code	Cap.	ØxH	Grad.	Tolerance
DBB001	5 ml	11x112 mm	0.1 mL	± 0.05 mL
DBB002	10 ml	12x135 mm	0.2 mL	± 0.1 mL
DBB003	25 ml	20x160 mm	0.5 mL	± 0.25 mL
DBB004	50 ml	25x195 mm	1.0 mL	± 0.5 mL
DBB005	100 ml	30x240 mm	1.0 mL	± 0.5 mL
DBB006	250 ml	40x320 mm	2.0 mL	± 1.0 mL
DBB007	500 ml	50x380 mm	5.0 mL	± 2.5 mL
DBB008	1000 ml	65x420 mm	10.0 mL	± 5.0 mL
DBB009	2000 ml	80x520 mm	20.0 mL	± 10.0 mL

▶ Tall form, with spout



- 1 | Blue graduation and hexagonal base
- 2 | DIN EN ISO 4788

Code	Cap.	Grad.	Tolerance	ØxH (mm)	Batch
DBB027	5 ml	0.1 mL	±0,05	12.9x115	10
DBB028	10 ml	0.2 mL	±0.10	15.5x135	10
DBB029	25 ml	0.5 mL	±0.25	21.3x160	10
DBB030	50 ml	1.0 mL	±0.50	26x195	10
DBB031	100 ml	1.0 mL	±0.50	31.3x240	-
DBB032	250 ml	2.0 mL	±1.00	40.7x320	-
DBB033	500 ml	5.0 mL	±2.50	53.2x380	-
DBB034	1000 ml	10.0 mL	±5.00	67x465	-
DBB035	2000 ml	20.0 mL	±10.00	85x535	-

▶ With stopper, plastic



- 1 | Blue graduation and hexagonal base
- 2 | DIN EN ISO 4788

Code	Cap.	Height	Grad.	Tolerance	Ground
DBB018	5 ml	112 mm	0.1 mL	± 0.1 mL	10/19
DBB019	10 ml	135 mm	0.2 mL	± 0.2 mL	10/19
DBB020	25 ml	160 mm	0.5 mL	± 0.5 mL	19/26
DBB021	50 ml	195 mm	1.0 mL	± 1.0 mL	19/26
DBB022	100 ml	240 mm	1.0 mL	± 1.0 mL	29/32
DBB023	250 ml	320 mm	2.0 mL	± 2.0 mL	29/32
DBB024	500 ml	380 mm	5.0 mL	± 5.0 mL	34/35
DBB025	1000 ml	420 mm	10.0 mL	± 10.0 mL	45/40
DBB026	2000 ml	520 mm	20.0 mL	± 20.0 mL	45/40

▶ With plastic stopper



- 1 | Blue graduation and hexagonal base
- 2 | DIN EN ISO 4788

Code	Capacity	Division	Tolerance	Ground	Batch
DBB045	5 ml	0.1 mL	± 0.05 mL	10/19	10
DBB046	10 ml	0.2 mL	± 0.10 mL	10/19	10
DBB047	25 ml	0.5 mL	± 0.25 mL	14/23	10
DBB048	50 ml	1.0 mL	± 0.50 mL	19/26	10
DBB049	100 ml	1.0 mL	± 0.50 mL	24/29	10
DBB050	250 ml	2.0 mL	± 1.0 mL	29/32	10
DBB051	500 ml	5.0 mL	± 2.50 mL	34/35	10
DBB052	1000 ml	10.0 mL	± 5.0 mL	45/40	4
DBB053	2000 ml	20.0 mL	± 10.0 mL	45/40	3

▶ DBB - Class A, tall form, glass

▶ With glass stopper



- 1| Blue graduation and hexagonal base
- 2| DIN EN ISO 4788

Code	Capacity	Division	Tolerance	Ground	Batch
DBB036	5 ml	0.1 mL	± 0.05 mL	10/19	10
DBB037	10 ml	0.2 mL	± 0.10 mL	10/19	10
DBB038	25 ml	0.5 mL	± 0.25 mL	14/23	10
DBB039	50 ml	1.0 mL	± 0.50 mL	19/26	10
DBB040	100 ml	1.0 mL	± 0.50 mL	24/29	10
DBB041	250 ml	2.0 mL	± 1.0 mL	29/32	10
DBB042	500 ml	5.0 mL	± 2.50 mL	34/35	10
DBB043	1000 ml	10.0 mL	± 5.0 mL	45/40	4
DBB044	2000 ml	20.0 mL	± 10.0 mL	45/40	-



▶ DBG - Class B, tall form, glass

▶ Tall form, with spout



- 1| White graduation and hexagonal base
- 2| DIN EN ISO 4788

Code	Capacity	Diameter	Height	Graduation	Tolerance
DBG001	5 ml	11 mm	112 mm	0.1 mL	±0.1 mL
DBG002	10 ml	12 mm	135 mm	0.2 mL	±0.2 mL
DBG003	25 ml	20 mm	160 mm	0.5 mL	±0.5 mL
DBG004	50 ml	25 mm	195 mm	1.0 mL	±1.0 mL
DBG005	100 ml	30 mm	240 mm	1.0 mL	±1.0 mL
DBG006	250 ml	40 mm	320 mm	2.0 mL	±2.0 mL
DBG007	500 ml	50 mm	380 mm	5.0 mL	±5.0 mL
DBG008	1000 ml	65 mm	420 mm	10.0 mL	±10.0 mL
DBG009	2000 ml	80 mm	520 mm	20.0 mL	±20.0 mL



▶ With stopper, plastic



- 1| White graduation and hexagonal base. DIN EN ISO 4788

Code	Cap.	Height	Grad.	Tolerance	Ground
DBG010	5 ml	112 mm	0.1 mL	±0.1 mL	10/19
DBG011	10 ml	135 mm	0.2 mL	±0.2 mL	10/19
DBG012	25 ml	160 mm	0.5 mL	±0.5 mL	19/26
DBG013	50 ml	195 mm	1.0 mL	±1.0 mL	19/26
DBG014	100 ml	240 mm	1.0 mL	±1.0 mL	29/32
DBG015	250 ml	320 mm	2.0 mL	±2.0 mL	29/32
DBG016	500 ml	380 mm	5.0 mL	±5.0 mL	34/35
DBG017	1000 ml	420 mm	10.0 mL	±10.0 mL	45/40
DBG018	2000 ml	520 mm	20.0 mL	±20.0 mL	45/40



▶ DBJ - Class B, tall form, plastic

▶ With spout, PP, moulded graduation



- 1| Made of polypropylene, hexagonal base. Permanent moulded graduation

Code	Capacity	Graduation	Subdiv.	Batch
DBJ001	10 mL	1 mL	0.2 mL	10
DBJ002	25 mL	5 mL	0.5 mL	10
DBJ003	50 mL	10 mL	1.0 mL	10
DBJ004	100 mL	10 mL	1.0 mL	10
DBJ005	250 mL	20 mL	2.0 mL	6
DBJ006	500 mL	50 mL	5.0 mL	6
DBJ007	1000 mL	100 mL	10 mL	4
DBJ008	2000 mL	200 mL	20 mL	2



▶ DDB - Class A, with stopper, glass

▶ Transparent glass, with PP stopper



- 1 | With batch certificate, white graduation
- 2 | According to ISO 1042

Code	Capacity	Base Ø	Height (±5)	Tolerance	Batch
DDB001	5 mL	15 mm	80 mm	0.025 mL	20
DDB002	10 mL	18 mm	90 mm	0.025 mL	10
DDB003	25 mL	25 mm	110 mm	0.040 mL	2
DDB004	50 mL	30 mm	140 mm	0.060 mL	2
DDB005	100 mL	40 mm	170 mm	0.100 mL	2
DDB006	200 mL				2
DDB007	250 mL	50 mm	220 mm	0.150 mL	2
DDB008	500 mL	70 mm	260 mm	0.250 mL	2
DDB009	1000 mL	85 mm	300 mm	0.400 mL	2
DDB010	2000 mL	100 mm	370 mm	0.600 mL	-

▶ Amber glass, with PP stopper



- 1 | With batch certificate, white graduation
- 2 | According to ISO 1042

Code	Capacity	Base Ø	Height (±5)	Tolerance	Batch
DDB011	5 ml	15 mm	80 mm	0.025 mL	20
DDB012	10 ml	18 mm	90 mm	0.025 mL	10
DDB013	25 ml	25 mm	110 mm	0.040 mL	10
DDB014	50 ml	30 mm	140 mm	0.060 mL	2
DDB015	100 ml	40 mm	170 mm	0.100 mL	2
DDB016	250 ml	50 mm	220 mm	0.150 mL	2

▶ Transparent glass, with PP stopper



- 1 | With individual calibration certificate
- 2 | According to ISO 1042
- 3 | Blue graduation

Code	Capacity	Ground	Tolerance
DDB017	25 mL	10/19	0.040 mL
DDB018	50 mL	12/21	0.060 mL
DDB019	100 mL	14/23	0.100 mL
DDB020	200 mL	14/23	0.150 mL
DDB021	250 mL	14/23	0.150 mL
DDB022	500 mL	19/26	0.250 mL
DDB023	1000 mL	24/29	0.400 mL
DDB024	2000 mL	29/32	0.600 mL

* consult for other capacities

▶ Transparent glass, with PP stopper



- 1 | With individual calibration certificate, blue graduation
- 2 | According to ISO 1042

Code	Capacity	Ground	Tolerance
DDB025	5 mL	10/19	0.040 mL
DDB026	10 mL	10/19	0.040 mL
DDB027	20 mL	10/19	0.040 mL
DDB028	25 mL	10/19	0.040 mL
DDB029	50 mL	12/21	0.060 mL
DDB030	100 mL	14/23	0.100 mL
DDB031	200 mL	14/23	0.150 mL
DDB032	250 mL	14/23	0.150 mL
DDB033	500 mL	19/26	0.250 mL
DDB034	1000 mL	24/29	0.400 mL
DDB035	2000 mL	29/32	0.600 mL

▶ DDB - Class A, with stopper, glass

▶ Amber glass, with PP stopper



- 1 | With individual calibration certificate, white graduation
- 2 | According to ISO 1042

Code	Cap.	Ground	Tolerance	Batch
DDB036	5mL	10/19	0.040 mL	2
DDB037	10mL	10/19	0.040 mL	2
DDB038	20mL	10/19	0.040 mL	2
DDB039	25mL	10/19	0.040 mL	2
DDB040	50mL	12/21	0.060 mL	2
DDB041	100mL	14/23	0.100 mL	2
DDB042	200mL	14/23	0.150 mL	2
DDB043	250mL	14/23	0.150 mL	2
DDB044	500mL	19/26	0.250 mL	2
DDB045	1000mL	24/29	0.400 mL	2
DDB046	2000mL	29/32	0.600 mL	2

page
[65]

▶ DDW - Two marks, glass

▶ Flask two marks, glass



Code	Capacity
DDW001	100/110 mL
DDW002	200/220 mL



▶ DGB - Class A with bulb, glass

▶ 0 bottom

- 1 | ISO835. Blue graduation

Code	Capacity	Graduation	Colour
DGB001	1 mL	0.10 mL	Red
DGB009	1 mL	0.01 mL	Yellow
DGB002	2 mL	0.10 mL	Green
DGB020	2 mL	0.01 mL	Yellow
DGB008	5 mL	0.05 mL	Red
DGB003	5 mL	0.10 mL	Blue
DGB004	10 mL	0.10 mL	Orange
DGB005	20 mL	0.10 mL	Yellow
DGB006	25 mL	0.10 mL	White
DGB007	50 mL	0.10 mL	Black



▶ 0 top

- 1 | ISO835. Blue graduation

Code	Capacity	Graduation	Colour
DGB010	1mL	0.10 mL	Yellow
DGB018	1mL	0.01 mL	Red
DGB019	2mL	0.01 mL	Yellow
DGB011	2mL	0.10 mL	Green
DGB017	5mL	0.05 mL	Red
DGB012	5mL	0.10 mL	Blue
DGB013	10mL	0.10 mL	Orange
DGB014	20mL	0.10 mL	Yellow
DGB015	25mL	0.10 mL	White
DGB016	50mL	0.10 mL	Black



▶ DGD - Class A without bulb, glass

▶ 0 top



1 | With batch certificate, amber graduation. ISO 835

Code	Capacity	Graduation	Batch
DGD001	1 mL	0.01 mL	10
DGD002	2 mL	0.02 mL	10
DGD003	5 mL	0.05 mL	10
DGD005	10 mL	0.10 mL	10

▶ DGG - Class A with bulb, glass

▶ 0 bottom



1 | Amber graduation. ISO 835

Code	Capacity	Graduation
DGG011	1 mL	0.01 mL
DGG008	1 mL	0.05 mL
DGG001	1 mL	0.10 mL
DGG012	2 mL	0.02 mL
DGG009	2 mL	0.05 mL
DGG002	2 mL	0.10 mL
DGG010	5 mL	0.05 mL
DGG003	5 mL	0.10 mL
DGG004	10 mL	0.10 mL
DGG005	20 mL	0.10 mL
DGG006	25 mL	0.10 mL
DGG007	50 mL	0.10 mL

▶ DGJ - Class B without bulb, glass

▶ 0 bottom



1 | Amber graduation. ISO 835

Code	Capacity	Graduation	Batch
DGJ001	0,1 mL	0.001 mL	10
DGJ002	0.2 ml	0.002 mL	10
DGJ003	0.5 ml	0.005 mL	10
DGJ004	0.5 mL	0.01 mL	-
DGJ005	1 ml	0.01 ml	10
DGJ006	2 ml	0.02 ml	10
DGJ007	5 ml	0.05 ml	10
DGJ008	10 ml	0.1 ml	10
DGJ009	20 ml	0.1 ml	10
DGJ010	25 m	0.1 ml	10

▶ DJB - 1 mark, class A, with bulb



1 | Calibrated at 20 °C with colour code. ISO 648

Code	Capacity	Tolerance
DJB001	1 mL	±0.007 mL
DJB002	2 mL	+0.010 mL
DJB003	5 mL	±0.015 mL
DJB004	10 mL	±0.020 mL
DJB005	15 mL	±0.030 mL
DJB006	20 mL	±0.030 mL
DJB007	25 mL	±0.030 mL
DJB008	50 ml	±0.050 mL
DJB009	100 mL	±0.080 mL

▶ DJD - 1 mark, class A, without bulb



1 | Calibrated at 20°C with colour code. ISO 648

Code	Capacity	Tolerance	Batch
DJD001	1 ml	±0.007 mL	25
DJD002	2 ml	±0.010 mL	5
DJD003	5 ml	±0.015 mL	10
DJD004	10 ml	±0.020 mL	5
DJD005	20 ml	±0.030 mL	5
DJD006	25 ml	±0.030 mL	5



page
[67]

▶ DJG - 1 mark, class B, with bulb



1 | Calibrated at 20°C with colour code. ISO 648

Code	Capacity	Length	Color
DJG001	1 mL	310 mm	Blue
DJG002	2 mL	330 mm	Orange
DJG003	5 mL	400 mm	White
DJG004	10 mL	440 mm	Red
DJG005	15 mL	455 mm	Green
DJG006	20 mL	500 mm	Yellow
DJG007	25 mL	520 mm	Blue
DJG008	50 mL	540 mm	Red
DJG009	100 mL	585 mm	Yellow



▶ DJJ - 1 mark, class B, without bulb



1 | Calibrated at 20°C with colour code. ISO 648

Code	Capacity	Tolerance	Batch
DJJ001	1 ml	±0.015 mL	5
DJJ002	2 ml	±0.020 mL	5
DJJ003	5 ml	±0.030 mL	10
DJJ004	10 ml	±0.040 mL	10
DJJ005	11 ml	±0.040 mL	10
DJJ006	20 ml	±0.060 mL	10
DJJ007	25 ml	±0.060 mL	5



▶ DJP - 2 marks, class A, with bulb



1 | Calibrated at 20°C with colour code. ISO 648

Code	Capacity	Tolerance
DJP001	1 mL	±0.007 mL
DJP002	2 mL	±0.010 mL
DJP003	5 mL	±0.015 mL
DJP004	10 mL	±0.020 mL
DJP005	15 mL	±0.030 mL
DJP006	20 mL	±0.030 mL
DJP007	25 mL	±0.030 mL
DJP008	50 mL	±0.050 mL
DJP009	100 mL	±0.080 mL



▶ DJR - 2 marks, class A, with bulb



1 | Calibrated at 20°C with colour code. ISO 648

Code	Capacity	Length	Colour
DJR001	1 mL	310 mm	Blue
DJR002	2 mL	330 mm	Orange
DJR003	5 mL	400 mm	White
DJR004	10 mL	440 mm	Red
DJR005	20 mL	515 mm	Yellow
DJR006	25 mL	520 mm	Blue
DJR007	50 mL	540 mm	Red
DJR008	100 mL	585 mm	Yellow

▶ DLB - Pasteur pipettes

▶ Glass Pasteur pipettes



- 1 | With constriction on the upper suction end, long and thin tip
- 2 | Non sterile and non graduated. Box of 250 units

Code	Length	Batch
DLB001	50 mm	8
DLB002	230 mm	8

▶ Plastic Pasteur pipettes



- 1 | Made of polyethylene for single use, non sterile. Bags of 500 units

Code	Length	Cap.	Description	Batch
DLB010	160 mm	1.0 mL	Graduated	10
DLB011	160 mm	3 mL	Graduated	-
DLB012*	115 mm	0.4 mL	Non graduated	-

* Capillary tip

▶ DLD - Pipettes for wine

▶ Glass pipette for wine



- 1 | In glass with two handles

Code	Capacity	Diameter	Length
DLD001	350 mL mm	30 mm	640 mm

▶ DNB - Mohr type, PTFE stopcock

▶ PTFE stopcock, class A



1 | Blue graduation. ISO 835

Code	Capacity	Length	Graduation	Tolerance
DNB010	10 ml	600 mm	0.1 mL	± 0.03 mL
DNB011	25 ml	630 mm	0.1 mL	± 0.05 mL
DNB012	50 ml	860 mm	0.1 mL	± 0.05 mL

▶ PTFE stopcock, class B



1 | Blue graduation

Code	Capacity	Length	Graduation	Tolerance
DNB007	10 ml	600 mm	0.1 mL	± 0.05 mL
DNB008	25 ml	630 mm	0.1 mL	± 0.10 mL
DNB009	50 ml	860 mm	0.1 mL	± 0.10 mL

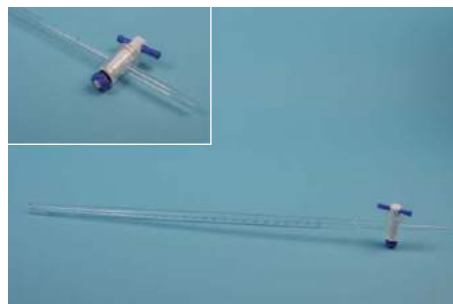

▶ PTFE stopcock



- 1 | Transparent methacrylate (PMMA), white graduation
- 2 | Detachable, straight mouth

Code	Cap.	Length	Grad.	Res.	Batch
DNB015	25 ml	560 mm	1 mL	0.1 mL	10
DNB016	50 ml	735 mm	1 mL	0.1 mL	10

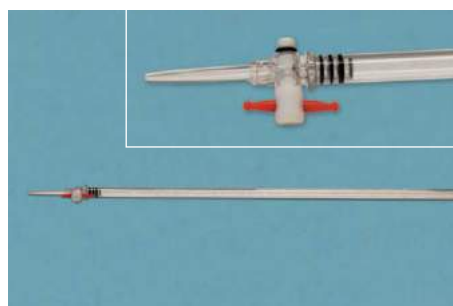

▶ DND - Mohr type, glass stopcock

▶ Glass stopcock, class A



1 | Blue graduation, ISO 835

Code	Capacity	Length	Graduation	Tolerance
DND005	10 ml	535 mm	0.1 ml	± 0.03 ml
DND006	25 ml	565 mm	0.1 ml	± 0.05 ml
DND007	50 ml	780 mm	0.1 ml	± 0.05 ml

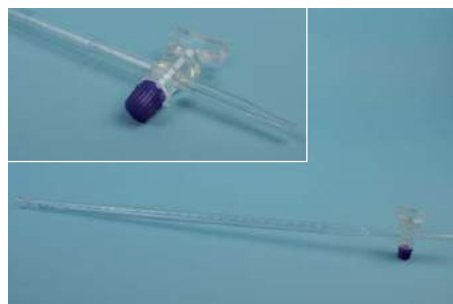

DND - Mohr type, glass stopcock

▶ Glass stopcock, class B



1 | Blue graduation, ISO 835

Code	Capacity	Length	Graduation	Tolerance
DND002	10 ml	535 mm	0.1 mL	± 0.05 mL
DND003	25 ml.	565 mm	0.1 mL	± 0.10 mL
DND004	50 ml	780 mm	0.1 mL	± 0.10 mL

DNM - Pellet type

▶ Glass PTFE stopcock



1 | Class AS, blue graduation. With Schellbach band for easy reading
2 | PTFE lateral stopcock and glass intermediate stopcock

Code	Capacity	Graduation
DNM001	10 mL	1/10
DNM002	10 mL	1/20
DNM003	10 mL	1/50
DNM004	25 mL	1/20
DNM005	25 mL	1/10
DNM006	50 mL	1/10
DNM007	100 mL	1/5

▶ Glass PTFE stopcock, amber glass



1 | Class AS, white graduation. With Schellbach band for easy reading
2 | PTFE lateral stopcock and glass intermediate stopcock

Code	Capacity	Graduation
DNM008	10 mL	1/10
DNM009	10 mL	1/20
DNM010	10 mL	1/50
DNM011	25 mL	1/20
DNM012	25 mL	1/10
DNM013	50 mL	1/10
DNM014	100 mL	1/5



[F] INDEX OF CONTENTS LABORATORY ASSEMBLIES AND TOOLS

[FC] Assemblies 72	[FK] Spatule/Spoons 82
FCB - Stands72	FKB - Spoon-spatula82
FCD - Laboratory jacks72	FKD - Spoon-spatula, micro84
FCG - Clamps f/burettes, tubes73	FKG - Spatula84
FCJ - Clamps, 3-4 prongs74	FKL - Double spatula85
FCK - Clamps, special74	FKN - Double spatula, micro85
FCM - Clips f/ground joints75	FKP - Spoons85
FCP - Bossheads76	FKR - Double spoons86
FCR - Rings, open77	FKW - Scoops86
FCV - Rings, closed78	[FM] Dissection material 87
FCY - Rods without thread78	FMB - Scalpels/blades87
[FF] Heating 78	FMD - Dissecting needles88
FFB - Tripod stands78	FMG - Forceps, curved89
FFD - Gauze iron wires79	FMJ - Forceps, straight90
FFG - Triangles79	FML - Forceps, special90
FFJ - Burners79	FMN - Scissors92
FFL - Tongs f/crucibles, capsules80	FMQ - Dissecting kits94
FFN - Tongs f/beakers, tubes81	[FZ] Others 95
[FH] Tubing and accessories 81	FZB - Stabilizing rings95
FHD - Clamps81	FZD - Glass markers95
FHN - Tubing f/laboratory81	FZG - Compass95

TRADEMARKS:



▶ FCB - Stands

▶ A-shaped support stands



- 1| Base in furnace painted cast steel, rod in chromium plated steel
- 2| Rubber caps in the base for good stability

Code	Base	Rod (LxØ)
FCB001	200x30 mm	600x10 mm

▶ Retort stands



Code	Colour	Base	Rod (LxØ)	Batch
Cast steel				
FCB002	Blue	200x140 mm	600x10 mm	12
FCB003	Blue	300x180 mm	600x10 mm	10
Plated steel				
FCB006	Black	100x175 mm	500x10 mm	-
FCB007	Black	125x225 mm	500x10 mm	20
FCB008	Black	150x250 mm	600x10 mm	25
FCB009	Black	150x300 mm	900x10 mm	11

▶ Tripod support stands

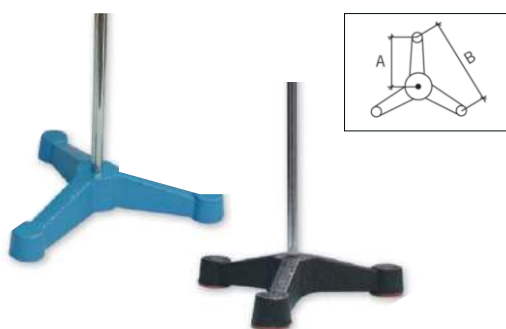

Code	Colour	A	B	Rod (LxØ)	Batch
FCB010	Blue	110 mm	170 mm	600x10 mm	-
FCB011	Blue	135 mm	210 mm	760x10 mm	-
FCB012	Blue	175 mm	300 mm	900x10 mm	6
FCB013	Blue	85 mm	130 mm	500x10 mm	-
FCB015	Black	135 mm	210 mm	760x10 mm	-
FCB016	Black	175 mm	300 mm	900x10 mm	7
FCB017	Black	85 mm	130 mm	500x10 mm	-

▶ FCD - Laboratory jacks

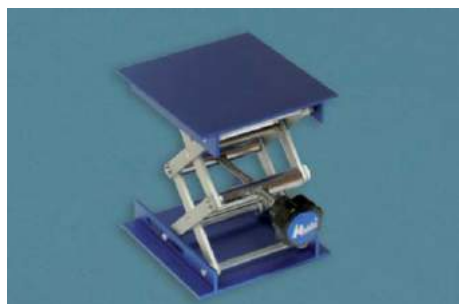

- 1| Made of aluminum with scissor type support
- 2| With manual knob, anti-slip legs and lateral hole for rods

Code	Dimensions	Maximum load
FCD001	10x10 cm	14 kg
FCD002	15x15 cm	27 kg
FCD003	20x20 cm	38 kg

▶ FCG - Clamps for burettes, tubes

▶ Clamps 2 prongs



1 | Made of chrome plated metal and prongs coated with PVC

Code	Opening	Length	Bosshead
FCG001	12-45 mm	210 mm	No
FCG002	20-60 mm	220 mm	No
FCG003	7-25 mm	205 mm	No
FCG004	12-45 mm	110 mm	Yes (fixed up to 17 Ø mm)
FCG005	4-20 mm	100 mm	Yes (fixed up to 14 Ø mm)
FCG006	7-25 mm	100 mm	Yes (fixed up to 14 Ø mm)
FCG007	12-45 mm	155 mm	Yes (rotary up to 18 Ø mm)
FCG008	7-25 mm	150 mm	Yes (rotary up to 18 Ø mm)



▶ Automatic clamps



1 | Made of chrome plated metal, to hold burettes and thermometers
2 | Fastener with spring, to hold diameters up to 25 mm

Code	Opening	Length	Bosshead	Rod (ØxL)
FCG009	0-25 mm	110 mm	Sí	-
FCG010	0-25 mm	160 mm	No	8x120 mm



▶ Clamps for 1 burette



Code	Opening	Colour
FCG011	Up to 20mm	White



▶ Double clamps for burettes



1 | Made of oven-coated aluminum
2 | With bosshead for rods up to 13 mm diameter

Code	Material	Colour	Batch
FCG012	Aluminum	White	20
FCG013	Plastic	White	20



▶ Clamps for burettes, PP



Code	Capacity	For rods of	Batch
FCG014	2 buretas	10 a 12 mm	6
FCG015	1 bureta	10 a 12 mm	6



▶ FCJ - FCJ-Clamps $\frac{3}{4}$ prongs

▶ Clamps 3 prongs without bosshead



1 | In chrome plated metal, with PVC coated prongs

Code	Opening	Length	Adjustment	Rod (ØxL)
FCJ001	0-30 mm	175 mm	Simple	8x125 mm
FCJ002	0-70 mm	240 mm	Simple, blue	8x150 mm
FCJ003	0-95 mm	240 mm	Simple, red	8x150 mm
FCJ004	0-95mm	240 mm	Simple, blue	12x140 mm
FCJ005	0-95mm	240 mm	Simple, blue	8x150 mm
FCJ006	0-50mm	210 mm	Double	10x140 mm
FCJ007	0-85 mm	250 mm	Double	12x155 mm

▶ Clamps 3 prongs with bosshead



1 | In chrome plated metal, with PVC coated prongs

2 | Rotary bosshead for rods up to 18 mm

Code	Opening	Length	Adjustment
FCJ008	0-30 mm	125 mm	Simple
FCJ009	0-70 mm	165 mm	Simple
FCJ010	0-60 mm	145 mm	Double
FCJ011	0-90 mm	170 mm	Double

▶ Clamps 4 prongs,



1 | Made of chrome plated metal, with coated prongs

2 | Opening 0/80mm

The model with rotary bosshead holds rods up to 18 mm Ø

Code	Length	Bosshead	Rod (ØxL)
FCJ012	230 mm	No	8x155 mm
FCJ013	250 mm	No	10x130 mm*
FCJ014	230 mm	No	12x145 mm
FCJ015	160 mm	Rotary	-

* Adjustable angle 180°

▶ FCK - Special clamps

▶ For thermometers



1 | Made of chrome plated metal, with rotary bosshead

2 | For rods up to 18 mm

Code	Length	Opening
FCK001	140 mm	6-15 mm

▶ FCK - Special clamps



▶ Suspension clamp for thermometers

- 1| Made of chrome plated metal, with fix bosshead
- 2| For rods up to 18 mm

Code	Length	Batch
FCK002	130 mm	2



▶ Chain clamp for big diameters

- 1| In stainless steel, with chain and spring clamp

Code	For diameters
FCK003	90/145 mm



▶ FCM - Clamps for ground joints

▶ Clips for tapered joints



- 1| In chrome plated metal for tapered ground joints

Code	Ground
FCM001	10/19
FCM002	14/23
FCM003	19/26
FCM004	24/29
FCM005	29/32
FCM006	45/40



▶ Clip POM



- 1| They don't scratch glass, autoclavable

Code	Colour	Ground	Batch
FCM007	Yellow	14/23	50
FCM008	Blue	19/26	80
FCM011	Green	24/29	50
FCM010	Red	29/32	25
FCM009	Brown	45/40	10



▶ Spherical joint clamp



- 1| Made of stainless steel, with screw lock for maximum safety
- 2| To hold spherical ground joints

Code	Joint diameter
FCM019	13 mm
FCM020	19 mm
FCM021	29 mm
FCM022	35 mm



▶ FCP - bossheads

▶ Double bossheads



REF. FCP009



1 | They allow assembling pieces in angles of 90°

Code	Description	Length	Varillas	Batch
FCP001	Painted small	53 mm	13 mm	10
FCP002	Painted medium	70 mm	16 mm	9
FCP003	Painted large	84 mm	21 mm	7
FCP004	Painted extra large	97 mm	25 mm	-
FCP005	Zinc plated small	53 mm	13 mm	9
FCP006	Zinc plated medium	70 mm	16 mm	9
FCP007	Zinc plated large	84 mm	21 mm	7
FCP008	Zinc plated extra large	97 mm	25 mm	7
FCP009	Zinc plated rounded	100 mm	16 mm	-

▶ Double, rotary



Code	Rods up to
FCP011	20/13 mm
FCP012	18 mm

▶ Double bosshead, resin coated



Code	Rods up to
FCP010	16 mm

▶ Bosshead model Phywe



1 | Metallic, cross arrangement

Code	Colour	Length	Rods up to
FCP013	Grey	170 mm	24 mm

▶ FCP - bossheads

▶ Universal bossheads



1| For parallel, perpendicular and T-shape arrangements

Code	Colour	Length	Rods up to	Batch
FCP014	Chrome plated	55 mm	16 mm	12
FCP015	Painted	55 mm	16 mm	25



▶ Bosshead para montajes



- 1| Bosshead type "P": to assemble two rods in right angle
2| Bosshead type "Trevin": to assemble multiple stands and in 3 different angles

Code	Model	Rods up to	Batch
FCP016	Type P	10 mm	-
FCP017	Type P	12 mm	10
FCP018	Type P	14 mm	-
FCP019	Type P	16 mm	-
FCP020	Trevin	9-13 mm	-



▶ FCR - Open retort rings



▶ With shank, chrome plated steel

- 1| Open retort ring without bosshead, made of chrome plated steel
2| For retort stands, tripod support stands, etc.

Code	Int. Ø	Total length	Shank length
FCR001	45 mm	215 mm	155 mm
FCR002	80 mm	255 mm	155 mm
FCR003	105 mm	255 mm	155 mm
FCR004	120 mm	270 mm	150 mm



▶ With bosshead, chrome plated steel

- 1| Open retort ring with bosshead, made of chrome plated steel
2| For retort stands, tripod support stands, etc.

Code	Diameter	Length (center/bosshead)
FCR009	50 mm	95 mm
FCR010	80 mm	130 mm
FCR011	100 mm	130 mm
FCR012	140 mm	110 mm



▶ FCV - Closed retort rings



▶ With shank, chrome plated steel



- 1| Closed retort ring without bosshead, made of chrome plated steel
- 2| For retort stands, tripod support stands, etc.

Code	Int. Ø	Total length	Shank length
FCV001	45 mm	200 mm	155 mm
FCV002	65 mm	225 mm	155 mm
FCV003	85 mm	250 mm	155 mm
FCV004	105 mm	255 mm	155 mm

▶ With bosshead, chrome plated steel



- 1| Closed retort ring with bosshead, made of chrome plated steel
- 2| For retort stands, tripod support stands, etc.

Code	Diameter	Length (center/bosshead)
FCV005	50 mm	110 mm
FCV006	80 mm	110 mm
FCV008	125 mm	150 mm

▶ FCY - Rods without thread



▶ Rods for laboratory frameworks



Code	Material	Diameter	Length
FCY002	Chrome plated	12 mm	60 mm
FCY003	Chrome plated	12 mm	200 mm
FCY004	Chrome plated	12 mm	350 mm
FCY005	Chrome plated	12 mm	700 mm
FCY006	Chrome plated	12 mm	1000 mm
FCY007	Chrome plated	12 mm	2000 mm
FCY008	Steel	12 mm	60 mm
FCY009	Steel	12 mm	200 mm
FCY010	Steel	12 mm	350 mm
FCY011	Steel	12 mm	700 mm
FCY012	Steel	12 mm	1000 mm
FCY013	Steel	12 mm	2000 mm
FCY014	Stainless steel	12 mm	60 mm
FCY015	Stainless steel	12 mm	200 mm
FCY016	Stainless steel	12 mm	350 mm
FCY018	Stainless steel	12 mm	1000 mm
FCY019	Stainless steel	12 mm	2000 mm

▶ FFB - Tripod stand



▶ Round



- 1| Ring with round section, with rubber caps in the legs

Code	Material	Diameter	Height
FFB001	Steel	125 mm	200 mm
FFB002	Steel	150 mm	200 mm
FFB003	Steel	185 mm	200 mm
FFB004	Stainless steel	120 mm	200 mm
FFB005	Stainless steel	150 mm	200 mm

▶ FFB - Tripod stand



▶ Triangular

- 1 | Rings and legs made of steel, ring with triangular section
- 2 | With rubber caps in the legs

Code	Side	Height
FFB006	120 mm	200 mm
FFB007	150 mm	200 mm
FFB008	160 mm	200 mm



▶ FFD - Iron wire gauze



- 1 | With ceramic fiber center, without asbestos.
- 2 | To heat substances with Bunsen

Code	Dimensions	Ceramic Ø	Batch
FFD001	12x12 cm	80 mm	20
FFD002	15x15 cm	100 mm	20
FFD003	20x20 cm	145 mm	20



▶ FFG - Triangles

▶ Pipeclay triangles



- 1 | Composed of three fireclay tubes made of pipeclay. Joined in triangle shape by thick wires of galvanized metal

Code	Side length	Tube Ø
FFG001	30 mm	9 mm
FFG002	50 mm	8 mm
FFG003	65 mm	8 mm
FFG004	90 mm	8 mm



▶ FFJ - Burners

▶ Alcohol lamps



Code	Description
FFJ002	Alcohol lamp safety system
FFJ007	Meter of wick (in pieces of 20 cm) for lamps



FFJ - Burners

Laboratory burners



Nahita

- 1 | With adjustable gas and air inlets
- 2 | Tapered serrated gas connection

Code	Description	Batch
FFJ003	Micro Bunsen burner, natural gas	-
FFJ004	Micro Bunsen burner, GLP	-
FFJ005	Bunsen burner, natural gas	30
FFJ006	Bunsen burner, GLP	30

FFL - Tongs for crucibles and evaporating dishes

For crucibles, chromed plated steel

Nahita

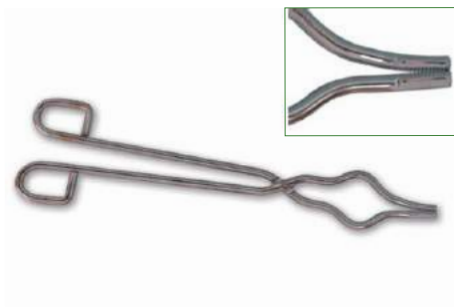

- 1 | With narrow neck and curved serrated tips to ensure grip

Code	Total length	Opening
FFL001	150 mm	20 mm
FFL002	200 mm	28 mm
FFL003	250 mm	32 mm
FFL004	300 mm	32 mm
FFL005	350 mm	32 mm
FFL006	400 mm	40 mm
FFL007	450 mm	40 mm

For crucibles, stainless steel

Nahita

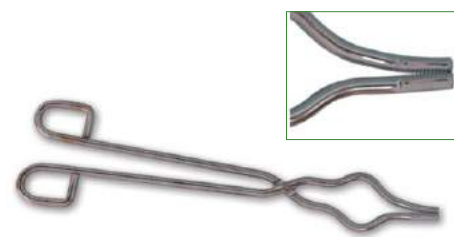

- 1 | With narrow neck and curved serrated tips to ensure grip

Code	Total length	Opening
FFL009	200 mm	25 mm
FFL010	250 mm	28 mm
FFL011	300 mm	32 mm

For evaporating dishes, stainless steel

Nahita

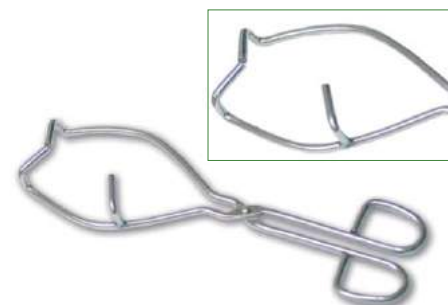

- 1 | For porcelain dishes u other flat bottom containers

Code	Total length	Opening
FFL012	260 mm	65/190 mm

▶ FFN - Beaker tongs, tube clamps



▶ For beakers, 2 and 3 prongs

1 | Made of stainless steel, with PVC coated prongs for a better grip

Code	Model	Opening	Length
FFN001	2 prongs	50/150 mm	275 mm
FFN002	3 prongs	0/160 mm	250 mm
FFN003	3 prongs	0/220 mm	300 mm

▶ For test tubes

1 | For test tubes up to 25 mm diameter

Code	Model	Length	Batch
FFN005	Steel	150 mm	10
FFN006	Wood	180 mm	10



▶ FHD - Clamps

▶ Hoffman



- Made of nickel plated metal
- They have a compressor screw and a base with two positions; open or closed

Code	Opening
FHD001	12 mm
FHD002	17 mm
FHD003	20 mm
FHD004	25 mm
FHD005	30 mm
FHD006	40 mm



▶ Mohr



1 | Made of nickel plated metal

Code	Length
FHD007	40 mm
FHD008	50 mm
FHD009	60 mm
FHD010	70 mm
FHD011	80 mm



▶ FHN - Laboratory tubing

▶ White rubber tubing



- In white natural rubber
- Supplied in roll of 10 meters

Code	Int. Ø	Ext. Ø
FHN001	10 mm	14 mm
FHN002	4 mm	6 mm
FHN003	5 mm	7 mm
FHN004	9 mm	12 mm



▶ FKB - Spatula-spoon

▶ Spatula-spoon, flat



Nahita

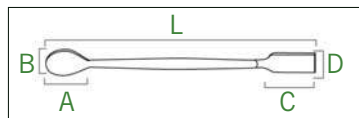

1 | Made of stainless steel

Code	Length	AxB	CxD	Batch
FKB005	150 mm	15x20 mm	25x12 mm	10
FKB006	200 mm	30x20 mm	32x15 mm	50
FKB007	230 mm	30x20 mm	30x15 mm	-

page
[82]

▶ Flat spoon, reinforced



Nahita

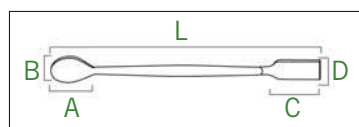

1 | Made of stainless steel

Code	Length	AxB	CxD	Batch
FKB008	100 mm	20x15 mm	22x13 mm	-
FKB009	125 mm	20x14 mm	18x14 mm	10
FKB010	150 mm	25x19 mm	25x19 mm	10
FKB011	200 mm	30x25 mm	30x25 mm	10
FKB012	250 mm	28x21 mm	90x23 mm	-

▶ Groove spoon spatula



Nahita

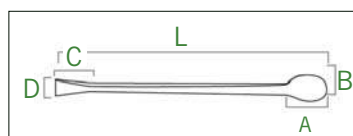

1 | Made of stainless steel

Code	Length	AxB	CxD
FKB015	120 mm	15x13 mm	15x10 mm
FKB016	140 mm	20x15 mm	17x11 mm
FKB017	160 mm	25x18 mm	17x12 mm
FKB018	180 mm	30x20 mm	20x13 mm

▶ Set of 3 groove spatulas



Nahita

1 | Made of stainless steel

Code	FKB019
Composed of:	
	Groove spoon spatula 120 mm
	Groove spoon spatula 140 mm
	Groove spoon spatula 160 mm

▶ FKB - Spatula-spoon

▶ Flat-curved spoon spatula

Nahita

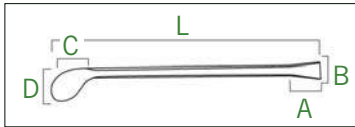

1 | Made of stainless steel

Code	Length	AxB	CxD
FKB020	195 mm	20x13 mm	30x20 mm



▶ Spoon-spatula, for analysis

Nahita

1 | Made of stainless steel

Code	Length	AxB	CxD
FKB021	224 mm	40x19 mm	48x10



▶ Trough spatula, groove spoon

Nahita

1 | Made of stainless steel

Code	Length	AxB	CxD	Batch
FKB022	200 mm	30x24 mm	90x17 mm	10

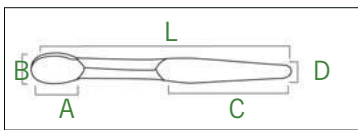

▶ Spoon spatula

Nahita

1 | Made of porcelain, glazed

Code	Length	Width
FKB023	88 mm	13 mm



▶ Spoon spatula

JIP

1 | In glazed porcelain

Code	Length
FKB024	103 mm
FKB025	148 mm
FKB026	164 mm
FKB027	187 mm
FKB028	200 mm
FKB029	250 mm



▶ FKB - Spatula-spoon

▶ Espátula-cuchara, PP



- 1 | High resistance to chemical agents and solvents
- 2 | They can be sterilized in autoclave

Code	Colour	Length	Batch
FKB030	Blue	16 cm	100
FKB031	Blue	18 cm	100
FKB032	Blue	20 cm	100
FKB033	Red	16 cm	100
FKB034	Red	18 cm	100
FKB035	Red,	20 cm	100

▶ FKD - Microspatula spoon



- 1 | In stainless steel

Code	Length	Spoon (LxW)	Spatula (LxW)
FKD001	190 mm	35x9 mm	50x9 mm
FKD002	230 mm	35x16 mm	57x9 mm

▶ FKG - Spatulas

▶ Spatula with handle

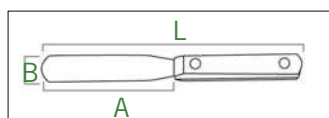

Code	Length	AxB
FKG005	170 mm	80x20 mm
FKG001	190 mm	100x20 mm
FKG002	210 mm	120x20 mm

▶ Spatula with wooden handle



Code	Length	Spatula (LxW)
FKG006	215 mm	100x20 mm
FKG007	270 mm	150x25 mm
FKG009	315 mm	200x25 mm

FKL - Double spatula

Flat-flat reinforced



1 | In stainless steel

Code	Total length	Spatula (LxW)
FKL001	150 mm	35x18 mm
FKL002	200 mm	45x18 mm



Flat-flat



1 | In glazed porcelain

Code	Total length	Batch
FKL003	104 mm	5
FKL004	186 mm	5
FKL005	250 mm	5
FKL006	298 mm	5



page
[85]

FKN - Double spatula, micro



Flat groove



1 | In stainless steel

Code	Total length	Spatula (LxW)
FKN007	150 mm	30x5 mm
FKN008	200 mm	30x5 mm

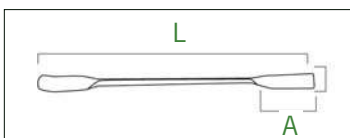

Code	Length	AxB	Batch
FKN001	100 mm	25x8 mm	-
FKN002	120 mm	25x9 mm	-
FKN003	150 mm	25x9 mm	-
FKN004	170 mm	30x9 mm	10
FKN005	150 mm	28x6 mm	-



FKP - Spoons

Filled spatula



Code	Length	Spoon (LxW)	Spatula (LxW)
FKP001	215 mm	25x11 mm	50x9 mm



FKP - Spoons

▶ Spoon



1 | In glazed porcelain

Code	Length
FKP002	237 mm

page
[86]

▶ Spoon

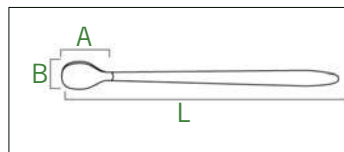

1 | Made of stainless steel

Code	Length	AxB	Batch
FKP003	125 mm	20x13 mm	10
FKP004	160 mm	15x15 mm	10
FKP005	180 mm	25x18 mm	-
FKP006	220 mm	30x18 mm	-

FKR - Double spoon

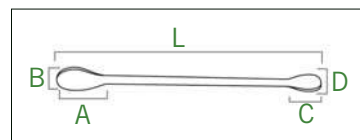

Code	Length	AxB	CxD	Batch
FKR001	160 mm	25x18 mm	15x11 mm	10
FKR002	200 mm	30x20 mm	25x15 mm	10

FKW - Scoops

▶ Measuring scoop



1 | Made of high density polyethylene
2 | For food use, neutral colour

Code	Capacity	Total length	Useful length
FKW001	1100 ml	36 cm	24 cm
FKW002	250 ml	24 cm	15,5 cm
FKW003	2500 ml	40 cm	28,5 cm
FKW004	600 ml	30 cm	19,5 cm

FM - MATERIAL DE DISECCIÓN



Dissection items are for educational and veterinary use only, not for medical use. Except those with the CE mark.

Disinfect before use

Wash hands with antibacterial soap before use

Don't use instruments with rust or corroded in any case

Never left any dirty instrument to dry

Wet immediately

Instruments can be sterilized in autoclave:

1. Use distilled water
2. Remove rests of blood tissue with a nylon brush
3. Leave the instruments open during autoclave process. Place thin and sharp parts in the upper part of the equipment
4. Autoclave 4/6 minutes at 132°C (270°F)
5. Dry 4/5 minutes
6. Don't leave instruments in the autoclave
7. After sterilization, leave a drop of silicone oil for a proper operation

page
[87]

FMB - Scalpels/Knives



Histologic folding knife

- 1 | Stainless steel blade

Code	Length	Handle
FMB001	110 mm	Metal
FMB002	110 mm	Plastic



Scalpel fixed blade

- 1 | In stainless steel

Code	Total length	Blade length
FMB003	150 mm	40 mm



Disposable scalpels

- 1 | Blade of carbon steel, plastic handle
- 2 | Sterile CE0434
- 3 | Individually packed. Supplied in boxes of 10 units

Code	Number	Length
FMB004	10	135 mm
FMB005	11	135 mm
FMB006	15	135 mm
FMB007	20	160 mm
FMB008	21	160 mm
FMB009	22	160 mm
FMB010	23	160 mm
FMB011	24,	160 mm



FMB - Scalpels/Knives

▶ Scalpel handle n°3



1 | In stainless steel

Code	Number	Total length
FMB020	n° 3 long	200 mm
FMB021	n° 3	125 mm

▶ Scalpel handle n°4



1 | Scalpel blades

Code	Number	Total length
FMB022	n° 4 long	220 mm
FMB023	n° 4	140 mm

▶ Scalpel blades



- 1 | Made of carbon steel
- 2 | The number assigns a universal form that identifies size and shape
- 3 | Sterile CE0434
- 4 | Individually packed. Supplied in boxes of 100 units

Code	Number	For handle n°
FMB012	N° 10	3
FMB013	N° 11	3
FMB014	N° 15	3
FMB015	N° 20	4
FMB016	N° 21	4
FMB017	N° 22	4
FMB018	N° 23	4
FMB019	N° 24	4
FMB025	N° 12	4

▶ Lancets



- 1 | Made of stainless steel
- 2 | Disposable, single use to take capillary blood
- 3 | Sterile CE0434
- 4 | Individually packed. Supplied in boxes of 200 units

Code
FMB024

FMD - Dissection needles

▶ Straight pin



- 1 | Stainless steel needle
- 2 | Metal handle

Code	Total length
FMD001	125 mm
FMD002	145 mm

FMD - Dissection needles

▶ Straight pin, lancet shape



1 | Needle in stainless steel

Code	Total length	Handle
FMD003	145 mm	Stainless
FMD004	135 mm	Plastic



▶ Histologic needle, curved



1 | Needle in stainless steel

Code	Total length
FMD005	140 mm



▶ Catheter



1 | In stainless steel

Code	Total length
FMD006	140 mm
FMD007	200 mm



▶ Grooved probe



1 | In stainless steel

Code	Total length
FMD008	140 mm



FMG - Curved forceps

▶ London-College



1 | Curved tip, in stainless steel

Code	Total length
FMG001	115 mm
FMG002	150 mm



▶ Laboratory forceps



1 | Curved tip, in stainless steel

Code	Total length
FMG003	110 mm



FMJ - Special forceps

Dissecting forceps, without teeth



Nahita

1 | Straight and striated tip

Code	Total length
FMJ001	125 mm
FMJ002	140 mm
FMJ003	160 mm
FMJ004	200 mm
FMJ005	250 mm

Thin tip



Nahita

1 | Sharp tip in stainless steel

Code	Total length
FMJ006	115 mm
FMJ007	140 mm

With teeth



Nahita

- 1 | Instead of striated tip, they have teeth that fit in the opposite side teeth
- 2 | Used to hold gauzes, they also provide a firm grip in skin and hard tissues

Code	Teeth	Total length
FMJ008	1:2 teeth	125 mm
FMJ009	1:2 teeth	140 mm
FMJ014	1:2 teeth, thin tip	140 mm
FMJ010	1:2 teeth	160 mm
FMJ011	1:2 teeth	200 mm
FMJ012	2:3 teeth	130 mm
FMJ013	2:3 teeth	145 mm

FML - Pinzas especiales

Forceps Feilchenfeld



Nahita

1 | Stainless steel. Suitable for autoclave sterilization, suitable for ultrasonic cleaning.

Code	Total length
FML002	110 mm
FML003	90 mm

Forceps Feilchenfeld



Nahita

1 | In stainless steel

Code	Total length
FML004	140 mm

▶ FML - Special forceps

▶ Forceps "Kocher"



- 1| They have a mechanism with teeth which keeps the forceps fixed without pressing once they are closed. They are released easily
- 2| In stainless steel

Code	Model	Total length
FML005	Mosquito straight	120 mm
FML015	Curved	140 mm
FML016	Curved	160 mm
FML017	Straight	140 mm



▶ For insects



- 1| In stainless steel

Code	Total length
FML006	100 mm



▶ Specials



Code	Description
FML007	Forceps spring effect
FML010	Forceps for slides (flat tip)



▶ Forceps "Rochester-Pean"



- 1| In stainless steel

Code	Total length
FML008	160 mm



▶ Forceps very thin tips

- 1| Thin tip, in stainless steel

Code	Total length
FML009	110 mm



FML - Special forceps

▶ Needle holders



- 1 | To pick and hold surgical needles, they have short and strong branches
- 2 | The size of the needle holder must be in accordance with the size of the needle:
 - Baumgartner for thin needles
 - Mayo-Hegar for thick needles

Code	Model	Total length
FML011	Baumgartner	140 mm
FML012	Baumgartner	180 mm
FML013	Mayo-Hegar	140 mm
FML014	Mayo-Hegar	180 mm

FMN - Scissors

▶ Surgical, curved



- 1 | Made of stainless steel
- 2 | They can be repeatedly cleaned in ultrasonic bath or sterilized in autoclave

Code	Model	Total length
FMN001	Sharp-sharp	140 mm
FMN004	Sharp-blunt	130 mm
FMN005	Sharp-blunt	160 mm
FMN006	Blunt-blunt	125 mm
FMN007	Blunt-blunt	140 mm

▶ Surgical, straight



- 1 | Made of stainless steel
- 2 | They can be repeatedly cleaned in ultrasonic bath or sterilized in autoclave

Code	Model	Total length
FMN009	Straight sharp-sharp	115 mm
FMN010	Straight sharp-sharp	140 mm
FMN011	Straight sharp-sharpa	160 mm
FMN012	Straight sharp-blunt	125 mm
FMN013	Straight sharp-blunt	140 mm
FMN014	Straight sharp-blunt	160 mm
FMN015	Straight blunt-blunt	140 mm
FMN016	Straight blunt-blunt	160 mm

▶ Mayo



Code	Model	Total length
FMN018	Curved	140 mm
FMN019	Straight	140 mm
FMN020	Straight	160 mm

▶ FMN - Scissors

▶ Tungsten scissors



Code	Model	Total length
FMN021	Sharp-sharp	130 mm
FMN022	Sharp-blunt	130 mm
FMN023	Iris	110 mm
FMN024	Metzenbaum	140 mm



▶ Micro scissors Noye



Code	Total length
FMN025	115 mm



▶ Scissors Iris



1 | In stainless steel

Code	Total length
FMN026	116 mm



▶ Scissors Metzenbaum



1 | In stainless steel

Code	Total length
FMN028	140 mm



▶ Scissor for bandages Lister



1 | In stainless steel

Code	Total length
FMN029	140 mm



▶ Scissors Spencer



1 | En acero inoxidable.

Code	Total length
FMN030	130 mm



▶ FMQ - Dissection kits

▶ 15 pieces



Code FMQ001

Includes:

- 1 catheter
- 1 grooved probe
- 1 Baumgartner needle holder
- 1 scalpel handle n°3
- 1 scalpel handle n°4
- 1 surgical scissors, straight, sharp-blunt
- 1 surgical scissors, curved, sharp-blunt
- 1 scissors Mayo, straight
- 1 scissors Mayo, curved
- 1 dissection forceps 1:2 teeth
- 1 dissection forceps without teeth
- 1 hemostatic forceps, curved
- 1 hemostatic forceps, straight
- 1 hemostatic forceps Mosquito, straight
- 1 dissection needle

▶ 9 pieces



Code FMQ002

Includes:

- 1 catheter
- 1 grooved probe
- 1 Baumgartner needle holder
- 1 scalpel handle n°3
- 1 scalpel handle n°4
- 1 scissors curved sharp-blunt
- 1 scissors straight sharp-blunt
- 1 forceps with 1:2 teeth
- 1 forceps without teeth
- 1 dissection case

▶ With snap closure



- 1 | With snap closure
- 2 | Supplied without instruments

Code	Model	Dimensions (LxA)
FMQ004	3 pieces	160x90 mm
FMQ005	6 pieces	180x100 mm
FMQ003	12 pieces	168x105 mm

▶ Empty case



- 1 | Brown external colour, red inside
- 2 | Supplied without instruments

Code	Model
FMQ006	9 pieces
FMQ007	15 pieces

FZB - Stabilizing rings



- 1 | To stabilize bottles, flasks... preventing them from floating when they are immersed
- 2 | Made of PVC coated steel

Code	Diameter	Wigth (prox.)
FZB001	48 mm	270 g
FZB002	56 mm	520 g
FZB003	61 mm	780 g
FZB004	74 mm	960 g



FZD - Glass markers



Code	Model
FZD003	Glass marking pencil, diamond tip
FZD002	Glass marking pencil, Chinagraph



FZG - Compasses



Code	Description	Diameter	Batch
FZG001	Aluminum compass	40 mm	25
FZG002	Initiation compass	44 mm	-
FZG003	Directional compass	53 mm	-
FZG004	Plastic compass	55 mm	20



LABORATORY
SUPPLIERS

SERVICES

TRADEMARKS

STOCK

COMPETITIVITY

AUXILAB
+ ROGO
SAMPAIC



ENDO
glassware

Own brand of the group Auxilab/ Rogo Sampaic.
Please know the wide range of laboratory glass
products we offer at your disposal. Glass of quality at a
competitive price to satisfy all your needs



[G] INDEX OF CONTENTS CENTRIFUGES

[GB] Single-rotor 99
 GBC - Bench top, analogical99
 GBF - Bench top, digital.....99
 GBK - Accessories101

[GD] Minicentrifuges 102
 GDC - Minicentrifuges102
 GDF - Accessories103

[GG] Microhematocrit 103
 GGC - Bench top103
 GGF - Accessories104

[GJ] For microtubes 104
 GJC - Bench top104
 GJK - Accessories, rotors105

[GL] Universal 105
 GLC - Bench top105
 GLF - Bench top, refrigerated106
 GLH - Accessories, rotors106





[GN] High capacity 107
 GNC - Bench top107
 GNP - Accessories, adapters107







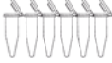

TRADEMARKS:



CHARTS: 'Tube compatibility'

Consult the compatibility of our centrifuges with different types of tubes and microtubes

Description Capacity	Microtube 1,5 / 2 mL	Microtube 0,5 mL	Microtube 0,2 mL	PCR strips 0,2 mL	Microhematocrit Capillary	Microplates
						
GBC001						
GBC002						
GBC003						
GBF001						
GBF003						
GBF006						
GBF008						
GDC001	8	8	8	2		
GDC002	8	8	8	2		
GDC003	8	8	8	2		
GDC004	8	8	8	2		
GDC005	8	8	8	2	12	
GGC001					24	
GGC002					24	
GJC002	24	36		4	24	
GJC006	12	12*	12*			
GLC001						
GLF001	12 or 24	36				
GNC001						4

Description Capacity	Tube 15 mL 16x100 mm	Tube 10 mL 13x100 mm	Tube 10 mL 16x80 mm	Tube 5 mL 12x75 mm	Tube 5 mL 13x53 mm	Falcon type 15 mL	Falcon type 50 mL	Tube 100 mL 40x100 mm	Tube 250 mL 60x130 mm
									
GBC001	12					6			
GBC002	12								
GBC003				16					
GBF001	6	6*		6*		6			
GBF003	12			12*		12			
GBF006	8								
GBF008	6	6		6		6			
GBF010	12	12*		12*					
GDC001									
GDC002									
GDC003									
GDC004									
GDC005									
GGC001									
GGC002									
GJC002					10				
GLC001						16	8	4	
GLF001			12		10		6		
GNC001		48		72		24 or 32	4 or 8	4	4

* with additional adapters

▶ Comparative charts for centrifuges models

Code	Model	Adjustment	Max. speed (rpm)	Max. RCF(xg)
GBC001	2650	Analogical	4000	2147
GBC002	2690	Analogical	5000	3130
GBC003	2690/5	Analogical	5000	3130
GBF001	2615/1	Digital	4000	1790
GBF003	2640/12	Digital	4000	2432
GBF006	2698	Digital	4000	2000
GBF008	Fugelab-GB8	Digital	6500	3684
GBF010	Fugelab-GB10			
GDC001	2507/7		7200	3260
GDC002	2507/10		10000	5610
GDC003	2507/15		10000	5610
GDC004	2507/25		10000	5610
GDC005	Fugevet		12000	5610
GGC001	2900	Analogical	12000	15300
GGC002	2924	Digital	12000	15300
GJC002	2624/2	Digital	15000	20375
GJC006		Digital	15000	15596
GLC001	Medibas+	Digital	4000	2790
GLF001	Multifrig	Digital	18500	25330
GNC001	Multibas+	Digital	5000	4980

▶ GBC - Bench top, analogical



▶ Series 2600

- 1 | Steel casing furnace-painting.
- 2 | Angular rotor.
- 3 | Elastic rotor suspension with brushes.
- 4 | Safety lid device.



Code	GBC001	GBC002	GBC003
Model	2650	2690	2690/5
Capacity	12x15mL	12x15mL	16x5mL
Working mode	Continuous o timer		
Timer (min)	1-30	1-30	1-30
Speed range (rpm)	500-4000	500-5000	500-5000
Adjustment de la velocidad	In steps of 500 rpm		
RCF max. (g)	2147	3130	3130
Dimensions approx. (cm)	29x36x27	41x38x38	41x38x38
Weight approx. (Kg)	15	15	15

▶ GBF - Bench top, digitals



▶ Series 2615/1

- 1 | Steel casing furnace-painting.
- 2 | Angular rotor.
- 3 | Elastic suspension motor.
- 4 | Lid safety device.



Code	GBF001
Capacity	6x15mL
Timer (min)	1-59
Speed range (rpm)	1000-4000 (steps of 500)
RCF max. (g)	1790
Dimensions approx. (cm)	28x28x25
Weight approx. (Kg)	5



GBF - Bench top, digital



▶ Series 2640 'ECO'



- 1 | External body made of high quality ABS plastic with steel base and sucking feet.
- 2 | Angular rotor.
- 3 | LED display .
- 4 | Motor de suspensión elástica, con escobillas.
- 5 | Electromagnetic safety and system of emergency lid opening in case of block due to accidental power failure.
- 6 | Possibility of programming speed (rpm) or RCF (g).

Code	GBF003
Model	2640/12
Capacity	12x15mL
Timer	1-99min / continuous mode / short spin
Speed range (rpm)	200-4000 (steps of 10)
RCF max. (g)	2432
Dimensions approx. (cm)	38x31x29
Weight approx. (Kg)	13

▶ Series 2600



- 1 | Steel casing furnace-painting.
- 2 | Angular rotor
- 3 | Safety switch that avoids centrifugation if the lid is open and that automatically stops operation in case of opening the lid.

Code	GBF006
Model	2698
Capacity	8x15mL
Timer (min)	1-99
Speed range (rpm)	100-4000
Adjustment de la velocidad	(steps of 100 rpm)
RCF max. (g)	2000
Dimensions approx. (cm)	32x32x28
Weight approx. (Kg)	15

▶ Fugelab - GB08



- 1 | Digital display (LED) with time and speed indicators..
- 2 | Possibility of setting speed or RCF..
- 3 | Sound alarm at the end of operation and automatic lid opening.
- 4 | Metallic and autoclavable angle rotor and tube holders.
- 5 | Robust metal base and ABS plastic case. Metal lid with ABS cover..
- 6 | Lid safety device with electromagnetic lock.
- 7 | Maintenance-free induction motor.

Code	GBF008
Head	Angular (angle of 25°)
Max. capacity.	8 x 15/20 mL (tubes Ø 18 mm x L 90-120 mm) 8 adapters (tubes Ø 13 mm x L 75-100 mm) 8 adapters (tubes Ø 13 mm x L 55-75 mm)
Speed range	500 - 6500 rpm (steps of 100)
RCF máx.	3684 g
Timer	1-30 min; mode continuous
Acceleration time	25 seconds
Deceleration time	39 seconds
Dimensions (LxAxH)	260x244x203 mm
Weight	4 Kg
Power supply	100-230 VAC, 50/60 Hz

▶ GBF - Bench top, digital



▶ Centrifuga angular digital Fugelab - GB10

- 1| Case and lid with metal base. Plastic rotor and tube holders.
- 2| Possibility of setting rpm or FCR.
- 3| Memory of the last program run.
- 4| Short spin function.
- 5| Sound alarm and automatic lid opening at the end of operation.
- 6| Emergency lid opening system in case of power failure.
- 7| Lid safety device with double lock (mechanic and electromagnetic locks).
- 8| Maintenance-free induction motor.









Code	GBF010
Rotor	Fixed-angle
Max. capacity	12x15 mL
Speed range	100- 4000 rpm (steps of 10)
Max. RCF	1770 g (steps of 10)
Timer	1-99 min
Dimensions (LxWxH)	485x375x290mm
Weight	16 kg
Power	230 V AC, 50Hz
Noise (maximum speed)	≤65dB(A)

page
[101]

▶ GBK - Accessories

▶ CHART 1: 'Single-rotor accesories 2615/1 - 2640 - 2650 - 2690 - 2690/5 - 2698/5 - 2698'

	Code	Description	Model					
			2615/1	2640	2650	2690	2690/5	2698
	GBK001	Set of accessories 6 tube holders for 15 mL tubes 6 rubber cushions and 1 fuse	■					
	GBK002	Adapter tubes 10 mL Dimensions: 13x100 mm	■					
	GBK003	Adapter tubes 5 - 7 mL	■					
	GBK004	Brushes	■					
	GBK005	Plastic tube holder		■				
	GBK006	Adapter for 5 ml tubes Dimentiosn: 12x75 mm		■				
	GBK007	Pair of brush for centrifuges		■				





 = Accesories **included** with indicated item

 = Accesories **compatible** with indicated item

GBK - Accessories



▶ CHART 1: 'Single-rotor accessories 2615/1 - 2640 - 2650 - 2690 - 2690/5 - 2698/5 - 2698'

	Code	Description	Model						
			2615/1	2640	2650	2690	2690/5	2698/5	2698
	GBK008	Brushes			■	■	■		
	GBK009	Aluminium tube holder 15 mL				■			
	GBK010	Aluminium holder tubes 5 mL					■	■	
	GBK011	Rubber ferrule for tubes 16x100			■	■			
	GBK012	Rubber ferrule for tubes 12x75					■	■	

i = Accessories **included** with indicated item

■ = Accessories **compatible** with indicated item

GDC - Minicentrifuges



▶ Series 2507



- 1 | Very useful in PCR, sample preparation for HPLC and microfiltration.
- 2 | Included angle rotor with adapters and strip rotor.
- 3 | Rotors can be changed easily and quickly without using a key.
- 4 | Interruptor de seguridad en tapa que detiene el rotor en caso de apertura.
- 5 | Very silent and stable thanks to their suction pads.
- 6 | Switched source 85-240V, 50/60Hz, except model 2507/25 suitable for car (DC12V).

Code	GDC001	GDC002	GDC003	GDC004
Model	2507/7	2507/11	2507/15	2507/25 (car)
Capacity				
Angular rotor		8x1,5/2mL 8x0,5mL* 8x0,2mL*		
Strip rotor		2 strips of 8x0.2 mL		
Speed (rpm)	7200	10000	4000/7000/10000	
RCF max. (g)	3260	5610	990/2910/5610	
Dimensions approx. (cm)			16x18x13	
Weight approx. (Kg)			0.8	

* Using the included adapters

GDC - Minicentrifuges



Fugevet model

- 1 | Designed for the veterinary sector.
- 2 | With 1 rotor for microhematocrit tubes, 1 angle rotor with adapters and 1 stripes rotor.
- 3 | 'Click system' to change rotors.
- 4 | Lid safety system that stops the rotor when open.
- 5 | Silent and stable thanks to its suction feet.
- 6 | Power supply 85-240 V, 50/60 Hz.



Code	GDC005
Capacity	Rotor for 12 microhematocrit tubes Rotor for 8 microtubes: 8x1.5/2 mL, 8x0.5 mL*, 8x0.2 mL* Rotor for 4 cryotubes:: 4x5 mL, 4x1.8 mL* Stripes rotor (8x0.2 mL)
Speed	4000/7000/12000 rpm
RCF	990/ 2910/ 5610 g
Dimensions aprox.	155 x 175 x 125 mm
Weight approx.	±0,8 Kg
Powe supply	AC 85-240V, 50/60Hz













* Using the included adapters

page
[103]

GDF - Accessories



CHART 2: 'Minicentrifuges accessories 2507/7 - 2507/10 - 2507/15 - 2507/25 - Fugevet'

	Code	Capacity	Model				
			2507/7	2507/11	2507/15	2507/25	Fugevet
	GDF001	Adapter for microtubes 0.2 mL					
	GDF002	Adapter for microtubes 0.5 mL					

 = Accesories **included** with indicated item

 = Accesories **compatible** with indicated item

GGC - Microhematocrit, bench top



Models 2900 and 2924

- 1 | Microhaematocrit rotor with numerated positions to identify samples easily.
- 2 | Security switch to avoid centrifue operation when safety-lid is open.
- 3 | Maitenance-free induction motor (model 2924).



Code	GGC001	GGC002
Control	Analogical	Digital
Capacity	24 capillary	
Timer (min)	1-10	1-99
Speed range (rpm)	500 - 12000 (steps of 100)	
RCF max. (g)	15300	
Dimensions approx. (cm)	31x31x27	27x27x20
Weight approx. (Kg)	15	12



GGF - Accessories



▶ CHART 3: 'Microhematocrit accessories 2900 - 2924'

	Code	Description	Model	
			2900	2924
	GGF001	Brushes	<input type="checkbox"/>	<input type="checkbox"/>
	GGF002	Silicone joint for centrifuge	<input type="checkbox"/>	<input type="checkbox"/>

 = Accessories **included** with indicated item

= Accessories **compatible** with indicated item

GJC - For microtubes, bench top

▶ Model 2624/2



- 1 | Furnace painted steel casing and base. The lid is equipped with suspension mechanisms.
- 2 | Multiple optional rotors, agular and for microhematocrit
- 3 | LED display and y selector mono-mando.
- 4 | It's induction motor without brushes makes this equipment free of periodic maintenance.
- 5 | The lid is equipped with suspension mechanisms to avoid accidents during the centrifuge loaded or emptied.

Code	GJC002
Timer	1-99s / 1-99min / Short spins
Speed range (rpm)	100-15000 (steps of 10)*
RCF max. (g)	20375 g*
Capacity	check available rotors
Dimensions approx. (cm)	36x28x26
Weight approx. (kg)	15

* Refer to rotor chart

▶ Digital centrifuge for microtubes, HiFuge-GJ6











- 1 | Large backlit LCD display
- 2 | Fixed angle rotor made of high strength plastic
- 3 | Possibility of setting speed or RCF. Short spin function
- 4 | Max. capacity 12 microtubes of 2/1.5 mL
- 5 | Overspeed protection system
- 6 | Maintenance-free brushless motor

Reference	GJC006
Rotor	Fixed-angle rotor with lid
Speed range	500-15000 rpm (steps of 100 rpm)
Max. RCF	15100 xg
Timer	30 sec – 99 min/Continuous mode
Max. capacity	12 x 2/1.5 mL
Acceleration/Braking time	11 sec / 9 sec
Dimensions	255x245x140 mm
Weight	4.6 Kg
Power	110-240V, 50-60Hz

▶ GJK - Accessories, rotors

▶ **TABLA 4:** 'Accessories for microtubes centrifuge 2624/2'

	Code	Description	Max. speed	RCF	Model 2624/2
	GJK001	24 microtubes 1.5 - 2 mL	1500 rpm	20375 g	
	GJK002	24 capillaries microhematocrit	12000 rpm	15455 g	
	GJK003	10 tubes of 5 mL	13500 rpm	192000 g	
	GJK004	32 microtubes of 0.2 mL (PCR)	14800 rpm	16200 g	
	GJK005	36 microtubes of 0.5 mL	14800 rpm	16200 g	

 = Accesories **included** with indicated item

 = Accesories **compatible** with indicated item

▶ GLC - Universal, bench top



▶ Model 2741, Medibas+

- 1| External case and base made of steel and inner chamber made of stainless steel.
- 2| LED displays for control and adjustment of the different centrifugation parameters: and a multifunctional single button to set all parameters.
- 3| Supplied complete with swing-out rotor and adapters for different type of tubes; both swing-out rotor and adapters are autoclavable.
- 4| Electromechanical lock to avoid opening the lid during operation and safety mechanism that avoids operation if the lid is open.
- 5| Maintenance-free induction motor.
- 6| Adapters code GBK003 are suitable for 5-7 mL tubes.



Code	GLC001
Capacity	4 x 100mL (100x40 mm) 8 x 50mL (Falcon type) 16 x 15mL (Falcon type)
Timer (min)	1-99 / shorts spin
Speed range (rpm)	100-4000
RCF max. (g)	2630 / 2720 / 2790
Rampas aceleración/frenado	9
Dimensions approx. (cm)	28x50x32
Weight approx. (Kg)	34,5

▶ GLF - Bench top, refrigerated



▶ Model 2850, Multifrig



- 1| External case made of high quality ABS plastic with base made of steel and large sucker feet .
- 2| Admite una amplia selección de cabezales angulares opcionales.
- 3| Large back-lit LCD display and a multifunctional single button to set all parameters.
- 4| Electromechanical lock con sistema de apertura manual.
- 5| Protection system that stops centrifugation in case of over speed and rotor imbalance. Over temperature protection system
- 6| Maintenance-free induction motor.







Code	GLF001
Timer	1h 59' 59" / Shorts spin
Speed range (rpm)	3000-18500 (steps of 100)*
Max. RCF	25330 g
Temperature range (°C)	-20 a +40
Pre-cooling function	Yes
Programs	10 memories
Acceleration rates	0-9 (< 35 from zero to max. speed)
Deceleration rates	0-9 (< 30 from max. speed to zero)
Dimensions approx. (cm)	61x52x37
Weight approx. (Kg)	55

* refer to rotor table

▶ GLH - Accessories



▶ CHART 5: 'Multifrig, refrigerated centrifuge accessories'

	Code	Description	Max. speed	RCF	Model Multifrig
	GLH001	12 microtubes of 1.5 - 2 mL	18500 rpm	25330 g	<input type="checkbox"/>
	GLH002	24 microtubes of 1.5 - 2 mL	16000 rpm	23210 g	<input type="checkbox"/>
	GLH003	36 microtubes of 0.5 mL	13500 rpm	13250 g	<input type="checkbox"/>
	GLH004	10 tubes of 5 mL	1600 rpm	18140 g	<input type="checkbox"/>
	GLH005	12 tubes of 50 mL	13000 rpm	15120 g	<input type="checkbox"/>
	GLH006	6 tubes of 50 mL	12000 rpm	13750 g	<input type="checkbox"/>
	GLH007	4 tubes of 100 mL	12000 rpm	14890 g	<input type="checkbox"/>

 = Accesories **included** with indicated item

= Accesories **compatible** with indicated item

▶ GNC - Sobremesa



▶ Modelo 2751 Multibas+

- 1| External case made of high quality ABS plastic with base made of steel .
- 2| Available different angle rotors (not included) with different capacity and for different type of tubes.
- 3| Large back-lit LCD display and a multifunctional single button to set all parameters.
- 4| Electromechanical lock to avoid opening the lid during operation and safety mechanism that avoids operation if the lid is open.
- 5| Maintenance-free induction motor.



Code	GNC001
Timer	1h 59' 59" / Short spin
Speed range (rpm)	100-5000*
RCF max. (g)	4980*
Programs	9 memories
Acceleration rates	0-9 (<35s from zero to max. speed)
Deceleration rates	0-9 (<30s from max. speed to zero)
Dimensions approx. (cm)	59x47x35
Weight approx. (Kg)	32







* Check rotors chart

page
[107]

▶ GNP - Accessories



▶ CHART 6: 'Adapters for Multibas+ centrifuge'



	Code	Description	Max. speed	RCF	Model Multibas+
	GNP001	Bottles with cap PP	-	-	<input type="checkbox"/>
	GNP002	Rotor for 4 bottles with cap of 250 mL	5000 rpm	2120 g	<input type="checkbox"/>
	GNP003	Adapter set for 4 plastic tubes of 100 mL	5000 rpm	4600 g	<input type="checkbox"/>
	GNP004	Adapter set for 4 tubes Falcon type of 50 mL	5000 rpm	4980 g	<input type="checkbox"/>
	GNP005	Adapter set for 8 tubes Falcon type of 50 mL	4000 rpm	3040 g	<input type="checkbox"/>
	GNP006	Adapter set for 24 tubes Falcon type of 15 mL	4000 rpm	3040 g	<input type="checkbox"/>
	GNP007	Adapter set for 32 tubes Falcon type of 15 mL	4000 rpm	3040 g	<input type="checkbox"/>

= Accessories **included** with indicated item

= Accessories **compatible** with indicated item



▶ CHART 6: 'Adapters for Multibas+ centrifuge'

	Code	Descripción	Max. speed	RCF	Model Multibas+
	GNP008	Adapter set for 48 tubes for blood extraction 7 mL Dimensions 13x100 mm	4000 rpm	3040 g	<input type="checkbox"/>
	GNP009	Adapter set for 72 tubes for blood extraction 7 mL Dimensions 12x75 mm	4000 rpm	3040 g	<input type="checkbox"/>
	GNP010	Swing-out rotor 4 microtiter plates	3500 rpm	2120 g	<input type="checkbox"/>

i = Accesories **included** with indicated item

= Accesories **compatible** with indicated item



[H] INDEX OF CONTENTS OPTICAL EQUIPMENTS

[HB] Microscopes	110	[HJ] Spectrophotometers	127
HBB - Education	110	HJB - Visible.....	127
HBC - Professional	111	HJD - UV/Visible	128
HBD - Digital	113	HJG - Checking standards	131
HBF - Fluorescence	114	HJH - Accessories	132
HBG - Polarization	115	HJK - Cells, glass	133
HBH - Metallurgical	116	HJL - Cells, quartz.....	135
HBJ - Inverted biological	117	HJM - Cells, others	136
HBK - Operation	118	[HM] Polarimeters	137
HBL - Accessories, condensers	120	HMB - Polarimeters	137
HBM - Accessories, phase contrast	120	HMF - Polarimeters, Calibration pieces	138
HBN - Accessories, polarization	120	HMG - Accessories	138
HBP - Accessories, objectives	121	[HP] Refractometers	139
HBQ - Accessories, eyepieces	121	HPB - Abbe	139
HBR - Accessories, others	121	HPD - Hand, Brix scale	139
[HD] Stereomicroscopes	122	HPF - Hand, salinity	142
HDB - Education	122	HPH - Hand, oenology	143
HDD - With zoom.....	123	HPK - Hand, batteries.....	144
HDG - Accessories, objectives	125	HPM - Hand, clinical	145
HDH - Accessories, eyepieces	125	HPP - Hand, others	145
HDJ - Accessories, supports	125	[HR] Magnifying glasses	148
HDK - Accessories, others	126	HRB - Hand.....	148
[HG] Videocameras	126	HRD - Table.....	148
HGD - Videocameras C-mount	126	HRG - Thread counters	148

TRADEMARKS:



 HBB - Education

 Series 116

- 1| Monocular microscope with LED illumination. Operation with adapter (included) or with batteries
- 2| Monocular head inclined 45° and rotary 360°.
- 3| Coaxial coarse and fine focusing knobs .
- 4| Fix condenser with single with iris diaphragm and filter holder.

Code	HBB003
Model	116
Head	Monocular inclined 45° and rotary 360°
Eyepieces	WF10x/18 mm (Ø 23 mm)
Diopter correction	No
Nosepiece	Triple
Objectives	Achromatic 4x (NA:0,10) 10x (NA:0,25) 40x (R) (NA:0,65)
Stage	110 x 110 mm (clamps)
Focus	Coaxial knobs
Condenser	Fix single lens (A.N.: 0,65)
Diaphragm	Iris
Filter holde / Filters	Blue (Ø 32 mm)
Illumination	LED diode (adjustable)
Power	Adaptor (220V, 50/60Hz) Batteries 3x1,5V (AA)

 Serie 'E'

- 1| Available with monocular (model M-HB10) and binocular head (model B-HB11). The head is 30° inclined and 360° rotary. Binocular model presents interpupillary distance regulation and diopter adjustment in one of the eyepieces.
- 2| The eyepieces are provided with fixing screws to avoid being removed from the eyepiece tube..
- 3| Quadruple inverted nosepiece to make changing the sample easier and more comfortable..
- 4| Double layer mechanical stage with coaxial translation knobs; the microscope is equipped with a safety screw to fix the maximum upper position of the stage and avoid it to hit and damage the objectives.
- 5| Built-in rechargeable batteries that allows a cordless operation.

Code	HBB010	HBB011
Model	M-HB10	B-HB11
Head	Monocular	Binocular
	Siedentopf type; inclined 30° and rotary 360° Interpupillary distance adjustable (55-75mm)	
Eyepieces	WF10x/18 mm	
Nosepiece	Quadruple inverted	
Objectives	Achromatic objectives: 4X, 10X, 40X (R), 100X (R) (I)	
Stage	Double layer mechanical stage, size 115x 125 mm , movement 75x50mm	
Condenser	Abbe (NA 1.25) with iris diaphragm and filter holder	
Focus	Coarse and fine focusing coaxial knobs. Focusing scale 0.002mm	
Illumination	LED 3W/4V, adjustable intensity	
Power	100-240V; 50-60Hz Rechargeable batteries 3x NiMH AA1400mAH 1.2V	

▶ HBC - Professionales

▶ Serie 100



- 1| Useful and robust microscopes available in different models to cover a wide range of applications.
- 2| Head inclined 45° and rotary 360° with interpupilar distance adjustment and diopter correction
- 3| Coaxial coarse and fine focusing knobs with tension adjustment ring and focus upper limit locking device.
- 4| Double layer mechanical stage with clamp to hold up to 2 slides.

Code	HBC002
Model	107
Head	Binocular
Eyepieces	WF10x/18 mm (Ø23 mm) + WF16x/11mm (Ø23 mm)
Interpupillary dist.	53-72 mm
Diopter correction	±2 diopters (one or both)
Nosepiece	Quadruple
Objectives	Achromatic 4x (NA:0.10) 10x (NA:0.25) 40x (R) (NA:0.65) 100x (R)(I)(NA:1.25)
Stage	130 x 140 mm double layer mechanical
Condenser	Abbe (AN: 1.25)
Diaphragm	Iris
Filters	Blue and Green (Ø 32 mm)
Lamp	LED
Power	100-240V, 50/60 Hz



page
[111]

▶ Serie 'P'



- 1| Available with binocular (model B-HC15) and trinocular (model T-HC16) Siedentopf head, 30° inclined and 360° rotary. They are provided with diopter correction adjustment in both eyepieces and regulation of the interpupillary distance.
- 2| Quadruple inverted nosepiece to make changing the sample easier and more comfortable.
- 3| Double layer mechanical stage with coaxial translation knobs and a clamp to hold up to 2 slides at the same time; the microscope is equipped with a safety screw to fix the maximum upper position of the stage and avoid it to hit and damage the objectives.
- 4| Coarse and fine focusing coaxial knobs at an ergonomic position and equipped with tension adjustment ring.
- 5| Built-in rechargeable batteries that allows a cordless operation.

Code	HBC015	HBC016
Model	B-HC15	T-HC16
Head	Binocular	Trinocular
	Siedentopf type; inclined 30° and rotary 360° Interpupillary distance adjustment (55-75mm)	
Eyepieces	WF10x/18 mm	
Nosepiece	Quadruple inverted	
Objectives	Achromatic objectives: 4X, 10X, 40X (R), 100X (R) (I).	
Stage	Double layer mechanical stage, size 132x 142 mm , movement 75x50mm	
Condenser	Abbe (NA 1.25) with iris diaphragm and filter holder	
Focusing	Coarse and fine focusing coaxial knobs. Focusing scale 0.002 mm	
Illumination	LED 3W/4V, adjustable intensity	
Power	100-240V; 50-60Hz	
	Rechargeable batteries 3x NiMH AA1400mAH 1.2V	



▶ HBC - Professional

▶ Serie 100



Mod. HBC007



- 1 | Coobservation professional microscopes.
- 2 | Stage double layer mechanical

Code	HBC007	HBC006
Model	204	155
Head	2 Bineyepieces 45° 360°	5 Bineyepieces 45° 360°
Eyepieces	WF10x/18 mm	WF10x/18 mm*
Nosepiece	Quadruple	Quadruple
Objectives	Achromatic 4x (NA:0.10) 10x (NA:0.25) 40x (R) (NA:0.65) 100x (R)(I)(NA:1.25)	Achromatic 4x (NA:0.10) 10x (NA:0.25) 40x (R) (NA:0.65) 100x (R) (I) (NA:1.25)
Stage	140x140 mm	130x140 mm
Focus	Coaxial knobs	Coaxial knobs
Condenser	Abbe (AN:1,25)	Abbe (AN:1,25)
Diaphragm	Iris	Iris
Filters	Blue and Green (Ø 32 mm)	Blue and Green (Ø 32 mm)
Lamp	Halogen (6V, 20W)	Halogen (24V, 100W)
Power	220V, 50Hz	220V, 50Hz

* bright pointer

▶ Serie 122



Mod. HBC010



Mod. HBC011



- 1 | Siedentopf-type binocular head, rotary in 360° and 30° inclined .
- 2 | Wide mechanical stage (180x150 mm) that can be moved around 75(X) x 50(Y) mm and presents scales along both axes for an easier localization of structures of interest.
- 3 | Coaxial knobs at both sides of the stative for coarse and fine focusing adjustment. The knobs are provided with a friction control ring and with a focusing upper limit blocking lever
- 4 | Köhler illumination system for a higher control of illumination thanks to the presence of graduated diaphragms.
- 5 | Replacing the lamp is also easy and trouble-free.

Code	HBC008	HBC009	HBC010	HBC011
Model	122/107	122/108	122/147	122/148
Head	Binocular	Trinocular	Binocular	Trinocular
Eyepieces	WF10x/18mm (Ø23mm) WF16x/11mm (Ø23mm)		WF10x/20mm (Ø30mm)	
Interpupillary dist.	55-75mm			
Diopter correction	± 5 diopters (left eyepiece)			
Nosepiece	Quadruple inverted			
Objectives	Achromatic 4x (NA:0,10) 10x (NA:0,25) 40x (R) (NA:0,65) 100x (R) (I) (NA:1,25)		Plano achromatic infinity corrected 4x, ∞ (NA:0,10) 10x, ∞ (NA:0,25) 40x, ∞ (R) (NA:0,65) 100x, ∞ (R) (I) (NA:1,25)	
Stage	180 x 150mm double layer mechanical			
Illumination	Köhler			
Condenser	Abbe (AN: 1,25)			
Diaphragm	Field and aperture			
Filters	Blue and Green (Ø 32 mm)			
Lamp	Halogen	LED	LED	LED
Power	85V-240V/50-60Hz			

▶ HBC - Professional

▶ Serie 158



- 1| The highest features and some ergonomic and sturdiness characteristics that make them especially suitable for daily work in research laboratories.
- 2| Quintuple inverted nosepiece with plan achromatic objectives.
- 3| Double layer mechanical stage of large dimensions (160x180 mm).
- 4| Coaxial knobs at both sides of the stative for coarse and fine focusing adjustment. The knobs are provided with a friction control ring and with a focusing upper limit blocking lever.
- 5| Köhler illumination system with field and aperture diaphragms.
- 6| Abbe condenser with a swing-out upper lens.
- 7| Lamp placed in accesible comparmnt with centering knobs.

Code	HBC013	HBC014
Model	158/7	158/8
Head	Siedentopf type, 0-40° (adjustable) 360°	
	Binocular	Trinocular
Eyepieces	WF10x/22mm (Ø30mm)	
Interpupillary dist.	55-75mm	
Diopter correction	±5 diopters (left eyepiece)	
Nosepiece	Quintuple inverted	
Objectives	Plano achromatic infinity corrected 4x, ∞ (NA:0,10); 10x, ∞ (NA:0,25) 20x, ∞ (NA:0,40); 40x, ∞ (R) (NA:0,65) 100x, ∞ (R) (I) (NA:1,25)	
Stage	160 x 180 mm double layer mechanical	
Diaphragm	Field and aperture	
Filters	Blue, Green and Yellow (Ø 32 mm)	
Lamp	Halogen (12V, 50W)	
Power	110V-220V/ 50-60 Hz	

Mod. HBC013



Mod. HBC014

page
[113]

▶ HBD - Digital

▶ Serie 135



- 1| Available monocular and binocular models.
- 2| Mechanical stage with traslation knobs and with graduated scale both sides.
- 3| Coaxial coarse and fine focusingknobs to operate easier and faster. Provided with tension ring and focusing upper limit blocking lever.
- 4| Includes TSView.

Code	HBD001	HBD002
Model	135/6	135/7
Head	Monocular	Binocular
	30° 360°	
Interpupillary dist.	- 55-75mm	
Diopter correction	-	left eyepiece
Eyepieces	WF10x/18 mm (Ø23 mm)	
Nosepiece	Quadruple (1 free)	
Objectives	Achromatic 4x (NA:0,10); 10x (NA:0,25); 40x (R) (NA:0,65)	
Stage	140 x 140 mm double layer mechanical	
Focus	Coaxial fine and coarse	
Condenser	Abbe (AN: 1,25)	
Diaphragm	Iris	
Filters	Blue, Green and Yellow (Ø 32 mm)	
Lamp	LED diode (Adjustable)	
Power	100-240V, 50/60Hz	
Camera	1,3 Mp, 1280 x 1024 pixeles	
Output	USB 2.0, Software TS View	

Mod. HBD001



Mod. HBD002



▶ HBD - Digital

▶ Serie 148



- 1| Siedentopf-type binocular head, 30° inclined with interpupillary distance adjustment and diopter correction.
- 2| Inverted quadruple nosepiece for handling the slides more easily.
- 3| Large dimension mechanical stage (180x150 mm).
- 4| Coaxial fine and coarse focusing knobs. Provided with tension ring and focusing upper limit blocking lever. Fine focusing knobs are graduated.
- 5| Köhler illumination system with Field and aperture diaphragms and height-adjustable Abbe condenser.
- 6| Includes TSView .

Code	HBD003
Model	148/7
Head	Binocular
Interpupillary dist.	55 - 75 mm
Diopter correction	left eyepiece
Eyepieces	WF10x/22 mm (Ø30 mm)
Nosepiece	Quadruple inverted
Objectives	Achromatic 4x (NA:0,10) - 10x (NA:0,25) 40x (R) (NA:0,65) - 100x (R) (I) (NA:1,25)
Stage	180 x 150 mm double layer mechanical
Focus	Coaxial fine and coarse
Condenser	Abbe (AN: 1,25)
Diaphragm	Field and aperture (Köhler type)
Filters	Blue, Green and Yellow (Ø 32 mm)
Lamp	LED diode 1W (Adjustable)
Power	100-240V, 50/60Hz
Camera	3,0 Mp, 2048 x 1536 pixeles
Output	USB 2.0, Software TS View

▶ HBF - Fluorescence

▶ Epi-fluorescence microscope



- 1| Broad and solid base that provides great stability.
- 2| Inclined head 45° , interpupillary adjustment and diopter correction.
- 3| Sixdruple nosepiece with 4 plane achromatic objectives with infinity corrected optical, specially designed for fluorescence applications.
- 4| Turret with different interchangeable positions to select excitation filter of cube and emission of wavelength more appropriate for the used .
- 5| Köehler system for transmitted lighting with field diaphragms and opening and Abbe condenser with sliding lens of the optical way.
- 6| Mercury high pressure lamp of 100W for fluorecence through reflected light; housed in a separate compartment and with centering screws.

Code	HBF001
Model	158/358
Head	Trinocular; 360°
Interpupillary dist.	50-75 mm with diopter correction
Nosepiece	Séxtuple
Objectives	Plano apo-achromatic Infinity correcte 4x, ∞ (A.N.: 0,15) - 10x, ∞ (A.N.: 0,35) 40x, ∞ (R) (A.N.: 0,75) - 100x, ∞ (R) (A.N.: 0,90)
Stage	180x160 mm / double layer mechanical (80x50 mm)
Illumination	Köhler type, diaphragm Field and aperture
Condenser	Abbe (AN: 1,25) slideable
Lamp	
Epi-fluorescence	Mercury high pressure lamp 20V, 100W
Transmitted	Halogen lamp 12V, 50W (adjustable)
Power	100-240V, 50/60Hz

▶ HBG - Polarization

▶ Polarizing microscope, model 146 P

- 1| Rotary and circular stage, 160 mm diameter and a graduation from 0° to 360° with Vernier, resolution of 0.1° and mechanism to fix the stage position.
- 2| Siedentopf binocular head inclined 30°.
- 3| With rotary and graduated polarized and analyzer filter.
- 4| Bertrand lens sliding from the optical path for conoscopic observations and crack for the insertion of compensative plaques. Supplied with gypsum (1 λ), mica (1/4 λ) and quartz wedges.
- 5| Quadruple nosepiece with plan achromatic objectives.
- 6| Köhler illumination system with field.

Code	HBG001
Model	146P
Head	Binocular - Siedentopf type
Eyepieces	2uds WF10x/22mm (Ø30mm) 1ud WF10x/20mm graduated (Ø30mm)
Interpupillary dist.	Yes
Diopter correction	Left eyepiece
Nosepiece	Quadruple
Objectives	Plan achromatic, Infinity correcte 4x, ∞ (NA:0,10) - 10x, ∞ (NA:0,25) 40x, ∞ (R) (NA:0,65) - 60x, ∞ (R) (NA:0,85)
Polarizer	Rotary 360°
Analyzer	Rotary 90° (Vernier graduated)
Bertrand Lens	Sliding from the optical path
Supplementary wedges	gypsum (1 λ), mica (1/4 λ) and quartz
Stage	Circular (160mm) and rotary 360°
Illumination	Köhler type
Condenser	Abbe (AN: 1,25)
Diaphragm	Field and aperture
Lamp	Halogen (6V, 20W)
Power	100V-240V/50-60 Hz



▶ Polarizing microscope 501

- 1| Monocular head inclined 30°
- 2| Rotary and circular stage, 160 mm diameter and a graduation from 0° to 360° with Vernier, resolution of 0.1° and mechanism fix the sage position.
- 3| With rotary and graduated polarized and analyzer filter.
- 4| Bertrand lens sliding from the optical path for conoscopic observations and crack for the insertion of compensative plaques. Supplied with gypsum (1 λ), mica (1/4 λ) and quartz wedges.
- 5| Height adjustable Abbe condenser with iris diaphragm.

Code	HBG002
Model	501
Head	Monocular
Eyepieces	WF10x/20mm (Ø23mm)
Interpupillary dist.	Yes
Diopter correction	Left eyepiece
Nosepiece	Quadruple
Objectives	Achromatic 4x (NA:0,10) - 10x (NA:0,25) - 40x (R) (NA:0,65)
Polarizer	Rotary 360°
Analyzer	Rotary 90° (Vernier graduated)
Lens Bertrand	Sliding from the optical path
Supplementary wedges	gypsum (1 λ), mica (1/4 λ) and quartz
Stage	Circular (160mm) and rotary 360°
Illumination	Köhler type
Condenser	Abbe (AN: 1,25)
Diaphragm	Iris
Lamp	Halogen (12V, 30W)
Power	85-230V, 50/60Hz



▶ HBH - Metallurgical

▶ Metallurgical



- 1 | Very robust and large equipment with a high stability and a wide range of applications.
- 2 | 30° inclined trinocular Siedentopf-Type head with interpupillary distance adjustment and diopter correction.
- 3 | Three layer mechanical stage, very large (250x230 mm) and with a movement of 154 mm. Provided with a third layer for quick movements.
- 4 | Köhler illumination system with field and aperture diaphragms.
- 5 | Filter holder with green, yellow, blue and matt glass to get a high image quality.
- 6 | Equipped with analyzer and polarizer that can be removed from the optical path.
- 7 | The lamp is provided with a centering mechanism to get a correct adjustment.

Code	HBH004
Model	101
Head	Trinocular Siedentopf type, 30°
Eyepieces	WF10x/22 mm wide field (Ø23 mm)
Interpupillary dist.	55-75 mm
Diopter correction	± 5 diopter compensation in left eyepiece holder
Revolver	Quintuple Rotary 360°
Objectives	Plan Achromatic 5x (A.N.: 0,12) - 10x (A.N.: 0,25) 20x (A.N.: 0,40) - 40x (R) (A.N.: 0,60) - 80x (R) (I) (A.N.: 0,80)
Stage	250 x 230 mm three layer mechanical (154 x 154 mm)
Illumination	Köhler type
Condenser	Abbe (A.N.: 1,25) adjustable
Diaphragm	Field and aperture
Filters	Mate, blue, green and yellow
Lamp	Halogen 6V, 20W
Polarizing system	Polarizer and analyzer can be removed from the light path
Power	110-220V, 50/60 Hz

▶ Metallurgical microscope



- 1 | Trinocular head type Siedentopf.
- 2 | Quadruple nosepiece with plan achromatic objectives, infinity corrected optics.
- 3 | Reflected or transmitted light:

Reflected light system: halogen lamp with regulator of intensity, field and aperture diaphragms and filter-holder that includes green, yellow and blue filters. With polarizer and analyzer rotary in 360° that can be removed from the light path.

Transmitted light system: halogen lamp with Abbe condenser (N.A.: 1.25) field and aperture diaphragms and mobile filter holder that includes green, blue and yellow filters.

Code	HBH005
Model	146 M
Head	Trinocular Siedentopf type, inclined 30° and rotary 360°
Eyepieces	2 uds WF10x/22 mm (Ø23 mm) 1 ud WF10x/20 mm with 0,1 mm reticle
Interpupillary dist.	55-75 mm
Diopter correction	± 5 diopters in left eyepiece holder
Revolver	Quadruple
Objectives	Plano achromatic infinity corrected 4x, ∞ (A.N.: 0,10) - 10x, ∞ (A.N.: 0,25) 20x, ∞ (A.N.: 0,40) - 40x, ∞ (R) (A.N.: 0,65)
Stage	160 x 180 Double layer mechanical
Reflected illumination	
Lamp	Halogen 12 V, 30 W
Diaphragms	Field and aperture
Filter holde	Rotary; green, blue and yellow filters and polarizer filter
Polarizing system	Polarizer in filter holder and analyzer rotary 360°
Transmitted illumination	
Lamp	Halogen 12 V, 30 W
Diaphragms	Field diaphragm in precondenser and graduated aperture diaphragm
Condenser	Abbe (A.N. 1.25); adjustable height
Filter holde	Mobile; filters green, blue and yellow
Power	85-220V, 50/60 Hz

▶ HBH - Metallurgical

▶ Metalográfico invertido, model 403



- 1| High features metallurgical microscope. With inverted design, infinity corrected optics and incident light.
- 2| 45° inclined trinocular head.
- 3| Fixed stage with movable platform for sample movement.
- 4| Quadruple nosepiece with plan achromatic objectives that provides with infinity corrected optics.
- 5| Köhler illumination system with field and aperture diaphragms.
- 6| Equipped with polarizing filter and rotary and graduated analyzer.

Code	HBH006
Model	403
Head	Trinocular; Siedentopf; inclined 45°
Eyepieces	WF10x/22 mm gran campo Ø 23 mm
D. Interpupillary dist.	50-75 mm
Diopter correction	Right
Nosepiece	Quadruple
Objectives	Plano achromatic infinity corrected 4x, ∞ (A.N.: 0,10) - 10x, ∞ (A.N.: 0,25) 20x, ∞ (A.N.:0,40) - 40x, ∞ (A.N.:0,65)
Stage	Fija 242 x 172 mm with movable platform 128x186 mm
Illumination	Epi-Köhler
Condenser	Abbe slideable
Diaphragm	Field and aperture
Filters	Blue, green and yellow
Lamp	12V 30W
Power	85-220V, 50/60Hz



page
[117]

▶ HBJ - Inverted biological

▶ Serie 180



- 1| Inclined head with interpupillary distance adjustment and diopter correction.
- 2| Quadruple nosepiece with plan achromatic objectives. With 10x long distance objective for phase contrast.
- 3| Long distance condenser, centrable and adjustable with iris diaphragm and filter holder.
- 4| Large rectangular stage.

Code	HBJ001	HBJ002
Model	181	182
Head	Trinocular, 30°	Binocular, 45°
Eyepieces	WF10x/18mm (Ø23mm)	WF10x/20mm (Ø23mm)
Interpupillary dist.	55-75mm	55-75mm
Diopter correction	± 5 diopters (left eyepiece)	
Nosepiece	Quadruple	
Objectives	Plan achromatic long distance 10x (A.N.: 0,25) phase contrast 10x (A.N.: 0,25) 25x (A.N.: 0,40) 40x (R) (A.N.: 0,65)	Plan achromatic long distance 25x (A.N.: 0,40) phase contrast 10x (A.N.: 0,25) 25x (A.N.: 0,40) 40x (R) (A.N.: 0,65)
Stage	200 x 150 mm Movement 70x30 mm	180x155 mm Movement 75x50 mm
Condenser	Long distance with diaphragm and filter holder	
Diaphragm	Field	Iris
Filter	Blue, yellow, green and neutral	
Lamp	Halogen (6V, 20W) adjustable intensity	
Power	220V/50 Hz	



Code HBJ001

▶ HBK - Operation

▶ Serie 191



- 1 | Long distance pantographic arm to move the head of the microscope up and down; it is provided with fixation screws to hold the head at the desired position .
- 2 | Star shaped base with 5 wheels and brake to easily move the microscope and fix it at the adequate place.
- 3 | The head is provided with 3 magnification positions easily interchangeable .
- 4 | Model 191/120 is supplied with C-mount for attaching a video camera and thus allowing visualization through a computer or monitor.
- 5 | Illumination system: Coaxial illumination with cold light source and fiber optic cable

Code	HBK001	HBK002	HBK003
Model	191/101	191/102	191/120
Head	Straight	Inclined 45°	Straight
Magnification of observation	6x	6x	6x
Magnification changer	3 positions: 0.6x, 1x, 1.6x		
Total magnification	3x-12x		
Diopter adjustment	+/-5D		
Interpupillary distance	52-78 mm		
Beamsplitter	No	No	50:50
Coobservation tube	No	No	Optional
Video adapter	No	No	Rosca C
Fine focusing range	10 mm		
Filter	Built-in green and yellow filters		
Illumination system	Coaxial illumination with cold light source and fiber optic cable		
Halogen lamp	21V, 150W; adjustable intensity		
Fiber-optic cable	1600 mm	1600 mm	1700 mm
Power	110/220 V, 50/60 Hz		
Potency output	<200W		

▶ Chart of magnification and field of view

NOMINAL VALUE

Objectives	F=200 mm			F=250* mm			F=300 mm			F=400* mm		
	1.6x	1x	0.6x	1.6x	1x	0.6x	1.6x	1x	0.6x	1.6x	1x	0.6x
Magnification changer position	12x	7.5x	4.7x	9.6x	6x	3.7x	8x	5x	3x	6x	3.8x	2.3x
Total magnification	15.8	25.3	40.6	19.7	31.6	50.7	23.6	37.9	60.8	31.5	50.5	81
Field of view (mm)	1.04	1.66	1.04	1.66	1.04	1.66	1.04	1.66				
Exit pupil diameter (mm)	15.3			15.3			15.3			15.3		
Exit pupil distance (mm)	67	44.5	29.7	60	35.4	27	47.2	31.5	23.6	35	27	19.8
Resolution (LP/mm)												

* optional

▶ HBK - Operation

▶ Colposcope Model 192/2



- 1 | Long distance pantographic arm to move the head of the microscope up and down; it is provided with fixation screws to hold the head at the desired position. .
- 2 | Star shaped base with 5 wheels and brake to easily move the microscope and fix it at the adequate place.
- 3 | The head is provided with 5 magnification positions easily interchangeable by turning the corresponding knob; see chart of magnification and field of view for more information.
- 4 | Supplied with C-mount for attaching a video camera and thus allowing visualization through a computer or monitor.



Code	HBK004
Model	192/2
Head	Binocular straight
Eyeieces	WF16x (dioptr correction)
Magnification changer	5 positions (0,4x 0,66x, 1x, 1,5x y 2,5x)
Total magnification	Min 2,9x y máx. 21,7x
Working distance	230 mm y 280 mm
Lamp	Coaxial illumination, halogen lamp 15 V, 150 W
Diameter beam	60 mm
Filters	Blue and green
Power	110-220V, 50Hz

Objectives	Objectives I f' = 230					Objectives II f' = 280 mm				
	Zoom	2,5 x	1,5 x	1,0 x	0,66 x	0,4 x	2,5 x	1,5 x	1,0 x	0,66 x
Magnification	21,7x	13,2x	8,7x	5,7x	3,5x	17,8x	10,8x	7,1x	4,7x	2,9x
Field Ø	11,0	18,2	27,6	42,1	69,0	13,4	22,0	33,6	51,1	84,0
Resolution	86,0	68,0	52,0	35,0	27,0	80,0	63,0	42,0	31,0	22,3

▶ Motorized Model 195







- 1 | Fine focusing motorized system, by foot control switch with 2 switches for moving the head up or down.
- 2 | Long distance pantographic arm to move the head of the microscope up and down; it is provided with fixation screws to hold the head at the desired position.
- 3 | The head is provided with 3 magnification positions easily interchangeable.
- 4 | H-shaped base with 4 wheels and brake to easily move the microscope and fix it at the adequate place.



Code	HBK005
Model	195
Head	Binocular inclined 45°
Eyeieces	12.5x16B (wide field)
Objective lens	f=200 mm
Working distance	190 mm
Magnification	5.3x, 8x, 12x
Field diameter	37 mm, 25 mm, 16.7 mm
Dioptr correction	± 6 D
Interpupillary distance	50-80 mm
Max. resolution	100 LP/mm
Coaxial illumination	≥30000lx con with cold light and fiber optic cable
Reflective lamp	12V, 100W
Reaching radius of arm	870 mm
Vertical adjustment range	700-1100 mm
Fine focusing range	30 mm
Voltage	AC220V±22V / 50Hz±1Hz

▶ HBL - Accessories, condensers

▶ CHART 1: 'accessories condensers 100 y 122'



	Code	Capacity	Model	
			100	122
	HBL001	Abbe Condenser, 1,25 A.N.	<input type="checkbox"/>	
	HBL002	Dry dark field condenser Numerical aperture 0,9		<input type="checkbox"/>
	HBL003	Immersion dark field condenser Numerical aperture 1,25		<input type="checkbox"/>
	HBL004	Dark field condenser dry Numerical aperture 0,9	<input type="checkbox"/>	
	HBL005	Dark Field Condenser Oil immersion Numerical aperture 1,25	<input type="checkbox"/>	

 =Accessories included with indicated item

=Accessories compatible with indicated item

▶ HBM - Accessories, phase contrast

▶ CHART 2: 'accessories phase contrast 122/107, 122/108, 122/147, 122/148 and 158'



	Code	Description	Model				
			122/107	122/108	122/147	122/148	158
	HBM001	Single annular phase contrast Kit Achromatic objectives 10x, 40x (R), 100x (R) (I). Centring eyepiece (Ø 23 mm)	<input type="checkbox"/>	<input type="checkbox"/>			
	HBM002	Turret phase contrast equipment Plan achromatic objective 4x, 10x, 40x (R) 100x (R) (I). Centring eyepiece (Ø 30 mm)			<input type="checkbox"/>	<input type="checkbox"/>	<input type="checkbox"/>

 =Accessories included with indicated item

=Accessories compatible with indicated item

▶ HBN - Accessories, polarization

▶ CHART 3: 'polarization 100 and 122'

	Code	Capacity	Model	
			100	122
	HBN001	Basic polarization set Filter analyzer: Ø 23 mm Filter polarizer: Ø 55 mm	<input type="checkbox"/>	
	HBN003	EqBasic polarization set Filter analyzer: Ø 18 mm Filter polarizer: Ø 55 mm		<input type="checkbox"/>

 =Accessories included with indicated item

=Accessories compatible with indicated item

▶ HBP - Accessories objectives

Code	Description
HBP001	Achromatic objectives 4x Numerical aperture (A.N.) 0.10
HBP002	Achromatic objectives 10X Numerical aperture (A.N.) 0.25
HBP003	Achromatic objectives 20X Numerical aperture (A.N.) 0.40
HBP004	Achromatic objectives 40x (R) Numerical aperture (A.N.) 0.65
HBP005	Achromatic objectives 60x (R) Numerical aperture (A.N.) 0.85
HBP006	Achromatic objectives 100x (R) (I) Numerical aperture (A.N.) 1.25
HBP007	Plan achromatic objectives 4x Numerical aperture (A.N.) 0.10
HBP008	Plan achromatic objectives 10x Numerical aperture (A.N.) 0.25
HBP009	Plan achromatic objectives 20x Numerical aperture (A.N.) 0.40
HBP010	Plan achromatic objectives 40x (R) Numerical aperture (A.N.) 0.65
HBP011	Plan achromatic objectives 100x (R) (I) Numerical aperture (A.N.) 1.25
HBP012	Semi-plan achromatic objectives 4x
HBP013	Semi-plan achromatic objectives 10X
HBP014	Semi-plan achromatic objectives .40x/R
HBP015	Semi-plan achromatic objectives. 100X R/I
HBP016	Fluorescence plan apo-chromatic objective, 20x (R). Numerical aperture (A.N.) 0.25
HBP017	Achromatic objectives 4x for series 170
HBP018	Achromatic objectives 10x for series 170
HBP019	Achromatic objectives 20x for series 170
HBP020	Achromatic objectives 40x for series 170
HBP021	Achromatic objectives 100x for series 170
HBP022	Achromatic Objective 4x. Short Numerical aperture (A.N.) 0.10
HBP023	Achromatic Objective 10x. Short Numerical aperture (A.N.) 0.25
HBP024	Achromatic Objective 40x (R) Short Numerical aperture (A.N.) 0.65
HBP025	Achromatic Objective 100x (R) (I) Short Numerical aperture (A.N.) 1.25
HBP026	Objectives F250, for series 191
HBP027	Objectives F400, for series 191

▶ HBQ - Accessories, eyepieces

Code	Description
HBQ001	Wide field eyepiece WF 10x/18 mm. Diameter 23 mm
HBQ002	Wide field eyepiece WF16x/11 mm. Diameter 23 mm
HBQ003	Wide field eyepiece WF10x point for Microscope 100. Diameter 23 mm
HBQ004	Wide Field eyepiece WF 10x/18 mm with 0,1 micrometer Diameter 23 mm
HBQ005	Photographic eyepiece 4x. Diameter 23 mm
HBQ006	Extra wide field eyepiece WF10x/21 mm. Diameter 23 mm
HBQ007	High point eyepiece WF10x/18,5 mm. Diameter 23 mm
HBQ008	Eyepiece WF10x/22 mm. Diameter 30mm
HBQ009	Eyepiece WF16x. Diameter 30 mm
HBQ010	Micrometric eyepiece WF10x/22 mm. Diameter 30 mm

▶ HBR - Accessories, others

▶ Stages

Code	Description
HBR010	Heating stage for series 100 / 122. Range of temperature adjustable: T ^a environmental - 50 °C
HBR014	Mechanical stage for series 128 / 116 / 119

▶ Video photography

Code	Description
HBR006	Photographic attachment T mount
HBR007	Video Attachment without lens (C-lens)
HBR018	Photography Attachment with viewfinder for 170
HBR019	Video attachment C mount for model 170 (Metallurgical)

HBR - Accessories, others

Condenser, diaphragm, illumination

Code	Description
HBR004	Diaphragm iris for series 100
HBR005	Halogen lamp 6V, 20W
HBR008	Filter for green condenser (Ø 32 mm) for models 116/128/119/100/122/158
HBR009	Filter for blue condenser (Ø 32 mm) for models 116/128/119/100/122/158
HBR012	Halogen lamp 6V, 15W
HBR015	Epi-fluorescence lamp
HBR016	Halogen lamp 24V, 100W
HBR017	Halogen lamp 12V, 50W
HBR021	Dicroic halogen lamp 15V 150W

For operation microscopes

Code	Description
HBR022	Wall stand for model 191
HBR023	Table stand for model 191
HBR024	Coobservation monocular tube for models 191/120

Others

Code	Description
HBR002	Lens tissues 110x85 mm, b/50
HBR003	Microscope cleaning kit
HBR011	Plastic dust cover for professional microscopes
HBR013	AC/DC adapter 230V/5.5V 200mA for microscope 116
HBR020	Dust cover inverted microscope

HDB - Education

Serie 200



Code: HDB004

- 1 | Use in teaching for the mineral or little animal observation.
- 2 | Binocular head with adjustable interpupillary distance and dioptic correction.
- 3 | Bilateral controls for focusing through rack and pinion mechanism.
- 4 | Black and white contrast stage and ground glass stage.

Code	HDB002	HDB004
Model	218/2	220
Head	Binocular	Binocular
	45° 360°	45° 360°
Eyepieces	WF10x/20mm	WF10x/18mm
interpupillary distance	55-75mm	
Diopter correction	± 5 mm diopters	
Nosepiece	Quadruple	Quadruple
Objectives	2x/4x	2x/4x
Working distance	60 mm	76 mm
Stage	B/N ground glass with clamps (95) mm	
Illumination	Incident and transmitted*	
Power	220V, 50/60Hz	

* adjustable code HDB004

▶ HDD - Zoom

▶ Series 234



- 1| To be used in industrial or research laboratories.
- 2| Head inclined 45° and rotary 360°.
- 3| Rod-type support to adjust height of head (max. 200 mm).
- 4| Incident and transmitted light with independent or joined regulation (3 positions)

Code	HDD006
Model	235
Head	Trinocular 45° 360°
Interpupillary distance	55-75 mm
Dipoter correction	± 5 diopters
Eyepieces	WF 10x-20 mm
Objectives	1x
Zoom	1x a 4x (coaxial knobs)
Zoom ratio	4
Working distance	85 mm
Stage	Black and white ground glass (95 mm) with clamps
Filter	Blue (40 mm)
Illumination	Incident (12V/10W) and transmitted (12V/10W)
Power	100-240V, 50/60Hz



Chart of magnification Mod. 235

Zoom	Objectives	Eyepiece WF10X		Eyepiece WF15X		Eyepiece WF20x	
		Magnification	field Ø (mm)	Magnification	field Ø (mm)	Magnification	field Ø (mm)
1x-4x	1.0x	10x - 40x	23 - 5.5	15x - 60x	15.5 - 4	20x - 80x	10.5 - 3
	0.5x	5x - 20x	52 - 12	7.5x - 30x	36 - 8.5	10x - 40x	25 - 5.8
	1.5x	15x - 60x	15 - 4.8	22.5x - 90x	10.5 - 2.5	30x - 120x	7 - 1.8
	2.0x	20x - 80x	11 - 5.3	30x - 120x	8 - 2	40x - 160x	5.5 - 1.5

▶ Zoom stereomicroscopes, series Z



- 1| Handle for easy transport
- 2| 45° inclined and 360° rotary head with interpupillary distance adjustment and dioptre correction
- 3| Possibility of placing the head at two different heights thus allowing observation of samples of a wide range of sizes.
- 4| Zoom range from 0.7x to 4.5x
- 5| Working distance 100 mm
- 6| Incident and transmitted LED lights with independent intensity regulation

Code	HDD011	HDD012
Model	B-HD11	T-HD12
Head	Binocular	Trinocular
	45 ° inclined and 360° rotatable	
Interpupillary distance	55-75 mm	
Zoom ration	1:6.4	
Eyepieces	WF10x/20 mm	
Objective	1x	
Zoom	0.7x-4.5x	
Working distance	100 mm	
Illumination	Incident and transmitted LED lights	
Power supply	110-240 V; 50/60 Hz	



▶ HDD - Zoom

▶ Serie 240



- 1 | Large stage and very robust design. Large dimensions stage Ø 120 mm.
- 2 | Working distance of 95 mm. Adjustable zoom from 0.65x to 6x.

Code	HDD007	HDD008
Model	240/2	240/3
Head	Binocular 45° 360°	Trinocular 45° 360°
Interpupillary distance	55-75 mm	
Diopter correction	± 5 diopters	
Eyepieces	WF 10x-23 mm (Ø23mm)	
Objectives	1x	
Zoom	0.65x a 6x (bilateral controls)	
Working distance	95 mm	
Stage	White and black ground glass (Ø 120 mm) with clamps	
Illumination	Incident (6V/15W) and transmitted (6V/12W)	
Power	220V, 50Hz	

Chart of magnification Mod. 240

Zoom	Objectives	Eyepiece WF10X		Eyepiece WF15X		Eyepiece WF20x	
		Magnification	field Ø (mm)	Magnification	field Ø (mm)	Magnification	field Ø (mm)
0.65x-6x	1.0x	6.5x - 60x	35.4 - 3.8	9.75x - 90x	23.1 - 2.5	13x - 120x	18.5x - 2.0
	0x	13x - 120x	7.69 - 1.91	19.5x - 180x	11.5 - 1.3	26x - 240x	9.2 - 1

▶ Video-microscopes



REF. HDD009



REF. HDD10



- 1 | Equipped with a 1/3" CCD camera and a 0.5x coupler.
- 2 | Lateral control panel with buttons to adjust brightness, turn on the laser pointer or make the white balance.
- 3 | Built-in LED ring whose intensity can be adjusted.
- 4 | With a laser pointer (5V 650 nm).
- 5 | Body presents a standard diameter of 7 mm, it can be configured with the objectives and stands or base that are more appropriate for user necessities (see accessories)
- 6 | For observation of samples in 3D (optional).

Code	HDD009	HDD010
Model	290/8	290/10
Head	Binocular	Trinocular
LCD monitor		
Screen size	8"	10,4"
Resolution	800 x 600/1024 x 768	
Contrast	300:1	350:1
Viewing angle	150°	150°
Response time	≤ 25ms	≤ 25ms
Brightness	250 cd/m ²	300 cd/m ²
Video output	Conector BNC/Conector S-VIDEO	
Optical specifications		
Total magnifications	3,3x-147x	3,2x-198x
Zoom range	0,7x - 4,5x	0,7x - 4,5x
Zoom ratio	1:6,5	1:6,5
Objectives	1x standar 0,3x, 0,5x, 0,75x, 1,5x y 2x (optional)	
Power	100-240V, 50/60 Hz	

Chart of magnifications model 290/8 (8" LCD monitor)

Objectives	Magnification	Field Ø	Working dist.
0.3x	3.6x - 22.9x	57.1-8.9 mm	331 mm
0.5x	5.9x - 38.1x	34.3-5.3 mm	198 mm
0.75x	8.9x - 57.1x	22.8-3.6 mm	131 mm
1.0x (standard)	11.9x - 76.2x	17.1-2.7 mm	96 mm
1.5x	17.8x - 114.3x	11.4-1.8 mm	63 mm
2.0x	23.7x - 152.4x	8.6-1.3 mm	46 mm

Chart of magnifications model 290/10 (10.4" LCD monitor)

Objectives	Magnification	Field Ø	Working dist.
0.3x	3.6x - 22.9x	57.1-8.9 mm	331 mm
0.5x	5.9x - 38.1x	34.3-5.3 mm	198 mm
0.75x	8.9x - 57.1x	22.8-3.6 mm	131 mm
1.0x (standard)	11.9x - 76.2x	17.1-2.7 mm	96 mm
1.5x	17.8x - 114.3x	11.4-1.8 mm	63 mm
2.0x	23.7x - 152.4x	8.6-1.3 mm	46 mm

▶ HDG - Accessories, objectives

Code	Description
HDG001	Objectives 1x for series 200
HDG002	Objectives 2x for series 200
HDG003	Objectives 3x for series 200
HDG004	Objectives 4x for series 200
HDG005	Objectives 0.5x for series 230
HDG006	Objectives 2x for series 230/240
HDG007	Objectives 0.5x for series 234 (pole stand)
HDG008	Objectives 1.5x for series 234 (pole stand)
HDG009	Objectives 2x for series 234 (pole stand)
HDG010	Objectives 0.3x for LCD microscopes
HDG011	Objectives 0.5x for LCD microscopes
HDG012	Objectives 0.75x for LCD microscopes
HDG013	Objectives 1.5x for LCD microscopes
HDG014	Objectives 2x for LCD microscopes
HDG015	35° 3D attachment with objective 0.75x

▶ HDH - Accessories, eyepieces

Code	Description
HDH001	Eyepiece 5x for series 200/234
HDH002	Eyepiece 10x for series 200/234
HDH003	Eyepiece 15x for series 200/234
HDH004	Eyepiece 20x for series 200/234
HDH005	Eyepiece micrometer 10x for series 200/234
HDH006	Eyepiece 10X for series 230/240
HDH007	Eyepiece 15x for series 230/240
HDH008	Eyepiece 20x for series 230/240
HDH009	Micrometric eyepiece 10x for serie 230 240
HDH010	Photographic eyepiece 2,5x for serie 230/240
HDH011	Photographic eyepiece 5x for serie 230/240

▶ HDJ - Accessories, support



REF. HDJ002



REF. HDJ006



REF. HDJ005

Code	Description
HDJ001	Articulated Base for stereo series 234
HDJ002	Post stand 76 mm, for LCD microscope
HDJ003	Track stand 76 mm for LCD microscope
HDJ004	Halogen light base for LCD microscope
HDJ005	Big Base Boom stand for microscope LCD
HDJ006	Pneumatic stand 76 mm f/LCD microscope



HDK - Accessories, others

▶ Cold light source



- 1 | For microscopic examinations, illumination of certain regions or observation of heat-sensitive samples.
- 2 | Equipped with a high power lamp, without colour change and without heat release.
- 3 | Double flexible arm and a mechanism for continuous adjustment of illumination intensity.
- 4 | Included two Köhler condenser and slot for inserting colour filter.

Code	HDK001
Spectral range	450-700 nm
Halogen lamp	21 V / 150 W
Dimensions	208x105x124 mm
Height	1 kg
Power	CA 220 V, 50-60 Hz

▶ Illumination

Code	Description
HDK002	24 V 150 W lamp cold light source
HDK003	Halogen lamp 12V 10W for series 200/234
HDK012	Halogen lamp 6V 12W for series 230/240
HDK013	Dicroic halogen lamp 6V 15W
HDK017	Dicroic halogen lamp 12V 10W

▶ Others

Code	Description
HDK004	Pair of clips for holding slides for series 200
HDK005	White/Black contrast stage plate series 200/234, 95 mm
HDK006	Pair of blinkers for stereomicroscope
HDK007	Ground glass stage plate for series 200/234, 95 mm
HDK008	Plastic dust cover
HDK009	Ground glass stage plate for serie 220, 60 mm
HDK014	Black/white contrast stage for 230
HDK015	Ground stage series 230
HDK019	Ground stage series 240 (diam. 120 mm)



HGD - C mount

▶ Eyepiece video cameras



Code	HGB002	HGB003	HGB004	HGB005
Sensor	1/2"CMOS	1/2"CMOS	1/2.2"CMOS	1/2.5"CMOS
Max. resolution	1280x1024	2048x1536	2592x1944	3264x2448
Speed máx. resolution	20 FPS	<11 FPS	<7 FPS	<1 FPS
Sensibility (v/lux-s a 550 nm)	1.8	1.5	1.2	1.3
Dynamic range	65 dB	75 dB	67 dB	75 dB
Wavelength	400-600 nm (with IR-cut filter)			
Eyepiece Ø	23 mm (adapters of 30 and 30.5 mm)			
Dimensions	Cylindrical-shaped metal body, 50 mm diameter			
White balance	Automatic / Manual			
Interface	USB 2.0, 480 Mb/s; length of wire 2.5 m			

HJB - Visible

► Serie 4100



- 1| Manual wavelength selector and digital display .
- 2| Blank (0% Abs) and auto zero (0% T) easy to perform.
- 3| Measurements of absorbance and transmittance in the visible spectral range.
- 4| Model 4111RS allows quantitative analysis by taking a sample of known concentration as reference or by entering the F factor value (Abs = F-Conc). Is provided with RS232 output to connect to a computer and application software based on Windows that allows calculation of concentration curves using up to 12 reference samples, and kinetics curves
- 5| Includes 2 glass cells, 10 mm path length and black cell for autocero.

Code	HJB001	HJB002
Model	4101	4111RS
Wavelength adjustment	Manual	
Wavelength range	330 – 1000nm	
Optical system	Single beam, grating 1200 lines / mm	
Bandwidth	8nm	
Wavelength accuracy	±2nm	
Wavelength resolution	±1nm	
Photometric accuracy	0-100%T 0-1,999A 0-1999C; 0-1999F	
Detector	Silicon photodiode	
Cell holder	2 cells of 10 mm path length	
Output	---	RS232
Power	110V 60Hz / 220V 50Hz trough an external exchanger	

REF. HJB001



REF. HJB002

page
[127]

► Serie 4201/20



- 1| Manually setting wavelength.
- 2| Auto-zero and blank, easy to use. Press one button for easy switching of Transmittance, Absorbance and Concentration modes.
- 3| Windows based Software included that can expand the applications to standard curve calculations through the USB port.

Code	HJB003
Model	4201/20
Wavelength adjustment	Manual
Wavelength range	325-1000nm
Optical system	Single beam, grating 1200 lines/mm
Bandwidth	4nm
Wavelength accuracy	±2nm
Wavelength resolution	±1nm
Photometric accuracy	-0,097 - 1,999A, 0 - 125%T
Detector	Silicon photodiode
Cell holder	4-position 10 mm cell changer
Output	USB and parallel port (printer)
Lamps	Tungsten
Power	110V 60Hz/220V 50Hz (external exchanger)



HJB - Visible

► Serie 4211/20



- 1| Memory to save up to 200 absorbance and transmittance data. The memory can also store up to 200 different standard curves .
- 2| Software MWave Basic included. Compatible with software MWave Professional (not included)
- 3| Reading: absorbance, transmittance and concentration (standard curve and coefficient methods)

Code	HJB004
Wavelength range	325-1000nm
Optical system	Single beam, grating 1200 lines/mm
Bandwidth	4nm
Wavelength accuracy	± 1nm
Wavelength resolution	± 1nm
Photometric accuracy	-0,097 - 2,5 A 0 - 125% T
Lamps	Tungsten
Detector	Silicon photodiode
Standard cell holder	4 cells standar de 10 mm
Output	USB and parallel port (printer)
Power	110 V 60 Hz / 220 V 50 HZ (external exchanger)

► Portable



- 1| Windows CE embedded operating system and touch screen TFT interface
- 2| Data can be transferred from internal instrument storage to a PC via USB connection and the 4430 Data Viewer Software.
- 3| The 4431 differentiates itself from the standard 4430 by means of pre-programmed test methods for the Spectroquant® series of reagent test kits from Merck Chemicals.
- 4| Operating system and workspace: quantitative, spectrum, photometric and kinetic.

Code	HJB005	HJB006
Model	4430	Pre-programmed 4431
Wavelength range	380 – 800nm	
Optical system	Polychromatic with concave holographic grating	
Bandwidth	4 ± 0,8nm	
Wavelength accuracy	± 1nm	
Wavelength resolution	0,4nm	
Wavelength repeatability	≤ 0,1nm	
Stray light	≤ 0.5%	

HJD - UV/Visible

► Model 4201/50



- 1| Auto-sero and black easy to use.
- 2| Reading: absorbance, transmittance and concentration (standard curve method).
- 3| Can display and save 50 groups of data, 3 groups per screen.
- 4| MWave Basic Software included.

Code	HJD001
Wavelength adjustment	Digital
Wavelength range	200-1000nm
Bandwidth	4nm
Optical system	Simple beam, grating 1200 lines/mm
Wavelength accuracy	± 2nm
Wavelength resolution	± 1nm
Photometric accuracy	-0,097 - 1,999A, 0 - 125%T
Detector	Silicon photodiode
Cell holder	4-position 10 mm cell changer
Output	USB and parallel port (printer)
Power	110 V 60 Hz / 220 V 50 HZ (external exchanger)
Lamps	Tungsten and deuterium

▶ HJD - UV/Visible

▶ Model 4211/50



- 1| Memory to save up to 200 absorbance and transmittance data. The memory can also store up to 200 different standard curve.
- 2| They allow qualitative (absorbance and transmittance measurements) and quantitative (concentration measurements) analysis in the visible and UV-visible range respectively.
- 3| MWave Basic Software included, compatible with software MWave Professional (not included).



Code	HJD002
Model	4211/50
Wavelength range	200-1000nm
Optical system	Simple beam, grating 1200 lines/mm
Bandwidth	4nm
Wavelength accuracy	± 1nm
Wavelength resolution	± 1nm
Wavelength reproducibility	0,5nm
Photometric accuracy	-0,097 - 2,5 A, 0 - 125% T
Lamps	Tungsten and deuterium
Detector	Silicon photodiode
Standard cell holder	4 cells standar de 10 mm
Output	USB and parallel port (printer)
Power	110 V 60 Hz / 220 V 50 Hz (external exchanger)

page
[129]

▶ Model 4251/50



- 1| Memory to save up to 200 groups of data. The memory can also store and reload up to 200 different standard curves.
- 2| Reading: absorbance, transmittance, concentration (standard curve and coefficient methods) and kinetics.
- 3| MWave Basic Software included, compatible with software MWave Professional (not included).



Code	HJD003
Model	4251/50
Wavelength range	190-1100nm
Optical system	Simple beam, grating 1200 lines/mm
Bandwidth	2nm
Wavelength accuracy	±0,5nm
Wavelength resolution	±0,1nm
Wavelength reproducibility	0,3nm
Photometric accuracy	-0,3 - 3 A, 0 - 200% T
Lamps	Tungsten and deuterium
Detector	Silicon photodiode
Standard cell holder	4 cells standar de 10 mm Path lengt
Output	USB and parallel port (printer)
Power	110 V 60 Hz / 220 V 50 Hz (external exchanger)

▶ HJD - UV/Visible

Zuzi

▶ Model 4255/50



- 1 | Memory to save data and curves.
- 2 | Advanced and complete functions to cover all range of applications: basic mode (Absorbance and transmittance), qualitative, wavelength scan, kinetics, DNA/proteins and multi-wavelength analysis.
- 3 | Compatible with software UV/Vis Analyst (not included)

Code	HJD004
Wavelength range	190-1100 nm
Optical system	Simple beam, grating 1200 lines/mm
Bandwidth	2nm
Wavelength accuracy	±0,5nm
Wavelength resolution	±0,1nm
Wavelength repeatability	0,3 nm
Scan speed	High, medium, low (max. 3000nm/min)
Photometric accuracy	-0,3 - 3 A, 0 - 200% T, 0 - 9999 C
Lamps	Tungsten and deuterium
Detector	Silicon photodiode
Standard cell holder	4 position 10 mm cell charger
Output	USB and parallel port (printer)
Power	110 V 60 Hz / 220 V 50 Hz (external exchanger)

▶ Model 4481/1



- 1 | Large color touch screen 7 " LCD (153x85 mm).
- 2 | The spectrophotometer provides a large memory capacity; 10 concentration curves, 10 spectrum scanning curves and 10 kinetic curves.
- 3 | Motorised automatic 8-cells holder for 10 mm path-length cells.
- 4 | Testing and processing data provided by the equipment: photometric measurement, quantitative analysis, chemical kinetic analysis, multi-wavelength determination, spectrum scanning, zoom in/out of spectrum graph, saving and recalling of curve, calibration and search and printing of peak value
- 5 | Compatible with software UVWin 8 (not included).

Code	HJD006
Beam	Simple
Wavelength range	190 – 1000 nm
Bandwidth	2nm
Wavelength accuracy	±0,5nm
Wavelength repeatability	0,2 nm
Photometric accuracy	-0,3 – 4Abs
Scan speed	High, medium, low
Detector	Silicon photodiode
Power	220V 50 Hz

▶ UV-VIS 4419



- 1 | Czerny-Turner monochromator with holographic grating that reduces stray light to a minimum and offers excellent optical resolution. .
- 2 | Double beam optical system coupled with a high specification holographic grating gives excellent wavelength separation allowing the user to measure close adjacent wavelengths with excellent sensitivity.
- 3 | Continuous selection of bandwidth .
- 4 | Operational and data processing capabilities: photometric measurements, multiple wavelength analysis, quantitative analysis, kinetics, scanning and DNA/protein analysis.
- 5 | Included software UVWin (continuous mode not available).

Code	HJD005
Optical system	Double beam
Wavelength	190 – 900nm
Bandwidth	Continuous slit 0.1-5nm (with 0.1 nm interval)
Wavelength accuracy	±0,3nm
Wavelength reproducibility	0,1nm
Photometric accuracy	-0,4 – 4Abs
Detector	Photomultiplier tube
Power	120-230 V CA, 50-60 Hz

▶ HJD - UV/Visible



▶ Double beam model 460/50

- 1| Double beam optical system with two detectors that measure sample and reference respectively and simultaneously for optimizing precision of measurement.
- 2| This equipment presents different operation modes for performing quantitative analysis, kinetics, scanning, multiple wavelength analysis and DNA/protein analysis thus being a suitable equipment for applications in Pharmaceuticals, Biochemistry, Quality control, research and clinical laboratories.
- 3| Measurement range 190-1100 nm with a variable bandwidth (0.5/1/2/4/5 nm)
- 4| The spectrophotometer is supplied with UV/Vis Analyst application software based in Windows for total control of equipment through computer



Code	HJD007
Wavelength range	190-1100 nm
Wavelength accuracy	± 0.3 nm
Wavelength repeatability	0.2 nm
Spectral bandwidth	Variable: 0.5/1/2/4/5 nm
Photometric accuracy	0-200% T, -0.3 – 3 A
Photometric accuracy	± 0.3% T o ± 0.003 A @ 1 A
Optical system	Double beam, grating 1200 lines/mm
Scan speed	High, medium, low (max. 3000 nm/min)
Stray light	0.04% T @ 220 nm, 360 nm
Stability	0.0003 A/h @ 500 nm
Baseline flatness	± 0.0005 A
Display	5 inches LCD (320x240 dots)
Standard cell holder	10 mm single cell holder (sample and reference)
Cells	4 glass cells and 2 quartz cells included
Light source	Tungsten and Deuterium lamps (pre-aligned)
Outputs	USB type A for USB memory device (right side) USB type B for PC connection (back side) Parallel port for printer
Power	AC 110/220 V, 50/60 Hz
Dimensions (LxWxA)	589x428x200 mm
Weight	22 Kg

page
[131]

▶ HJG - Checking standards

- 1| These standards are used to verify absorbance measurements in visible range and wavelength in visible UV ranges.
- 2| Each filter is mounted in a case, which is compatible with the 1 cm cell holder generally supplied with the spectrophotometers.
- 3| With absorbance and wavelength data certificate.

▶ Didimium glass filter



- 1| Solid filter to test the accuracy on the wavelength in the visible range and UV (from 329 nm to 875 nm) and check the photometric accuracy.

Code	HJG001
Description	Didimio (F5)
Peak position (nm)	327, 473, 513, 684, 875
Nominal absorbance	5.0 (280 nm) 3.0 (300 nm) 0.5 (320 nm) 0.2 (340 nm)



HJG - Checking standards

▶ Neutral density glass filters



- 1 | Grey glass filter to verification of photo metry accuracy (absorbance) in the visible range (440 nm a 635 nm).
- 2 | Show a quite constant transmission along the visible spectro being calibrated in different wavelengh.
- 3 | The thickness of the glass filter has been adjusted to give nominal absorbance values from 0.25 A, 0.5 A y 1 A.

Code	Des.	Nominal absorbance	Absorbance measured at (nm)
HJG003	F2	0.25 A	440, 465, 546, 590, 635
HJG004	F3	0.5 A	440, 465, 546, 590, 635
HJG005	F4	1.0 A	440, 465, 546, 590, 635

▶ Filter set



- 1 | It includes a holmium oxide glass filter (HO₂O₃) for wavelength accuracy verification and 3 glass filter with neutral density for photometric accuracy verification.
- 2 | All together, with an empty filter mount in a wood case.
- 3 | The absorbance and wavelength values for the peaks are registered in the calibration certificate that goes with each filter set. A copy of these values, for ordinary use, is in the internal part of the case lid.

Code	HJG007		
Composed of	Filter	Description	Absorbance measured at (nm)
	F1	Holmium oxide	279, 364, 454, 536, 638
	F2	Grey glass density	440, 465, 546, 590, 635
	F3	Grey glass density	440, 465, 546, 590, 635
	F4	Grey glass density	440, 465, 546, 590, 635

▶ Filters accessories

Code	Description
HJG002	Empty filter mount
HJG006	Empty case for 5 filters

HJH - Accessories

▶ CHART 4: 'accessories spectrophotometers 4100, 4419, 4201/20, 4200, 4481/1, 4211/20, 4211/50, 4251/50, 4255/50, 4481/1'

Code	Description
HJH001	Cell holder, series 4100
HJH002	Dust cover spectrophotometer 4100
HJH003	Halogen lamp 6 V 10 W, Series 4100 and 4201/20
HJH004	Blanck cell, 10 mm
HJH005	Dust cover spectrophotometer 4200
HJH006	Halogen lamp 12 V 20 W, series 4200
HJH007	Deuterium lamp, series 4200
HJH010	Hamamatsu deuterium lamp L6302-40
HJH017	Sipper pump system, model 4419
HJH018	Thermostatizable cell holder 2 cells, 4419
HJH019	Cell holder f/cells 5-50 mm, model 4419
HJH021	Deuterium lamp for spectrophotometer model 4481/1
HJH022	Adapter for cells 1 to 5 mm
HJH024	Tugsten lamp for spectrophotometer model 4481

HJH - Accessories

Code	Description
HJH008	Software MWave Professional, for models 4211/20, 4211/50, 4251/50
HJH009	Software UV/Vis Analyst, for model 4255/50
HJH020	Software spectrophotometer for model 4481/1

HJK - Cells, glass

Cells are supplied in paired up units and their main features are the following:

1| Material specifications: two types, optical glass for the visible spectrum (340-2500 nm) and synthetic quartz for ultraviolet spectrum (190-2500 nm).

3| Cells construction: made up by sinering its walls, that is, thanks to a heating process the melting point, of glass or quartz powder so that its articles adhere to each other pressure.

3| General features:

- Resistant to alcali, 6 mol/L of NOH kept in cells for 24 hours, with neither breakage nor leakage.

-Resistant to acids, 6 mol/L of HCl kept in cells for 24 hours, with neither breakage nor leakage.

- Resistant to organic solvents as ethanol (C₅H₅OH), carbon tetrachloride (CCl₄) or benzene (C₆H₆) kept in cells for 24 hours with neither breakage nor leakage.

Macro standard (10 mm)



- 1| The most common in analytic Chemistry.
- 2| They have two polished walls and are open at the top, though they are supplied with a plastic stopper (non hermetic).
- 3| External dimensions 12.5 x B x 45mm.

Code	Path length	Volume	Lot
HJK001	1 mm	0.35 mL	2
HJK002	2 mm	0.70 mL	2
HJK003	5 mm	1.70 mL	2
HJK004	10 mm	3.50 mL	2
HJK005	20 mm	7.00 mL	2
HJK006	40 mm	14.00 mL	2
HJK007	50 mm	17.50 mL	2



Macro standard with hermetic stopper (10 mm)



- 1| Included PTFE stopper, which seals the cells hermetically thus making them better for volatile fluids.
- 2| External dimensions: 12.5 x 12.5 x 48 mm.

Code	Path length	Volume	Lot
HJK008	10 mm	3.50 mL	2



Semi-micro with black walls and non hermetic stopper (4 mm)



- 1| For reducing the volume of sample necessary to make a reading.
- 2| Their black walls improve sensitivity by eliminating stray light of reading.
- 3| External dimensions 12.5 x B x 45 mm
- 4| With stopper (non hermetic).

Code	Path length	Volume	Lot
HJK009	5 mm	0.50 mL	2
HJK010	10 mm	1.00 mL	2
HJK011	20 mm	2.00 mL	2



▶ HJK - Cells, glass



▶ Semi-micro with black walls and hermetic stopper (4 mm)



- 1 | Included PTFE stopper, which seals the cells hermetically thus making them better for volatile fluids.
- 2 | External dimensions 12.5 x 12.5 x 48 mm.

Code	Path length	Volume	Lot
HJK012	10 mm	1.00 mL	2

▶ Micro with black walls (2 mm)



- 1 | For small sample volume.
- 2 | External dimensions 12.5 x 12.5 x 48 mm .
- 3 | With stopper (non hermetic).

Code	Path length	Volume	Lot
HJK013	10 mm	0.50 mL	2

▶ Micro with black walls and stopper (2 mm)



- 1 | Included PTFE stopper, which seals the cells hermetically thus making them better for volatile fluids.
- 2 | External dimensions 12.5 x B x 48mm

Code	Path length	Volume	Lot
HJK014	5 mm	0.25 mL	2
HJK015	10 mm	0.50 mL	2

▶ Flow-through cells

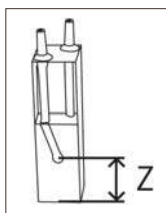

- 1 | Made of optical glass (G).
- 2 | Are used in those spectrophotometrical applications that require a measuring range from 340 nm to 2.5 μm.
- 3 | The cells present inlet and outlet tubes and two polished windows .
- 4 | Each model is supplied in a case with two units.
- 5 | External dimensions 12.5 x 12.5 x 45mm

Glass	Height Z	Path length	Volume	Lot
HJK016	8.5 mm	10 mm	0.07 mL	2
HJK017	15 mm	10 mm	0.07 mL	4

▶ HJL - Cells, quartz

Cells are supplied in paired up units and their main features are the following:

1 | Material specifications: two types, optical glass for the visible spectrum (340-2500 nm) and synthetic quartz for ultraviolet spectrum (190-2500 nm).

2 | Cells construction: made up by sinering its walls, that is, thanks to a heating process the melting point, of glass or quartz powder so that its articles adhere to each other pressure.

3 | General features:

- Resistant to alcali, 6 mol/L of NaOH kept in cells for 24 hours, with neither breakage nor leakage.

- Resistant to acids, 6 mol/L of HCL kept in cells for 24 hours, with neither breakage nor leakage.

- Resistant to organic solvents as ethanol (C₂H₅OH), carbon tetrachloride (CCl₄) or benzene (C₆H₆) kept in cells for 24 hours with neither breakage nor leakage.

▶ Standard macro (10 mm)



1 | The most common in analytic Chemistry.

2 | They have two polished walls and are open at the top, though they are supplied with a plastic stopper (non hermetic).

3 | External dimensions 12.5 x B x 45mm.

Code	Path length	Volume	Lot
HJL001	1 mm	0.35 mL	2
HJL002	2 mm	0.70 mL	2
HJL003	5 mm	1.70 mL	2
HJL004	10 mm	3.50 mL	2
HJL005	20 mm	7.00 mL	2
HJL006	40 mm	14.00 mL	2
HJL007	50 mm	17.50 mL	2



▶ Macro standard with hermetic stopper (10 mm)



1 | Included PTFE stopper, which seals the cells hermetically thus making them better for volatile fluids.

2 | External dimensions: 12.5 x 12.5 x 48 mm.

Code	Path length	Volume	Lot
HJL008	10 mm	3.50 mL	2



▶ Semi-micro with black walls (4 mm)



1 | For reducing the volume of sample necessary to make a reading.

2 | Their black walls improve sensitivity by eliminating stray light of reading.

3 | Dimensiones exteriores 12.5 x B x 45 mm

4 | With stopper (non hermetic).

Code	Path length	Volume	Lot
HJL009	5 mm	0.50 mL	2
HJL010	10 mm	1.00 mL	2
HJL011	20 mm	2.00 mL	2



HJL - Cells, quartz

▶ Semi-micro quartz cell with stopper (4 mm)



1 | Included PTFE stopper, which seals the cells hermetically thus making them better for volatile fluids.

2 | External dimensions: 12.5x12.5x48 mm

Code	Path lengt	Volume	Lote
HJL012	10 mm	1.00 mL	2

▶ Micro with black walls (2 mm)



1 | For small sample volume.

2 | External dimensions 12.5 x 12.5 x 48mm .

3 | With stopper (non hermetic).

Code	Path lengt	Volume	Lote
HJL013	10 mm	0.50 mL	2

▶ Micro with black walls and stopper (2 mm)



1 | Included PTFE stopper , which seals the cells hermetically thus making them better for volatile fluids.

2 | External dimensions 12.5 x B x 48mm

Code	Path lengt	Volume	Lote
HJL014	5 mm	0.25 mL	2
HJL015	10 mm	0.50 mL	2

HJM - Cells, others

▶ Glass tube for spectrophotometer (vis)



Zuzi

Code	Dimensions	Path length	Models
HJM001	12x100 mm	10 mm	4101 y 4111RS

▶ HMB - Polarimeters

▶ Models 404 and 404-LED



- 1| Inclined sample compartment for glass tube up to 220 nm.
- 2| Double reading scale with Vernier to avoid differences due to eccentricity.
- 3| Eyepiece provided with dioptic adjusting ring.
- 4| Two lateral 4x magnifying glasses facilitate scale readings.
- 5| Supplied with two samples tubes of 100 and 200 mm long respectively.



REF. HMB001

Code	HMB001	HMB002
Model	404	404-LED
Illumination	Sodium vapour lamp	LED + filter
Wavelegh	589,4 nm	589,4 nm
Nº scales	2	
Measuring range	2 scales (0-180°)	
Scale division	1°	
Vernier reading	0,05°	



REF. HMB002

▶ Model 412



- 1| Photoelectric detection, with RS 232 output.
- 2| Repetition of measurement 3 times and calculation of average value.
- 3| High sensitivity suitable for samples of low optical rotation which are difficult to analyzed by the optical polarimeter.
- 4| Supplied with two samples tubes of 100 and 200 mm long respectively.

Code	HMB003
Model	412
Range	From +45° a -45°
Accuracy	$\pm(0,001 + \text{medium valor} \times 0,05\%)$
Min. transmittance of sample	10%
Illumination	LED + filter (589,4nm)
Speed	1,3°/s



▶ Model 418



- 1| Advanced digital circuit and microprocess or control RS 232 output.
- 2| Repetition of measurement 3 times and calculation of average value.
- 3| Measure those dark coloured sample with transmittance near than 1%
- 4| Supplied with two samples tubes of 100 and 200 mm long respectively.

Code	HMB004
Model	418
Range	from +45° a -45°
Accuracy	$\pm 0,001^\circ$
Min. transmittance of sample	1%
Illumination	Sodium lamp + filter (589,4nm)
Speed	1°/s





HMB - Polarimeters



▶ Model 430



- 1 | Photoelectric detection and microprocessor control with RS232 output.
- 2 | Measurement of specific rotation, optical rotation and sugar degree.
- 3 | Repetition of measurement 3 times and calculation of average value and root mean square.
- 4 | Supplied with two samples tubes of 100 and 200 mm long respectively.

Code	HMB005
Model	430
Range	De +45° a -45° / De +130°Z a -130°Z
Accuracy	±0,01° + (medium valve×0,05%)/n10000 ±0,03°Z + (medium valve×0,05%)/n10000
Min. transmittance of sample	10%
Illumination	Sodium lamp + filter (589,4nm)
Speed	1°/s



HMF - Calibration pieces



- 1 | For checking the accuracy of measurements obtained with polarimeter.
- 2 | Quartz piece with metal mount.
- 3 | Supplied in case.

Code	Description
HMF001	Quartz piece for calibration of polarimeter +5°
HMF002	Quartz piece for calibration of polarimeter -5°
HMF003	Quartz piece for calibration of polarimeter +17°
HMF004	Quartz piece for calibration of polarimeter -17°
HMF005	Quartz piece for calibration of polarimeter +35°
HMF006	Quartz piece for calibration of polarimeter -35°



HMG - Accessories

REF. HMG005



REF. HMG006



Code	Description
HMG001	Sodium vapor lamp 589.3 nm
HMG002	Rubber joint for test tubes
HMG003	Test tube stopper
HMG004	Test tube circular glass disk 15 mm.
HMG005	Test tube for polarimeter 100 mm.
HMG006	Test tube for polarimeter 200 mm.

▶ HPB - Abbe

▶ Abbe model 315RS, digital



- 1 | Application on chemical, petroleum, food and pharmaceutical industries, universities and research..
- 2 | For measuring the refractive index (nD) of transparent or translucent liquids and solids as well as sugar concentration (° Bx).
- 3 | Automatic temperature compensation on the Brix scale.

Code	HPB001
Range	
Refractive index	1,3000-1,7000 nD
Brix	0-95%
Accuracy	
Refractive index	±0,0002 nD
Brix	± 0,1
Size	330 x180x380 mm
Temperature correction	15/45 °C
Weight	10 kg
Power	CA 220 V, 50-60 Hz



▶ Abbe model 325



- 1 | To measure refractive index and sugar concentration (Brix).
- 2 | With metal body, it is prepared to joint up a circulation thermostat; with digital thermometer.
- 3 | The scale is illuminated by means of natural light and the illumination can be incident transmitted.
- 4 | Magnifications of the optical system: 2x.

Code	HPB002
Range	
Refractive index	1,3000-1,7000 nD
Brix	0-95%
Accuracy	
Refractive index	±0,0005 nD
Brix	0,25%
Size	100x200x240 mm
Weight	2.6 kg



▶ HPD - hand, Brix scale



metal body



plastic body

1 | Each refractometer is supplied in a grey plastic box with a plastic pipette, a screwdriver, rubber eyecup and rubber handle.

2 | With metallic body except ECO model (plastic body).

▶ HPD - hand, Brix scale

▶ 0-10% Brix

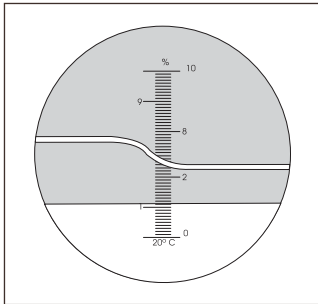

- 1 | Suitable for samples with low concentration of dissolved solids (lower than 10%) as for example tomatoes, low concentrated juices and industrial oils.
- 2 | Calibration is performed with distilled water adjusting to zero.

Code	Range	Accuracy	ATC (10-30°C)
HPD001	0-10% Bx	0.1%	No
HPD012	0-10% Bx	0.1%	Yes

▶ 0-20% Brix

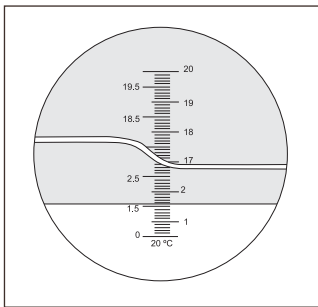

- 1 | Suitable for low concentrations (juices of fruits, alcohol-free beverages) except grape juice.
- 2 | Calibration is performed with distilled water.

Code	Range	Accuracy	ATC (10-30°C)
HPD002	0-20% Bx	0.1%	No
HPD013	0-20% Bx	0.1%	Yes

▶ 0-32% Brix

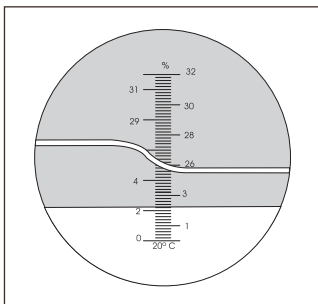

- 1 | Suitable for low concentrations usually used for fruits, juices, beverages, dairy products, milk products, industrial oils...
- 2 | Calibration is performed with distilled water.

Code	Range	Accuracy	ATC (10-30°C)
HPD003	0-32% Bx	0.2%	No
HPD014	0-32% Bx	0.2%	Yes

▶ 28-62% Brix

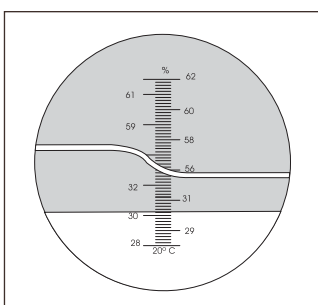

- 1 | Suitable for mild-range concentrations as for example are concentrated juices, jams, canned foods...
- 2 | Calibration is performed with a 28% sugar solution in distilled water, that means 28 g of sugar in a 100 ml of solution.

Code	Range	Accuracy	ATC (10-30°C)
HPD004	28-62% Bx	0.2%	No
HPD015	28-62% Bx	0.2%	Yes

▶ HPD - hand, Brix scale

▶ 40-82% Brix



- 1 | Model suitable for high concentration as for example condensed milk, liquid caramel, high concentrated juices, jams, etc.
- 2 | Calibration is performed with a 45% sugar solution in distilled water, that means 45 g of sugar in a 100 ml of solution.

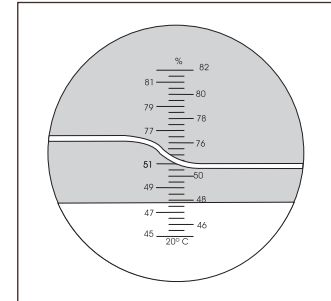

Code	Range	Accuracy	ATC (10-30°C)
HPD005	40-82% Bx	0.5%	No
HPD016	40-82% Bx	0.5%	Yes

▶ 58-92% Brix



- 1 | Model for high concentrations of sugar in honey .
- 2 | Calibration is performed with 58% sugar solution in distilled water, that means 58 g of sugar in a 100 ml of solution.

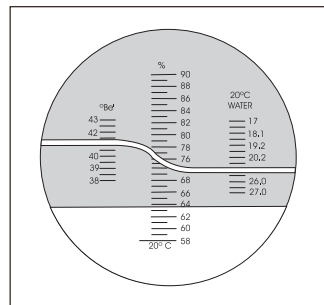

Code	Range	Accuracy	ATC (10-30°C)
HPD006	58-92% Bx	0.5%	No
HPD017	58-92% Bx	0.5%	Yes

▶ 58-92% Brix | 38-43 ° Baume | 12-27% Water



- 1 | This refractometer is specially suited for analyzing the three main values in honey; sugar content, Baumé degrees and water content..
- 2 | Calibration is performed with a test piece and bromonaphtalene, both included.

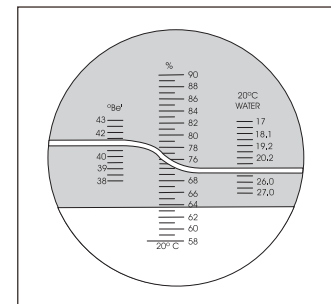

Code	HPD007	HPD018
Range	58-92% Bx 38-43 °Bé 12-27% Watter	
Accuracy	0.5% 0.5° 0.5%	
ATC (10-30°C)	No	Yes

▶ 0-50% Brix



- 1 | Model used for concentrated solutions of grape juice.
- 2 | Calibration is performed with distilled water.

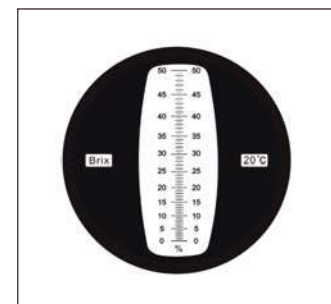

Code	Range	Accuracy	ATC (10-30°C)
HPD008	0-50% Bx	0.5%	No
HPD019	0-50% Bx	0.5%	Yes

▶ HPD - hand, Brix scale

▶ 0-80% Brix | 0-80% Brix (2 scales)

ZuZi

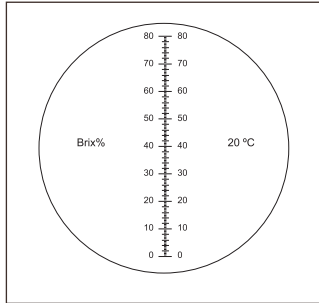

- 1 | This refractometer has a wide range 0-80% Brix, suitable for analyzing very different types of samples.
- 2 | The line in this model is in blue or white.
- 3 | It is used for fruit juices, alcohol-free beverages or even industrial oils.
- 4 | Calibration of models HPD009 and HPD020 is performed with distilled water.

Code	Range	Accuracy	ATC (10-30°C)
HPD009	0-80% Bx	0.5%	No
HPD020	0-80% Bx	0.5%	Yes
HPD021	0-80% Bx (0-50% 50-80%)	1%	No

▶ 0-90% Brix | 0-90% Brix (3 scales)

ZuZi



- 1 | Has a wide range 0-80% Brix, it allows the measurement of very different types of samples.
- 2 | Calibration is performed with distilled water (model HPD011)

Code	Range	Accuracy	ATC (10-30°C)
HPD011	0-90% Bx	0.5%	No
HPD010	0-90% Bx (0-42% 42-71% 71-90%)	0.2%	No

▶ HPF - hand, salinity

▶ 0-100‰ Salt

ZuZi

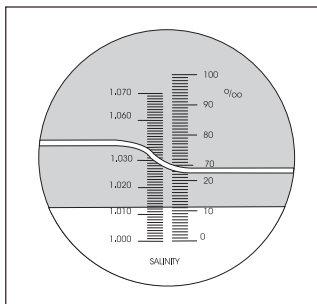

- 1 | Suitable for mild-range salt concentrations in sea water, food products... they have a specific gravity scale.
- 2 | Calibration is performed with distilled water.

Code	Range	Accuracy	ATC (10-30°C)
HPF001	0-100‰ Sal 1000-1070 mg/L	1‰ 0.001	No
HPF004	0-100‰ Sal 1000-1070 mg/L	1‰ 0.001	Yes
HPF007	0-100‰ Sal 0-10% Bx 1000-1070 mg/L	1‰ 0.1% 0.001	Yes

▶ 0-28% Salt

ZuZi

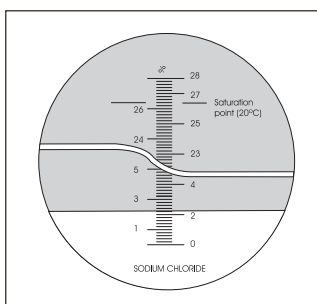

- 1 | Suitable to measure salt concentration of sea water, fish farms, aquariums, brines...
- 2 | Calibration is performed with distilled water.

Code	Range	Accuracy	ATC (10-30°C)
HPF002	0-28% Sal	0.2%	No
HPF005	0-28% Sal	0.2%	Yes

▶ HPH - Hand, oenology

▶ 2 scales (% alcohol y Baumé)



- 1| Suitable for measuring the alcohol content and Baumé grade in grape juice. It has no temperature compensation.
- 2| Calibration is performed with distilled water.

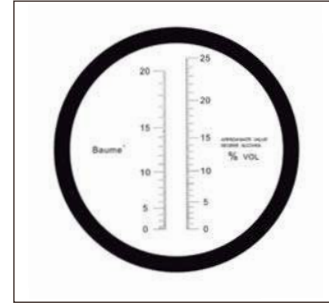

Code	Range	Accuracy	ATC (10-30°C)
HPH001	0-25% probable alcohol 0-22° Bé	0.2% 0.2°	No

▶ 0-25% probable alcohol



- 1| Designed to perform the measurement of alcohol in grapes.
- 2| It has temperature compensation between 10-30°C.
- 3| Calibration is performed with distilled water.

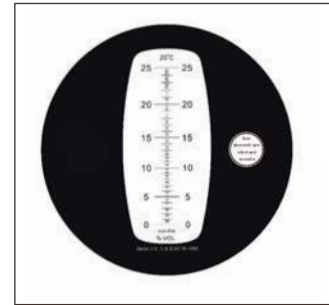

Code	Range	Accuracy	ATC (10-30°C)
HPH002	0-25% probable alcohol	0.2%	Yes

▶ 3 scales



- 1| Suitable to measure alcohol content in grape juice, Baumé degrees and Brix degrees, thus allowing to check the ripening level of grapes before and during the harvest.
- 2| Calibration is performed with distilled water.

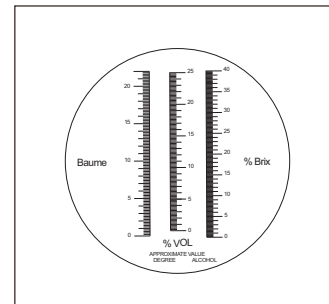

Code	Range	Accuracy	ATC (10-30°C)
HPH003	0-25% probable alcohol 0-22° Bé 0-40% Bx	0.2% 0.2° 1%	Yes
HPH004	0-25% probable alcohol 0-22° Bé 0-40% Bx (ECO)	0.2% 0.2° 1%	Yes

▶ 3 scales



- 1| Suitable for fruit juice concentration, with three different scales
- 2| Calibration is performed with distilled water.

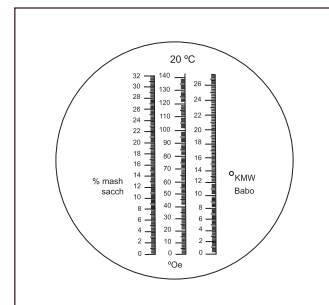

Code	Range	Accuracy	ATC (10-30°C)
HPH005	0-140° Oe 0-25° KMW Babo 0-32% mash sacch	1° 0.2° 0.2%	Yes

▶ HPH - hand, oenology

▶ 0-170° Oe

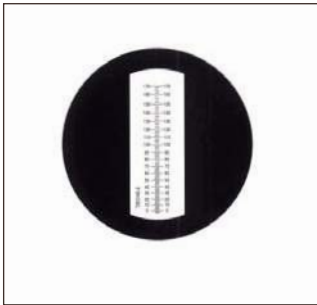

Zuzi

- 1 | Suitable to measure the concentration of fruit juice in Oe degrees.
- 2 | Calibration is performed with distilled water.
- 3 | Temperature compensation between 10-30 degrees.

Code	Range	Accuracy	ATC (10-30°C)
HPH007	0-170° Oe	2° Oe	Yes

▶ HPK - hand, batteries

▶ Batteries refractometers

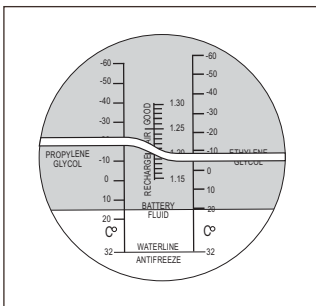

Zuzi

- 1 | Suitable for measuring the freezing point of antifreezes based on propylene glycol and ethylene glycol, as well as the state of electrolytic solutions of batteries and cleaning liquids.
- 2 | Calibration is performed with distilled water.

Code	Range	Accuracy	ATC (10-30°C)
HPK001	-60/32 °F (EG) -50/32 °F (PG) 1.15-1.30 sg	10 °F 0.01 sg	No

▶ Batteries refractometers

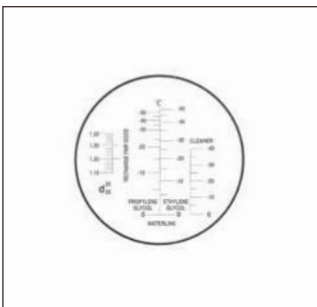

Zuzi

- 1 | Suitable to measure the freezing point of antifreezes based on propylene glycol and ethylene glycol, as well as the state of electrolytic solutions of batteries and cleaning liquids.
- 2 | It is also especially suited for measuring the urea content in petrol thanks by using reducing agents (AdBlue, EcoBlue).
- 3 | Calibration is performed with distilled water.

Code	Range	Accuracy	ATC (10-30°C)
HPK002	-50 a 0 °C (EG/PG) 1.15-1.30 sg -40 a 0 °C	5 °C 0.01 sg 5°C	No

▶ Batteries refractometer

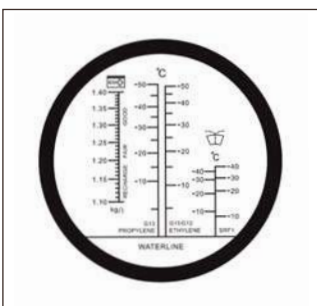

Zuzi

- 1 | Suitable to measure the freezing point of antifreezes based on propylene glycol and ethylene glycol, as well as the state of electrolytic solutions of batteries and cleaning liquids.
- 2 | Calibration is performed with distilled water.

Code	Range	Accuracy	ATC (10-30°C)
HPK005	-50 a 0 °C (EG/PG) 1.10-1.40 Kg/L -40 a 0 °C	5°C 0.01 Kg/L 10°C	Yes

▶ HPH - hand, batteries

▶ Batteries refractometer

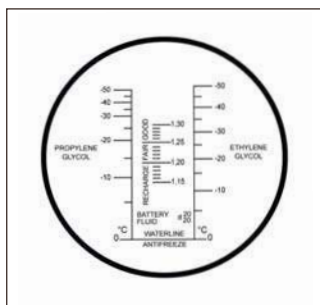

- 1| Suitable to measure the freezing point of antifreezes based on propylene glycol and ethylene glycol, as well as the state of electrolytic solutions of batteries.
- 2| Calibration is performed with distilled water.

Code	Range	Accuracy	ATC (10-30°C)
HPK006	-50 a 0 °C (EG/PG) 1.15-1.30 sg	5 °C 0.01 sg	Yes

▶ HPM - Hand, clinical

▶ Hand, clinical 3 scales

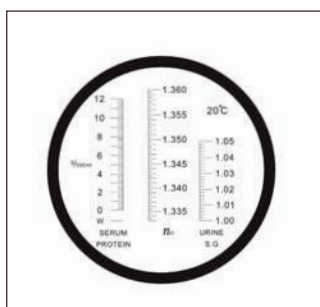

- 1| It has three scales; proteins in serum, urine specific gravity and refractive index.
- 2| Calibration is performed with distilled water (the separating line must match the value 1.333 of the refractive index scale).

Code	Range	Accuracy	ATC (10-30°C)
HPM001	0 - 12 g/dl	0.2 % g/dL	No
	1.000-1.050 sg	0.002 sg	
	1.333-1.360 nD	0.005 nD	
HPM002	0 - 12 g/dl	0.2 % g/dL	Yes
	1.000-1.050 sg	0.002 sg	
	1.333-1.360 nD	0.005 nD	

▶ Hand, clinical URIVET



- 1| Designed for veterinary use, especially for the analysis of cats and dogs serum. Simple, easy and fast, only with a drop it gives you a result.

Code	Range	Accuracy	ATC (10-30°C)
HPM003	2-14 g/100 mL 1.000-1.060 sg	0.1 g/100 mL 0.001 sg	YES

▶ HPP - Hand, others

▶ Hand refractometer

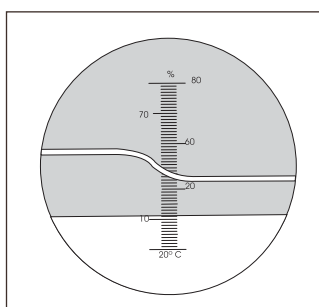

- 1| Suitable to measure the alcohol degree in a solution, it can be used for wines and spirits taking into consideration other parameters.
- 2| Calibration is performed with distilled water.

Code	Range	Accuracy	ATC (10-30°C)
HPP001	0-80% Alcohol (w/w)	1%	No

▶ HPP - Hand, others

▶ Refractometer for milk

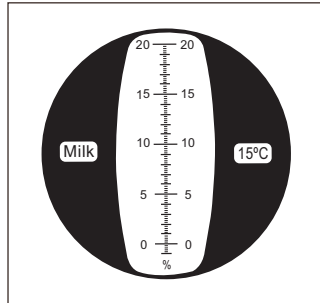

- 1 | Suitable for measuring the water content in milk.
- 2 | Calibration is performed with distilled water.

Code	Range	Accuracy	ATC (10-30°C)
HPP002	-1%-20%	0.2%	Yes

▶ Refractometer 1.333-1.520 nD, 3 scales



- 1 | For measuring the dissolved solid concentration (%Brix) or refractive index (nD) of aqueous solutions.
- 2 | Allow the analysis of a large variety of samples since they are provided with 3 scales that cover a wide range of measurement.

Code	Range	Accuracy	ATC (10-30°C)
HPP003	1.333-1.515 nD (3 escalas) (1.333-1.400 nD 1.400-1.470 nD 1.470-1520 nD)	0.0005 nD	No

▶ Hand refractometers, accessories



Code	Description
HPP004	Cover prism plate, two pieces
HPP005	Blinker for hand refractometers
HPP006	Plastic Box for hand refractometers
HPP007	Test Piece for the calibration of Abbe Refractomet
HPP008	Lamp 6.3v, 2.5w for ABBE Refractometer 315
HPP009	Digital thermometer f/refractometer 325

 RESUME CHART OF REFRACTOMETERS

Type	No ATC	ATC (10-30°C)	Range	Accuracy	Calibration
BRIX	HPD001	HPD012	0 - 10%	0.1 %	Distilled water
	HPD002	HPD013	0 - 20%	0.1 %	Distilled water
	HPD003	HPD014	0 - 32%	0.2 %	Distilled water
	HPD004	HPD015	28 - 62%	0.2 %	Solution 28%sugar/water
	HPD005	HPD016	40 - 82%	0.5 %	Solution 45%sugar/water
	HPD006	HPD017	58-92%	0.5 %	Solution 58%sugar/water
	HPD007	HPD018	58 - 92% Bx 38 - 43 ° Bé 12 - 27% Water	0.5 % Bx 0.5 ° Bé 0.5 % Water	Bromonaphtalene + test piece
	HPD008	HPD019	0 - 50%	0.5 %	Distilled water
	HPD009	HPD020	0 - 80%	0.5 %	Distilled water
	HPD021		0-50% Bx 50-80% Bx	1 %	Distilled water
	SALINITY	HPD011		0 - 90%	0.5 %
HPF001		HPF004	0 - 100‰ Salt 1000-1070 g/mL	1‰ 0.001 g/mL	Distilled water
HPF002		HPF005 HPF007	0 - 28% Salt 0 - 100‰ Salt 0 - 10% Bx 1000-1070 g/mL	0.2 % 1 ‰ 0.1 % 0.001 g/mL	Distilled water Distilled water
CLINICAL	HPM001	HPM002	0 - 12 g/dl de Proteins in serum 1.000 - 1.050 Specific weight (sg) 1.333 - 1.360 nD (refraction index)	0.2 % g/dL 0.002 sg 0.005 nD	Distilled water
	VETERINARY	HPM003	2 - 14 g/100 mL de Proteins in serum 1.000 - 1.060 Specific weight	0.1 0.001	
MOSTOS Y ALCOHOLES	HPPO01		0 - 80% Alcohol (w/w)	1 %	Distilled water
		HPH003 HPH004 (ECO)	0 - 25% probable alcohol 0-22° Bé 0-40% Bx	0.2 % probable alcohol 0.2° Bé 1 % Bx	Distilled water
		HPH001 (ECO)	0 - 25% probable alcohol 0-22° Bé	0.2 % probable alcohol 0.2° Bé	Distilled water
		HPH002 HPH005	0 - 25% probable alcohol 0-140° Oe	0.2 % probable alcohol 1° Oe	Distilled water Distilled water
FRUIT JUICE			0-25° KMW Babo 0-32% mash sacch	0.2° KMW Babo 0.2% mash sacch	
		HPH007	0-170° Oe	2° Oe	Distilled water
MILK		HPP002	-1%-20%	0.2%	Distilled water
BATTERIES AND ANTI-FREEZES	HPK001		- 60 a 32°F (EG) -50 a 32 °F (PG) 1.15 - 1.30 sg (Batteries)	10 °F 0.01 sg	Distilled water
	HPK002		-50 a 0 °C (EG/PG) 1.15 - 1.30 sg (Batteries)	5 °C 0.01 sg	Distilled water
			-40 a 0 °C (Cleaning)	5°C	
		HPK005	-50 a 0 °C (EG/PG) 1.10 – 1.40 Kg/L (Batteries)	5 °C 0.01 Kg/L	Distilled water
			-40 a 0 °C (Cleaning)	10°C	
		HPK006	-50 a 0 °C (EG/PG) 1.15 – 1.30 sg (Batteries)	5 °C 0.01 seg	Distilled water

▶ HRB - Hand

▶ Folding handles



1 | With glass lens and plastic folding handle.

Code	Description	Diameter	Magnification
HRB008	1 lens	50 mm	3x

▶ Metal ring



1 | With black handle that can be separated from the rest of the magnifying glass. The lens is made of glass.

Code	Diameter	Magnification
HRB010	60 mm	6x
HRB011	75 mm	5x

page
[148]

▶ HRD - Desktop

▶ With clamps



1 | Small magnifying glasses with metalic structure and a pair of clamps to hold the object to be observed. The lens is made of glass.

Code	Diameter	Magnification
HRD001	60 mm	7x

▶ Desktop



1 | Metallic base and flexible arm to be fixed at the most adequate position.
2 | Large diameter glass lens.

Code	Diameter	Magnification
HRD002	92 mm	3x

▶ HRG - Thread counters



1 | Made in plastic, the thread counters presents a base graduated in millimeters and inches.

Code	Diameter	Magnification
HRG003	110 mm	3x
HRG004	50 mm	5x

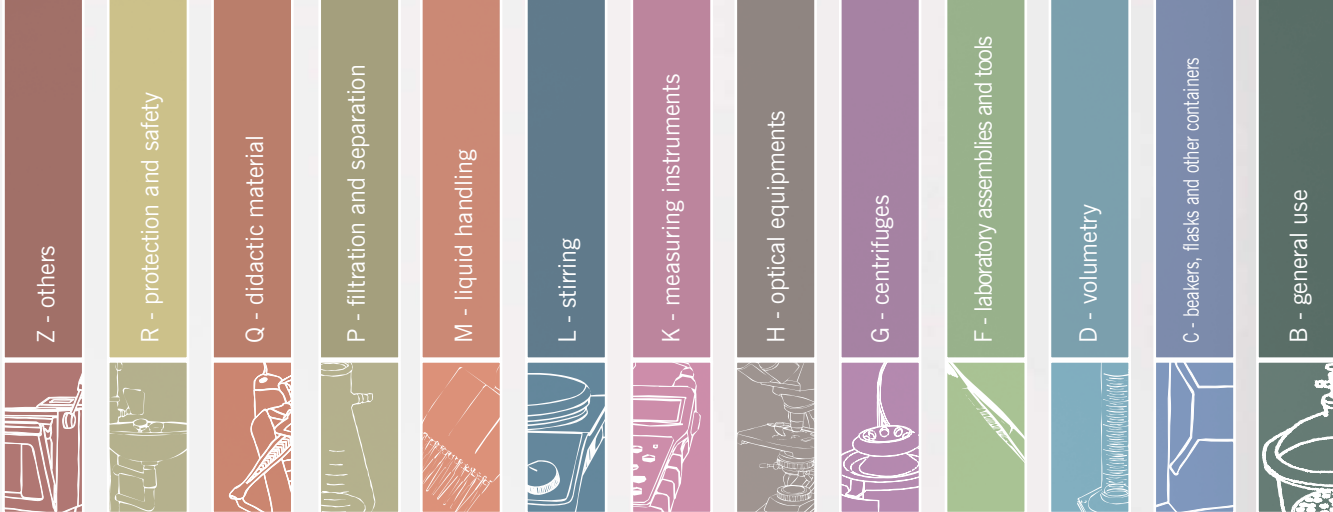

[J] INDEX OF CONTENTS HEATING - COOLING

[JB] Ovens..... 150
 JBB - Incubators150
 JBD - Drying ovens.....150
 JBG - Incubators/Drying ovens, accessories151

[JD] Baths..... 151
 JDB - Water/Oil baths, analogical151
 JDD - Water/Oil baths, digital.....151
 JDG - Water/Oil baths, accessories152
 JDS - Thermoblocks.....152
 JDV - Thermoblocks, accessories.....154

[JG] Heating mantles 155
 JGB - Mantles with stirring155
 JGD - Mantles without stirring.....155

TRADEMARKS:



JBB - Incubators



Incubator series 636 PLUS



- 1| Made of furnace painted steel, external metal structure covered with epoxy and interior of stainless steel
- 2| Door with double glazed window for external control without temperature variations in the inner chamber
- 3| Air circulation system by natural convection
- 4| Supplied with two height adjustable grid trays

Code	JBB005	JBB001	JBB002	JBB003	JBB004
Capacity	18 L	30 L	45 L	65 L	125 L
T range	RT+5-80°C				
Resolution	1°C (adjustable at 0.1°C)*				
T fluctuation	± 0.5 °C				
Homogeneity	2%				
Consumption	0.3 Kw	0.3 Kw	0.3 Kw	0.4 Kw	0.5 Kw
Aprox. dimensions (cm)					
External	44x38x55	46x51x69	50x55x73	55x55x84	64x68x91
Internal	26x26x26	31x31x31	35x35x35	40x36x45	50x45x55
Aprox. weight	20 Kg	39 Kg	42 Kg	53 Kg	58 Kg

* consult

JBD - Drying



Drying ovens natural convection, series 631 PLUS



- 1| External metal structure covered with epoxy and interior of stainless steel. Adjustable legs to facilitate installation and levelling of the oven
- 2| 180° opening door with double thermic safety glass window for external control, without temperature variations in the inner chamber
- 3| Air circulation system by natural convection (by density changes)
- 4| Supplied with two height adjustable grid trays

Code	JBD009	JBD001	JBD002	JBD003	JBD004
Capacity	18 L	30 L	45 L	65 L	125 L
T range	~80 - 250°C				
Resolution	1°C (adjustable at 0.1°C)*				
T fluctuation	± 1,0°C				
Homogeneity	3%				
Consumption	0.6 kW	0.8 Kw	1.0 Kw	1.5Kw	2.3Kw
Aprox. dimensions cm					
External	44x38x55	46x51x69	50x55x73	55x55x84	64x68x91
Internal	26x26x26	31x31x31	35x35x35	40x36x45	50x45x55
Aprox. weight	20 Kg	39 Kg	42 Kg	53 Kg	58 Kg

* consult

Drying ovens forced air, series 632 PLUS



- 1| Same as drying oven series 631 PLUS
- 2| Forced air circulation system with switch air circulation

Code	JBD005	JBD006	JBD007	JBD008
Capacity	30 L	45 L	65 L	125 L
T range	~80 - 250°C			
Resolution	1°C (adjustable at 0.1°C)*			
T fluctuation	± 1,0°C			
Homogeneity	2%			
Consumption	0.8 Kw	1.0 Kw	1.5Kw	2.3Kw
Aprox. dimensions cm				
External	46x51x69	50x55x73	55x55x84	64x68x91
Internal	31x31x31	35x35x35	40x36x45	50x45x55
Aprox. weight	39 Kg	42 Kg	53 Kg	58 Kg

JBG - Incubators-drying, accessories

CHART 1: 'accessories incubators and drying ovens'

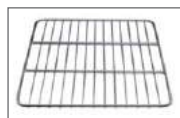

Code	Description	Model			
		30L	45L	65L	125L
JBG001	Tray 28x28 cm	i			
JBG002	Tray 32x32 cm		i		
JBG003	Tray 37x42 cm			i	
JBG004	Tray 47x42 cm				i
JBG005	Fastening guide	i			
JBG006	Fastening guide		i	i	
JBG007	Fastening guide				i

i Accessory **included** with the indicated equipment **□** = Accessory **compatible** with the indicated equipment

JDB - Water-oil analogical

For education RS 3.5

- 1| Polycarbonate tank, lacquered metal body and stainless steel heating device
- 2| Adjustable temperature, it has a safety thermostat
- 3| Rack SS (AISI 316) included: 20 tubesx Ø 16 mm.



Code	JDB001
Model	RS 3.5
Volume	3.5 Liters
Temperature	Environment +5°C > +90°C
Temperature regulation	Analogical
Operation indication	Yes
Consumption	350 W

JDD - Water-oil digital



Digital water bath

- 1| Inside chamber designed in stainless steel, made of a single piece free of welds, assembled to an external metallic structure covered with epoxy
- 2| Acoustic signal at the end of the selected time, in continuous mode operation or programmed periods
- 3| Acoustic signal that indicates overheating of the bath (> 5°C of the selected temperature)
- 4| Electric draining pump with drainpipe (except model 601/3)
- 5| Removable rack with holes, lid and reduction rings included

Code	JDD001	JDD002	JDD003	JDD004
Modelo	601/3	601/5	601/12	601/19
Capacity	2,5 L	5 L	12 L	19 L
T range	RT+5°C – 100°C			
Resolution	1 °C			
Timer	1' - 9 h 59'			
Holes	1	2	4	6
Aprox. useful dimensions(cm)	15x13x10	30x15x10	32x30x10	50x30x10
Aprox. weight	4 kg	7 kg	10 kg	7 Kg



▶ JDD - Water-oil digital



▶ Digital oil baths



- 1| Acoustic signal at the end of the selected time, in continuous mode operation or programmed periods
- 2| Acoustic signal that indicates overheating of the bath (>5°C of the selected temperature)
- 3| Removable rack with holes. Lid and reduction rings included

Code	JDD005	JDD006
Modelo	602/3	602/5
Capacity	3 L	5 L
Temperature range	RT+5°C – 200°C	RT+5°C – 200°C
Resolution	1°C	1°C
Timer	1'- 9 h 59'	1'- 9 h 59'
Holes	1	2
Aprox. useful dimensions	17x17x7 cm	32x17x7 cm
Aprox. weight	4 kg	7 kg

▶ JDG - Water-oil accessories



▶ Rings for waterbad



- 1| High resistance to acids and alkalines
- 2| Thermal conductivity 1.3

Code	Density	Maximum Ø
JDG001	2,4g/cm ³	145mm

▶ JDS - Thermoblock



▶ Mini 'T'



- 1| Compact design
- 2| Simultaneous display of actual and set time and temperature in the LCD screen
- 3| Several aluminum blocks available (not included) to cover a wide range of tubes (from 0.2 mL to 50 mL) and other type of containers

NOTE: Blocks not included, consult section: JDV-Thermoblocks accessories

Code	JDS001
Temperature range	RT+5- 80°C
Temperature control precision	0,5°C
Screen resolution	0,1°C
Heating time (20°C to max. T)	<12 min
Timer	0-999 seg o 0-999 min
Aprox. dimensions	110 x 150 x 80 mm
Aprox. weight	0,5 Kg

▶ JDS - Thermoblock

▶ Modelo 603/3

- 1) Simultaneous display of actual and set time and temperature in the LED screen
- 2) Several blocks available (not included) to cover a wide range of tubes (from 0.2 mL to 1.5 mL)

NOTE: Blocks not included, consult section: JDV-Thermoblocks accessories

Code	JDS002
Temperature range	RT+5- 100°C
Temperature control precision	±0,5°C
Screen resolution	0,1°C
Heating time (20°C to max. T)	<25 min
Timer	1 min – 99h 59min
Aprox. dimensions	225 x 160 x 197 mm
Aprox. weight	3 Kg



▶ Model 603/10 and 603/20

- 1) Simultaneous display of actual and set time and temperature in the LCD screen
- 2) Several blocks available (not included) to cover a wide range of tubes (from 0.2 mL to 2 mL)

NOTE: Blocks not included, consult section: JDV-Thermoblocks accessories

Code	JDS003	JDS004
Temperature range	RT+5 a 100°C	-10°C a 100°C
Temperature control precision	± 0,5 °C	± 0,5 °C
Screen resolution	0,1 °C	0,1 °C
Heating time (20°C to max. T)	<12 min	<20 min
Cooling time (20°C to -10°C)	<30 min	
Timer	1 min – 99h 59min	
Aprox. dimensions	300 x 210 x 180 mm	
Aprox. weight	2,5 Kg	4,6 Kg



▶ Thermoshaker, model 603/100

- 1) Simultaneous display of actual and set time, temperature and speed in the LCD screen
- 2) It can heat and shake simultaneously or work in independent mode
- 3) Several blocks available (not included) to cover a wide range of tubes (from 0.2 mL to 2 mL)

NOTE: Blocks not included, consult section: JDV-Thermoblocks accessories

Code	JDS005
Temperature range	RT +5 °C - 100°C
Temperature control precision	±0,5°C
Screen resolution	0,1°C
Heating time (20°C to max. T)	<20 min
Shaking speed	200-1500 rpm
Shaking orbit	2 mm
Timer	1 min – 99h 59min
Aprox. dimensions	354 x 240 x 170 mm
Aprox. weight	8,5 Kg





JDS - Thermoblock



▶ Thermoshaker for microtiter plates



- 1 | Simultaneous display of actual and set time, temperature and speed in the LCD screen
- 2 | It can heat and shake simultaneously or work in independent mode
- 3 | Capacity for 4 standard plates of 96 wells

Code	JDS006
Temperature range	RT+5- 60°C
Temperature control precision	±0,5°C
Screen resolution	0,1°C
Heating time (20°C to max. T)	<25 min
Shaking speed	100-1200 rpm
Shaking orbit	2 mm
Timer	1 min – 99h 59min
Aprox. dimensions	385 x 395 x 190 mm
Aprox. weight	9,5 Kg



JDV - Thermoblocks, accessories



▶ CHART 2: 'accessories thermoblocks'

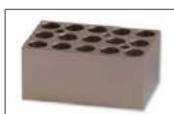

Code - JDV003



Code - JDV005



Code - JDV007



Code - JDV008-011



Code - JDV014



Code - JDV016

Code	Capacity	Model				
		Mini 'T'	603/3	603/10	603/20	603/100
JDV001	40 tubes of 0,2 ml	<input type="checkbox"/>				
JDV002	24 tubes of 0,5 ml	<input type="checkbox"/>				
JDV003	15 tubes of 1,5 ml	<input type="checkbox"/>				
JDV004	15 tubes of 2 ml	<input type="checkbox"/>				
JDV005	8 cells of 12,5x12,5 mm	<input type="checkbox"/>				
JDV006	4 tubes of 15 ml	<input type="checkbox"/>				
JDV007	2 tubes of 50 ml	<input type="checkbox"/>				

Code	Capacity	Model				
		Mini 'T'	603/3	603/10	603/20	603/100
JDV008	96 microtubes of 0,2 ml			<input type="checkbox"/>	<input type="checkbox"/>	<input type="checkbox"/>
JDV009	54 microtubes of 0,5 ml			<input type="checkbox"/>	<input type="checkbox"/>	<input type="checkbox"/>
JDV010	35 microtubes of 1,5 ml			<input type="checkbox"/>	<input type="checkbox"/>	<input type="checkbox"/>
JDV011	35 microtubes of 2 ml			<input type="checkbox"/>	<input type="checkbox"/>	<input type="checkbox"/>

Code	Capacity	Model				
		Mini 'T'	603/3	603/10	603/20	603/100
JDV012	96 tubes of 0,2 mL		<input type="checkbox"/>			
JDV013	29 tubes of 0,5 mL		<input type="checkbox"/>			
	32 tubes of 1,5 mL		<input type="checkbox"/>			
JDV014	61 tubes of 0,5 mL		<input type="checkbox"/>			
JDV015	41 tubes of 1,5 mL		<input type="checkbox"/>			
JDV016	28 tubes of 12 mm Ø		<input type="checkbox"/>			

= Accessory included with the indicated equipment = Accessory compatible with the indicated equipment

▶ JGB - With stirring

▶ Analogical with stirring, series 656

- 1| External structure in painted steel and inside thermal isolation with rock wool, they have heating elements in nickelchrome
- 2| Maximum stirring speed: 1400 rpm
- 3| Maximum T: 370°C
- 4| Supplied with rod, support and stirring magnet

Code	Capacity	Internal Ø	Depth
JGB001	100 mL	70 mm	45 mm
JGB002	250 mL	90 mm	55 mm
JGB003	500 mL	105 mm	60 mm
JGB004	1000 mL	140 mm	85 mm



▶ Digital with stirring, series 658

- 1| External structure in painted steel and inside thermal isolation with rock wool, they have heating elements in nickelchrome
- 2| Analogical speed adjustment through potentiometer and digital temperature adjustment with LED screen
- 3| Maximum stirring speed: 1400 rpm
- 4| Maximum T: 370°C
- 5| Supplied with rod, support and stirring magnet

Code	Capacity	Internal Ø	Depth
JGB005	250 mL	90 mm	55 mm
JGB006	500 mL	105 mm	60 mm
JGB007	1000 mL	140 mm	85 mm
JGB008	2000 mL	180 mm	105 mm



▶ JGD - Without stirring

▶ Analogical, series 655

- 1| External structure in painted steel and inside thermal isolation with rock wool, they have heating elements in nickelchrome
- 2| It has a device to hold rods
- 3| Maximum T: 370°C

Code	Capacity	Internal Ø	Depth
JGD001	50 mL	55 mm	40 mm
JGD002	100 mL	70 mm	45 mm
JGD003	250 mL	90 mm	55 mm
JGD004	500 mL	105 mm	60 mm
JGD005	1000 mL	140 mm	85 mm
JGD006	2000 mL	180 mm	105 mm
JGD007	3000 mL	210 mm	115 mm
JGD008	5000 mL	240 mm	140 mm



LABORATORY
SUPPLIERS

SERVICES

TRADEMARKS

STOCK

COMPETITIVITY



 **IENDO**
plasticware

Own brand of the group Auxilab/ Rogo Sampaic.
Please know the wide range of laboratory plastic
products we offer at your disposal. Plastic of quality at
a competitive price to satisfy your needs



[K] INDEX OF CONTENTS MEASURING INSTRUMENTS

[KB] Balances.....	158	[KK] Time	176
KBB - Electronic, precision 1/0.1 g	158	KKB - Stopwatches	176
KBC - Electronic, precision 0.01 g	159	KKF - Timers	177
KBD - Electronic, precision 0.001 g	160	[KL] Hydrometers	177
KBF - Analytical, precision 0.0001 g	161	KLB - Alcoholometers	177
KBH - Pocket.....	162	KLD - Areometers	177
KBN - Weighing accessories	162	KLG - Hydrometers	178
KBP - Spring balances	163	KLJ - Saccharometers.....	178
KBQ - Mechanical balances	163	KLL - Mustimeters	179
KBR - Mechanical, set of weights	164	KLN - Liquid hydrometers	179
KBS - Weights E2	165	KLQ - Pycnometers	179
KBT - Weights F1	166	[KN] Viscosimeters	179
KBV - Weights F2	166	KNB- Rotational viscosimeters.....	179
KBW - Weights M1	167	[KZ] Others.....	181
[KD] pH-meters	167	KZB - Dissolved oxygen	181
KDB - Testers	167	KZD - Multiparameter.....	182
KDD - Laboratory pH-meters	168		
KDG - Electrodes and accessories	169		
KDJ - pH paper	170		
[KG] Conductivity meters	170		
KGB - Testers	170		
KGD - Laboratory conductivity-meters	171		
KGG - Conductivity cells/Accessories	173		
[KJ] Thermometers.....	173		
KJB - Solid stem.....	173		
KJD - Enclosed scale.....	173		
KJJ - With metal probe.....	174		
KJM - Room temperature.....	174		
KJP - For refrigerators.....	175		
KJR - Others	176		

TRADEMARKS:





MEASURING INSTRUMENTS BALANCES



AUTOMATIC INTERNAL ADJUSTMENT:
Adjustment through internal calibration weight driven by motor



ADJUSTING PROGRAM CAL.:
An external calibration weight is needed



DATA INTERFACE RS-232:
To connect the equipment with a printer, computer or net



USB:
To connect the equipment with a printer, computer u other peripheral



PIECE COUNTING:
Selectable number of referen- ces. To switch the display from piece to weight



PERCENTAGE DETERMINATION:
Deviation determination in % from theoretical value (100%)



WEIGHTING UNITS:
By pushing unit button



UNDER WEIGHTING:
By a hook in the underside of the balance



POWER SUPPLY BY ACCUMULATOR



POWER SUPPLY BY BATTERIES:
For operation with batteries, the type of battery is indicated in each device



CURRENT ADAPTER:
110/220V of standard series in the EU



SUPPLY CABLE:
Integrated in the balance 230V/50Hz standard in the EU



STRAIN GAUGES



ELECTROMAGNETIC FORCE COMPENSATION:
coil inside a permanent magnet, for more precise weighting



KBB - Electronical, precision 1-0.1g

Series 5161



- 1 | High precision load sensor
- 2 | Easy reading wide LCD screen with back light
- 3 | Plastic shell and stainless steel pan
- 4 | Weighting units and piece counting functions
- 5 | Automatic calibration with external weight (see table), weight only included in model KBB004
- 6 | With integrated rechargeable battery



Code	KBB004	KBB005	KBB006	KBB007
Max. capacity (g)	1000	2000	3000	5000
Readability (g)	0.1	0.1	0.1	0.1
Pan size (mm)	143x192			
Weighting units	g, kg, ct, T, TAR, dr, PKT, GN, TMR, gsm, tL, mo, dwt, oz, lb, tL, ozT, tLH, %			
Calibration weight (kg)	0.5 (included)	1 (not included)	2 (not included)	2 (not included)
Dimensions (mm)	280x180x80			
Power supply	110-220VAC, 50/60Hz			

▶ KBB - Electronical, precision 1-0.1g

▶ Series 5041



- 1| Very economic, ideal for domestic and educational use
- 2| ABS plastic shell and easy reading digital screen
- 3| Airtight water splash-proof keyboard
- 4| Automatic calibration with external weight (not included)

Code	KBB001	KBB002	KBB003*
Capacity (g)	500	2000	5000
Readability (g)	0.1	1.0	2.0
Pan size (mm)	Ø 148		
Weighting units	g, oz		
Dimensions (mm)	170x250x45		
Power supply	Adapter AC220V / 4 battery 1.5V (AA)		

*Battery and adapter not included (adapter not available)



▶ Series 5171



- 1| High precision load sensor and overload protection
- 2| Easy reading wide LCD screen with back light
- 3| Plastic shell and stainless steel pan
- 4| Functions of weighting units, piece counting and hook for underside weighting
- 5| Automatic calibration with external weight, weight included only in code KBB008



Code	KBB008	KBB009	KBB010	KBB011
Max. capacity (g)	1000	2000	3000	5000
Readability (g)	0.1	0.1	0.1	0.1
Pan size (mm)	Ø 135	Ø 135	155x143	155x143
Weighting units	g, oz, ct, lb			
Calibration weight (kg)	0.5 (included)	1 (not included)	2 (not included)	2.5 (not included)
Dimensions (mm)	265x200x80			
Power supply	AC110-220V / 4 battery 1.5V (AA) (not included)			



▶ KBC - Electronical, precision 0.01 g

▶ Serie 5162



- 1| High precision load sensor. Wide LCD screen with back light
- 2| Plastic shell and stainless steel pan
- 3| Weighting units and piece counting functions
- 4| Automatic calibration with external weight except code KBC004
- 5| With integrated rechargeable battery



Code	KBC001	KBC002	KBC003	KBC004
Max. capacity (g)	300	500	1000	2000
Readability (g)	0.01	0.01	0.01	0.01
Pan size (mm)	133x182			
Weighting units	g, kg, ct, T, TAR, dr, PKT, GN, TMR, gsm, tL, mo, dwt, oz, lb, tIT, ozt, tIH, %			
Calibration weight (kg)	0.2 (included)	0.5 (included)	0.5 (included)	1 (not included)
Dimensions (mm)	280x180x80			
Power supply	110-220VAC, 50/60Hz			



▶ KBC - Electronical, precision 0.01 g

▶ Series 5172



- 1 | High precision load sensor and overload protection
- 2 | Easy reading wide LCD screen with back light
- 3 | Plastic shell and stainless steel pan
- 4 | Functions of weighting units, piece counting and hook for underside weighting
- 5 | Automatic calibration with external weight, weight included except in codes KBC008 and KBC009



Code	KBC005	KBC006	KBC007	KBC008	KBC009
Max. capacity (g)	300	500	1000	3000	5000
Readability (g)	0.01	0.01	0.01	0.01	0.01
Pan size (mm)	Ø135	Ø135	Ø135	155x143	155x143
Weighting units	g, oz, ct, lb				
Calibration weight (kg)	0.2 (Incl.)	0.5 (Incl.)	0.5 (Incl.)	2 (not incl.)	3 (not incl.)
Dimensions (mm)	265x200x80				
Power supply	110-220VAC / 4 battery 1.5V (AA) (not included)				

▶ KBD - Electronic, precision 0.001 g



▶ Series 5133



- 1 | Electromagnetic force compensation technology
- 2 | Adjustment of the sensitivity level and weighting speed
- 3 | Overload protection
- 4 | Easy reading wide LCD screen with back light
- 5 | Aluminum shell and stainless steel pan
- 6 | Functions of weighting units, piece counting, percentage and hook for underside weighting
- 7 | Automatic calibration with external weight (included). RS232 and USB ports

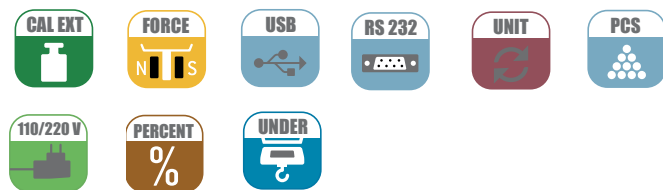

Code	KBD001	KBD002	KBD003
Precision class		Class II	Class II
Max. capacity (g)		100	300
Min. capacity (g)		20	20
Readability (g)		0.001	0.001
Scale verification value (g)			0.01
Repeatability (g)			±0.001
			0 ≤ m ≤ 5000
			5000 ≤ m ≤ 20000
			20000 < m
Stabilization time (s)			≤5
Pan size (mm)			Ø 90
Weighting units			g, mg, ct, oz
Calibration weight (kg)	0,1		0,2
Total dimensions (mm)			340x215x350
Power supply			110-220VAC, 50/60Hz

▶ KBD - Electronic, precision 0.001 g



▶ Series 5173

- 1| High precision load sensor and overload protection
- 2| Plastic shell and stainless steel pan
- 3| Easy reading wide LCD screen with back light
- 4| Functions of weighting units, piece counting and hook for underside weighting
- 5| Automatic calibration with external weight (included)
- 6| RS232 and USB ports

Code	KBD004	KBD005
Max. capacity (g)	100	300
Readability (g)	0.001	0.001
Repeatability (g)	±0.002	±0.002
Linearity (g)	±0.002	±0.002
Error (g)	±0.002	±0.002
Stabilization time (s)	1-1.5	
Pan size (mm)	90	
Weighting units	g, ct, oz, lb, ozt	
Calibration weight (kg)	0.05 (included)	0.2 (included)
Total dimensions (mm)	295x192x280	
Power supply	220-240VAC/50Hz	



▶ KBF - Analytical, precision 0.0001 g



▶ Series 5134

- 1| Electromagnetic force compensation technology
- 2| Adjustment of the sensitivity level and weighting speed
- 3| Overload protection
- 4| Easy reading wide LCD screen with back light
- 5| Aluminum shell and stainless steel pan
- 6| Functions of weighting units, piece counting, percentage and hook for underside weighting
- 7| Automatic calibration with external weight (included) or internal depending on model
- 8| RS232 and USB ports

Series 5134 EX; External calibration	KBF001	KBF003
Serie 5134 INT; Internal calibration	KBF002	KBF004
Precision class	Clase I	Clase I
Max. capacity (g)	120	220
Min. capacity (g)	10	10
Readability (g)	0.0001	0.0001
Scale verification value (g)	0.001	
Repeatability (g)	±0.0002	
	±0.5e	
	±1.0e	
	±1.5e	
Stabilization time (s)	≤8	
Pan size (mm)	Ø 80	
Weighting units	g, mg, ct, oz	
Total dimensions (mm)	340x215x350	
Power supply	110-220VAC, 50/60Hz	



Calibration certificate ENAC

Code	KBF005
Description	Certificate ENAC analytical balances

▶ KBH - Pocket balances



▶ Series 5043



- 1 | Compact and resistant design with protective lid
- 2 | Touch screen with back light for easy reading
- 3 | Stainless steel weighting pan
- 4 | Functions of weighting units, piece counting and tare with direct access button
- 5 | Calibration in one point (calibration weight not included)

Code	KBH001	KBH002	KBH003
Capacity (g)	100	200	500
Readability (g)	0.01	0.01	0.1
Pan size (mm)	60x60		
Weighting units	g, ct, dwt, oz, ozt		
Calibration weight	0,1 kg	0.2 kg	-
Dimensions (mm)	70x115x20		
Power supply	2 batteries 1.5 V (AAA)		

▶ KBN - Weighting accessories

▶ Watch glass ground edge



Code	Diameter (mm)	Batch
KBN001	45	10
KBN002	50	10
KBN003	60	10
KBN004	70	10
KBN005	80	10
KBN006	90	10
KBN007	100	10
KBN008	120	10
KBN009	150	10
KBN010	180	10

▶ Watch glass burnt edge



Code	Diameter (mm)	Batch
KBN011	40	10
KBN012	50	10
KBN013	60	10
KBN014	70	10
KBN015	80	10
KBN016	100	10
KBN017	120	10
KBN018	140	10
KBN019	160	10

▶ Weighing boat



- 1 | In porcelain. Without handle

Code	Description	Dim. (mm)	Batch
KBN020	Witouht handle	37/17 mm	10
KBN021	Witouht handle	53/23 mm	10
KBN022	Witouht handle	64/29 mm	10

▶ KBN - Weighing accessories

▶ Weighing paper

Code	Dimensions (mm)	Pack
KBN048	100X100 mm	P/100

▶ KBP - Dynamometers



▶ Plastic

- 1 | Calculation of mechanic type forces. Double scale in grams and newtons
- 2 | Keeps precision with time

Code	Range	Sensitivity	Batch
KBP003	250g / 2.5N	5g / 0.05N	10
KBP004	500g / 5N	10g / 0.1N	10
KBP005	1000g / 10N	20g / 0.2N	10
KBP006	2000g / 20N	50g / 0.5N	10
KBP007	3000g / 30N	50g / 0.5N	10
KBP008	5000g / 50N	100g / 1N	10



▶ KBQ - Mechanical



▶ Roverbal series 5001

- 1 | Made of furnace painted steel with treated steel blades and agate bearings
- 2 | Frontal scale for 5g to 50g additions (depending on model)
- 3 | Weights set included

Code	KBQ003	KBQ004
Capacity (g)	1000	2000
Readability (g)	1	2
Scale range (g)	0-10	*
Scale division (g)	1	-
Pan size (mm)	Ø 134	Ø 170
Dimensions (cm)	35x14x20	40x18x30

* without frontal scale



Mod. KBQ003

Mod. KBQ004

▶ Equal-arm balance series 5004

- 1 | Weighting system in steel with blades of treated steel and blocking system
- 2 | Detachable for storage (wooden box included)
- 3 | Complete set of weights included

Code	KBQ005
Capacity (g)	100
Sensitivity (g)	0.02
Pan size (mm)	Ø 80
Dimensions (mm)	300x160x80



▶ KBQ - Mechanical



▶ 4 beams



- 1 | Cast light metal, with agate bearings and blades of tempered steel
- 2 | It has 4 beams with sliding weights of 100g, 10g, 1g and 0.1g
- 3 | With platform to make hydrostatic weightings

Code	KBQ006
Capacity (g)	311
Sensitivity (g)	0.01
1ª beam	1g divided every 0.01g
2ª beam	10g divided every 1g
3ª beam	100g divided every 10g
4ª beam	200g divided every 100g
Pan size (mm)	Ø100
Dimensions (mm)	420x180x360

▶ 3 beams



- 1 | Cast light metal, with agate bearings and tempered steel blades
- 2 | It has 3 beams with sliding weights
- 3 | It incorporates a support for additional weights supplied with the equipment:
 - 2 weights of 295g that increase the capacity in 1000g
 - 1 weight of 147.5g that increase the capacity in 500g

Code	KBQ007
Capacity (g)	610 2610, with additional weights
Sensitivity (g)	0.1
1ª beam	10g divided every 0.1g
2ª beam	500g divided every 100g
3ª beam	100g divided every 10g
Pan size (mm)	Ø10
Dimensions (mm)	420x180x360

▶ KBR - Mechanical, sets of weights



- 1 | Made of A3 steel class M2
- 2 | Usually used with mechanical balances
- 3 | Supplied in a case

Code	KBR001
Description	Set of weights of 200g
Composed of	1 weight of 100g 1 weight of 50g 2 weights of 20g 1 weight of 10g 1 weight of 5g 1 forceps



Code	KBR002
Description	Set of weights of 500g
Composed of	1 weight of 200g 2 weights of 100g 1 weight of 50g 2 weights of 20g 1 weight of 10g 1 forceps

▶ KBR - Mechanical, sets of weights



Code	KBR003
Description	Set of weights of 1000g
Composed of	1 weight of 500g 1 weight of 200g 2 weights of 100g 1 weight of 50g 2 weights of 20g 1 weight of 10g



Code	KBR004
Description	Set of weights of 2000g
Composed of	1 weight of 1kg 1 weight of 500g 1 weights of 200g 2 weights of 100g 1 weight of 50g 2 weights of 20g 1 weight of 10g



▶ KBS - Weights E2



- 1| Control and high precision calibration weights for high resolution balances class I with a maximum resolution higher than 100000 d
- 2| Made of antimagnetic stainless steel
- 3| Supplied in individual storage boxes

Code	Weight (nominal value)	Tolerance (mg)
KBS002	1 g	± 0.03
KBS003	2 g	± 0.04
KBS004	5 g	± 0.05
KBS005	10 g	± 0.06
KBS006	20 g	± 0.08
KBS007	50 g	± 0.10
KBS008	100 g	± 0.15
KBS009	200 g	± 0.30
KBS010	500 g	± 0.75
KBS011	1 Kg	± 1.50
KBS012	2 Kg	± 3.00
KBS013	5 Kg	± 7.50
KBS014	10 Kg	± 15.00
KBS015	20 Kg	± 30.00
KBS001	Set of 12 fractions from 500 mg to 1 mg**	-----

** Set of fractions: 1x1mg, 2x2mg, 1x5mg, 1x10mg, 2x20mg, 1x50mg, 1x100mg, 2x200mg and 1x500mg.



Calibration certificate ENAC

Code	KBS016
Description	Certificate of masses ENAC E2, for weights E2 of 1 mg to 500g



KBT- Weights F1



- 1 | High precision weights for the control calibration and adjustment of analytical balances class I, with a maximum resolution higher than 100000 d
- 2 | Made of stainless steel
- 3 | Supplied in individual storage boxes



Code	Weight (nominal value)	Tolerance (mg)
KBT002	1 g	± 0.10
KBT003	2 g	± 0.12
KBT004	5 g	± 0.15
KBT005	10 g	± 0.20
KBT006	20 g	± 0.25
KBT007	50 g	± 0.30
KBT008	100 g	± 0.50
KBT009	200 g	± 1.00
KBT010	500 g	± 2.50
KBT011	1 Kg	± 5.00
KBT012	2 Kg	± 10.00
KBT013	5 Kg	± 25.00
KBT014	10 Kg	± 50.00
KBT015	20 Kg	± 100.00
KBT001	Set of 12 fractions from 500 mg to 1 mg**	-----

** Set of fractions: 1x1mg, 2x2mg, 1x5mg, 1x10mg, 2x20mg, 1x50mg, 1x100mg, 2x200mg a 1x500mg.

Calibration certificate ENAC

Code	KBT016
Description	Certificate of masses ENAC F1 from 1 mg to 10 kg



KBV- Weights F2



- 1 | High precision weights suitable for high precision balances class II, with a maximum resolution up to 50000 d aprox.
- 2 | Made of stainless steel
- 3 | Supplied in individual storage boxes



Code	Weight (nominal value)	Tolerance (mg)
KBV002	1 g	± 0.3
KBV003	2 g	± 0.4
KBV004	5 g	± 0.5
KBV005	10 g	± 0.6
KBV006	20 g	± 0.8
KBV007	50 g	± 1.0
KBV008	100 g	± 1.5
KBV009	200 g	± 3.0
KBV010	500 g	± 7.5
KBV011	1 Kg	± 15.0
KBV012	2 Kg	± 30.0
KBV013	5 Kg	± 75.0
KBV014	10 Kg	± 150.0
KBV015	20 Kg	± 300.0
KBV001	Set of 12 fractions from 500 mg to 1 mg**	-----

** Set of fractions: 1x1mg, 2x2mg, 1x5mg, 1x10mg, 2x20mg, 1x50mg, 1x100mg, 2x200mg and 1x500mg.

Calibration certificate ENAC

Code	KBV016
Description	Certificate of masses ENAC F2, from 1 mg to 10 kg

KBW- Weights M1



- 1 | Precision weights for commercial and industrial balances class III, with a maximum resolution up to 1000 d
- 2 | Made of A3 steel
- 3 | Supplied in individual storage boxes



Code	Weight (nominal value)	Tolerance (mg)
KBW001	Juego 12 fracciones de 500mg a 1mg**	-----
KBW002	1 g	± 1.0
KBW003	2 g	± 1.2
KBW004	5 g	± 1.5
KBW005	10 g	± 2.0
KBW006	20 g	± 2.5
KBW007	50 g	± 3.0
KBW008	100 g	± 5.0
KBW009	200 g	± 10.0
KBW010	500 g	± 25.0
KBW011	1 Kg	± 50.0
KBW012	2 Kg	± 100.0
KBW013	5 Kg	± 250.0
KBW015	10 Kg	± 500.0
KBW017	20 Kg	± 1000.0

** Set of fractions: 1x1mg, 2x2mg, 1x5mg, 1x10mg, 2x20mg, 1x50mg, 1x100mg, 2x200mg and 1x500mg.

Calibration certificate ENAC

Code	KBW019
Description	Certificate of masses ENAC M1, from 1 mg to 10 kg

Weights M1, block

- 1 | According to standard OIML-R111
- 2 | Made of painted cast iron
- 3 | Density 7.02 g/cm³.

Code	Weight (nominal value)	Tolerance (mg)
KBW014	5 Kg	±250
KBW016	10 Kg	±500
KBW018	20 Kg	±1000



KDB - Pocket testers



pH-tester

- 1 | Ideal for practical lessons in the lab and field
- 2 | Integrated fixed electrode
- 3 | With two point calibration

Code	KDB001	KDB002
Range	0-14 pH	0-14 pH
Resolution	0.1 pH	0.1 pH
Precision	± 0.1 pH	± 0.1 pH
ATC	No	5-50 °C
Platform dimensions (mm)	150x29x15	
Power supply	4 batteries x 1.5V	



▶ KDD - Laboratory pH-testers

▶ Portable pH-tester model 902/4



Nahita

- 1 | Liquid crystal display and damp-proof membrane keypad
- 2 | Supplied with a glass combined electrode with BNC connector
- 3 | Automatic temperature compensation by manual data input

Code	KDD001
pH range	0.0 a 14.0 pH
mV range	0 - ±1400 mV
pH-mV resolution	0.01 pH - 1 mV
pH-mV precision	± 0.03 pH - ± 0.2%
ATC range	0-60 °C (Manual)
Calibration	1 or 2 points
Power supply	2 batteries 5V

▶ Digital pH-testers models 903 and 907

Nahita



REF. KDD002



Mod. KDD006

- 1 | Large easy-to-read back lit LCD display
- 2 | Measuring parameters of pH at compensated temperature and electrical potential (mV)
- 3 | 1 or 2 point calibration with automatic detection of standard solution
- 4 | Automatic temperature compensation through the keypad (903) or probe (907)
- 5 | Suitable to use with ion selective electrodes
- 6 | Built-in electrode support
- 7 | RS232 port and data transmission software (907)

Code	KDD002	KDD006
Model	903	907
Measuring range		
pH	0-14.0 pH	-2.00-18.00 pH
mV	±1999 mV	±1999 mV
T	---	0/100 °C (probe included)
Resolution	0.01 pH - 1 mV	0.01 pH - 1 mV - 0.1 °C
Precision		
pH	±0.02 pH ± 1bit	±0.02 pH ± 1 bit
mV	±1 mV ± 1bit	±1 mV ± 1bit
T	---	±0.5°C ± 1 bit (0.0-60.0°C) ±1.0°C ± 1 bit (60.0-100.0°C)
ATC range	0-60 °C (±0.01 pH)	0-100 °C (±0.01 pH)
Stability	± 0.01 pH ± 1 bit/3 h	± 0.01 pH ± 1 bit/3 h
Dimensiones	290x210x95 mm	290x200x70 mm
Power supply	CA (220±22)V / (50±1) Hz	220VAC/9V

▶ Soil pH and moisture meters

Nahita



Mod. KDD004

- 1 | Portable and resistant for use in agriculture and gardening
- 2 | Built-in sensor in the conical end
- 3 | Do not need power supply

Code	KDD004
pH range	3-8 pH
Moisture range (%)	1-8 (10-80%)
pH resolution - %	0.2 pH - 10%
Probe	Fixed (30cm)
Dimensions (mm)	410x50

▶ KDD - Laboratory pH-testers



▶ pH-ppm-temperature monitor

- 1| Monitor for the continuous measuring of pH, TDS and temperature (T)
- 2| It includes combined electrode of pH and conductivity cell with integrated temperature probe
- 3| With automatic temperature compensation (ATC) in the 5-50°C range

Code	KDD005			
Parameter	Range	Resolution	Precision	Calibration
pH	0.00-14.00 pH	0.01 pH	± 0.10 pH	2 points (7.00/4.01 pH)
TDS	0-9990 ppm	10 ppm	± 2% ppm	1 point (1382 ppm)
T	5-35 °C	1 °C	± 1°C	1 point (25°C/77 °F)
Dimensions	85x165x30 mm			
Power supply	Adapter CA, 9V (included)			



▶ KDG - Electrodes and accessories



▶ Electrode stand

- 1| Arm articulated in 3 points and rotatable 360°
- 2| Painted steel base of great stability
- 3| Holder with 1 central hole and 5 lateral slots

Code	KDG001
Nº x holes Ø	1 x 6mm - 5 x 14mm



▶ pH buffers

- 1| Powder preparation to obtain pH buffer solutions (acid, basic, neutral)
- 2| A correlation Temperature/pH table is included

Code	KDG002
pH buffer	Acid, basic and neutral
Precision	± 0.01 pH



▶ pH electrodes

- 1| Measuring pH range 0 to 14
- 2| Available with glass or plastic body
- 3| Options of refillable (liquid electrolyte) or non-refillable (gel electrolyte)
- 4| Fixed cable with BNC connector

Plastic body

Code	KDG003
Working T (°C)	5-60
Diaphragm	Fiber
Ø x L (mm)	12x165
Membrane	Spherical
Electrolyte	Gel, non-refillable



Glass body

Code	KDG005
Working T (°C)	5-60
Diaphragm	Ceramic
Ø x L (mm)	12x148
Membrane	Spherical
Electrolyte	Refillable liquid



KDG - Electrodes and accessories



Power supply

- 1 | For pH-meter 907 and conductivity meter 910/9
- 2 | It includes plug suitable for Europe, Great Britain and USA

Code	KDG011
Description	Power supply 100-240VAC/9V

KDJ - pH paper



Universal



- 1 | With approximate pH value indicator colour scale

Code	pH range	Scale	Format
KDJ002	1-10	1	Box 200 strips
KDJ003	0-10	1	Roll 5 meters
KDJ004	1-12	1	Box 200 strips
KDJ005	1-14	1	Box 200 strips
KDJ007	1-14	1	Box 80 strips
KDJ006	1-14	1	Roll 5 meters
KDJ001	1-4	1	Box 200 strips
KDJ009	9-14	1	Box 200 strips

Indicator



- 1 | The colour change of the paper indicates the pH range of the solution
- 2 | Available in box of 200 strips

Code	Description	Colour change
KDJ016	Red litmus	basic pH (blue)
KDJ019	Blue litmus	acid pH (red)
KDJ020	Neutral litmus (violet)	acid pH (red)-basic pH (blue)

KGB - Pocket testers



TDS-meter



- 1 | Splash-proof shell
- 2 | They present automatic temperature compensation (ATC)

Code	KGB003	KGB004	KGB005	KGB007
Range	0-1999 μ S/cm	0-19.99 mS/cm	0-1999 ppm (mg/L)	0-10.0 EC
Resolution	1 μ S/cm	0.01 mS/cm	1 ppm (mg/L)	0.1 EC
Precision	\pm 2% (full scale)			
ATC range	0-50 $^{\circ}$ C			
Calibration	In 1 point by manual adjustment			
Dimensions	150x32x16 mm			
Power supply	4 batteries x 1.5V			

▶ KGB - Pocket testers



▶ Mini TDS-meter

- 1| Compact and reliable instruments recommended for education
- 2| They provide readings of conductivity and dissolved solids (TDS)
- 3| They present automatic temperature compensation (ATC)

Code	KGB008	KGB010
Range	0-100 cF	0-1999 ppm (mg/L)
Resolution	1 cF	1 ppm (mg/L)
Precision	± 2% (full scale)	
ATC range	0-50 °C	
Calibration	In 1 point by manual adjustment	
Dimensions	150x32x16 mm	
Power supply	4 battery x 1.5V	



▶ KGD - Laboratory conductivity meters



▶ Portable conductivity meter model 910/3

- 1| Conductivity parameter determination
- 2| Back-lit LCD display and splash- and moisture-proof membrane keypad
- 3| Automatic temperature compensation (ATC) through keypad data input
- 4| Cell constant adjustable for values 0.01, 1 and 10 cm⁻¹
- 5| Supplied with platinum conductivity cell (K=1 cm⁻¹)

Code	KGD001
Conductivity	
Range	0.00-19.99 μS/cm; 20.0-199.9 μS/cm; 200-1999 μS/cm; 2000-19000 μS/cm; 20.0-100.0 mS/cm
Resolution	0.01 μS/cm; 0.1 μS/cm; 1 μS/cm; 1 μS/cm; 0.1 mS/cm
Precision (± 1 digit)	± 1.5%
ATC range	15-35 °C (data inputting through keypad)
T coefficient	2 % / °C (fixed)
Reference T	25 °C
Dimensions	170x80x35 mm
Power supply	2 batteries 1.5V, type AA



▶ KGD - Laboratory conductivity meters



▶ Portable conductivity meter model 910/5



- 1 | Conductivity, total dissolved solids (TDS) and salinity parameters determination
- 2 | Back-lit LCD display and splash- and moisture-proof membrane keypad
- 3 | Automatic temperature compensation (CAT) through built-in T probe
- 4 | Cell constant adjustable for values 0.01, 0.1, 1, 5 and 10 cm⁻¹
- 5 | Supplied with platinum conductivity cell (K=1 cm⁻¹)
- 6 | RS232 port for PC or printer connection
- 7 | Supplied with storage and transport case

Code	KGD002
Conductivity	
Range	0.00-19.99 μS/cm; 20.0-199.9 μS/cm; 200-1999 μS/cm; 2.00-19.99 mS/cm; 20.0-199.9 mS/cm
Resolution	0.01 μS/cm; 0.1 μS/cm; 1 μS/cm; 0.01 μS/cm; 0.1 mS/cm
Precision (± 1 dígito)	± 1.5 %
Total dissolved solids (TDS)	
Range	0.00-10.00 mg/L; 10.0-100.0 mg/L; 100-1000 mg/L; 1.00-10.00 g/L; 10.00-19.99 g/L
Resolution	0.01 mg/L; 0.1 mg/L; 1 mg/L; 0.01 g/L; 0.01 g/L
Precision (± 1 dígito)	± 1.5 %
Salinity	
Range	0.00-8.00 %
Resolution	0.01 %
Precision (± 1 dígito)	± 0.3 %
T range	0.0-40.0 °C
T coefficient	0-4 %/°C (default 2 %/°C)
Reference T	25 °C (conductivity and TDS) and 18 °C (salinity)
Factor conversión TDS	0.40-1.00 (default 0.50)
Dimensions	210x100x45 mm
Power supply	4 batteries 1.5V (AA)

▶ Laboratory conductivity meter 910/9



- 1 | Determination of conductivity, resistivity, TDS, salinity and temperature
- 2 | Large back-lit LCD display and membrane keypad
- 3 | Automatic temperature compensation (ATC) through keypad or built-in T probe
- 4 | Cell constant adjustable for values 0.01, 0.1, 1, 5 and 10 cm⁻¹
- 5 | Supplied with platinum conductivity cell (K=1 cm⁻¹)
- 6 | Use under GLP rules
- 7 | USB output for computer connection through communication software

Code	KGD003
Measuring range	
Conductivity	0.000 μS/cm – 199.9mS/cm (automatic change of range and frequency)
Resistivity	5.00 Ω•cm – 20.00 MΩ•cm
TDS	0.000 mg/L – 99.9 g/L
Salinity	(0.00-8.00) %
Temperature	(-5.0 – 110.0) °C
Electrical unit precision	
Conductivity	±0.5% FS
Resistivity	±0.5% FS
TDS	±0.5% FS
Salinity	± 0.1%
Temperature	±0.2°C
T compensation	Auto/Manual: -5.0 – 50.0 °C
Stability	±0.3%FS/3h
T coefficient	Adjustable
GLP rules	Yes
Output	USB port
Working conditions	0-40 °C, ≤ 85% HR
Power supply	Adapter 100-240 V / 9 V DC
Dimensiones	280x215x92 mm

KGG - Conductivity cells



- 1| Body glass resistant to corrosion and organic solvents
- 2| With 2 platinum electrodes
- 3| BNC connector with 60cm length fixed cable

KGG003	Cell conductivity K=1	
	Constant	Measuring range
	$1 \pm 0.2 \text{ cm}^{-1}$	$1 \mu\text{S} - 100 \text{ mS/cm}$



KJB - Stem thermometers



Yellow back

- 1| Brown graduation resistant to physic-chemical agents
- 2| Filled with coloured non contaminant and-non harmful organic liquid
- 3| Glass ring to hang the thermometer, except code KJB017
- 4| Supplied in an individual plastic protection case

Code	Range	Divisions	Length	Batch
KJB003	-10 / 50 °C	0.5 °C	30 cm	10
KJB004	-10 / 110 °C	0.5 °C	30 cm	10
KJB010	-10 / 50 °C	1 °C	30 cm	10
KJB011	-10 / 110 °C	1 °C	30 cm	10
KJB012	-10 / 150 °C	1 °C	30 cm	10
KJB013	-20 / 150 °C	2 °C	30 cm	10
KJB014	-10 / 250 °C	2 °C	30 cm	-
KJB017*	-10 / 50 °C	0.2 °C	55 cm	10
KJB018	-10 / 50 °C	0.1 °C	55 cm	10
KJB019	-10 / 110 °C	0.2 °C	55 cm	10
KJB020	-10 / 110 °C	0.1 °C	55 cm	10
KJB021	-50 / 50 °C	1 °C	30 cm	10
KJB022	-100 / 50 °C	1 °C	30 cm	10
KJB016	Stem thermometers certificate ENAC	-	-	-

* without glass ring



page
[173]

KJD - Enclosed scale



Organic liquid

- 1| Graduated internal scale in black colour
- 2| Filled with coloured non contaminant and-non harmful organic liquid
- 3| Glass ring to hang the thermometer
- 4| Supplied in an individual plastic protection case

Code	Range	Divisions	Length	Batch
KJD001	-10/50 °C	0.5 °C	30 cm	10
KJD002	-10/110 °C	0.5 °C	30 cm	10
KJD005	-10/50 °C	1 °C	30 cm	10
KJD006	-10/110 °C	1 °C	30 cm	10
KJD007	-10/150 °C	1 °C	30 cm	10
KJD008	-10/200 °C	2 °C	30 cm	10
KJD009	-10/250 °C	2 °C	30 cm	-



▶ KJJ - With metallic probe



▶ Digital for ovens



- 1 | LCD display for an easy and fast data reading
- 2 | Temperature measuring in °C or °F
- 3 | Pre-set temperature alarm. Stopwatch up to 20 hours

Code	KJJ001
Functions	Stopwatch, alarm
Range	50/300 °C - 122/572°F
Resolution	1 °C - 1 °F
Probe	60 mm, with 1 m cable
Power supply	1 battery 1.5V (AAA)

▶ Digital



- 1 | Temperature measuring in solids and semisolids (food, soils, etc)
- 2 | LCD display for an easy and fast data reading
- 3 | Penetration probe in stainless steel fixed or with cable

Code	KJJ002
Functions	Clock, stopwatch, alarm
Range	0/200 °C - 32/392 °F
Resolution	1 °C - 1 °F
Probe	170 mm, con cable de 1 m
Power supply	1 battery 1.5V (AAA)

▶ KJM - Environment



▶ Digital



Mod. KJM001

- 1 | Temperature (T) and relative humidity (HR) register
- 2 | With clock function and maximum and minimum register
- 3 | Code KJM001 with outdoors/indoors probe

Code	KJM001	KJM002
T range	-50/70 °C - 58/158 °F	-50/70 °C - 58/158 °F
HT range	5-95 %	10%-99%
Resolution	0.1 °C - 0.1 °F - 1 %HR	0.1 °C - 0.1 °F - 1 %HR
Precision	±1 °C - ±2 °F - ±5 %HR	±1 °C - ±2 °F - ±5 %HR
Probe	3 m	No
Power supply	1 battery 1.5V (AAA)	1 battery 1.5V (AAA)
Batch	25	-

▶ Wood or plastic thermometers



Code	Range	Material	Resolution	Dimensiones
KJM003	-30/50 °C -20/120 °F	Wood	1 °C 2 °F	200x35 mm
KJM006	-40/50 °C -40/120 °F	Plastic	1 °C 2 °F	400x65 mm
KJM015	-15/50 °C 8/120 °F	Plastic	1 2 °F	200x45 mm

KJM - Environment



► For relative humidity (Psychrometers)

- 1 | Made of plastic with protective top for outdoors
- 2 | With double dry-bulb and wet-bulb thermometers
- 3 | Incorporated correlation table to extrapolate readings of relative humidity

Code	Range	Resolution	Dimensiones
KJM014	-10/50 °C	1 °C	300x75 mm



KJP - For refrigerators



► Low temperatures

- 1 | Filled with coloured organic liquid

Code	Description	Range	Divi.	Batch
KJP001	Rod	-40/40 °C	1 °C	10
KJP004	With hook	-40/40 °C	1 °C	50
KJP005	With hook	-40/50 °C	1 °C	10



► Dual digital

- 1 | Register of environment and refrigerator or freezer temperatures
- 2 | Control zone with sound and light alarm
- 3 | Encapsulated probe with suction cap and 1 m cable

Code	KJP002
T range	-50/70 °C -58/158 °F
Resolution	0.1 °C 0.1 °F
Control zone	Freezer (-23/-9.5 °C) - Refrigerator (2/8 °C)
Probe	1 m
Dimensions	135x25x15 mm
Power supply	1 battery 1.5V (AAA)
Batch	25



KJR - Others



► Stem thermometer with ring



- 1 | With ring to hang the thermometer
- 2 | Non-contaminant and non-harmful coloured organic liquid

Code	Range	Resolution
KJR002	0/50 °C	1 °C

▶ KJR - Others

▶ Thermometer for wine



Nahita

- 1 | Wood head that allows holding the thermometer in the bottle neck
- 2 | Non-contaminant and non-harmful coloured organic liquid

Code	Range	Resolution
KJR003	0/40 °C	1 °C

▶ Thermometer for soil



Nahita

- 1 | Inserted in a protective aluminum shell
- 2 | Non-contaminant and non-harmful coloured organic liquid

Code	Range	Resolution
KJR006	-10/110 °C - 20/220 °F	1 °C

▶ KKB - Stopwatches

▶ Digital



Nahita

- 1 | With stopwatch, clock and calendar functions
- 2 | Supplied with cord

Code	KKB001
Clock	12/24 h
Stopwatch	23 h 59 min 59 s
Resolution	1/100 s (≤ 30 min) / 1 s (> 30 min)
Power supply	Lithium battery

▶ Digital for competitions



Nahita

- 1 | Register of elapsed time, split time and first and second place finish times
- 2 | It has clock function and programmable alarm

Code	KKB005
Clock	12/24 h
Calendar	Date and day of the week
Stopwatch	23 h 59 min 59 s
Resolution	1/100 s (≤ 1 h) 1 s (> 1 h)

▶ KKF - Clocks

▶ Mechanical timers

- 1 | Portable and desktop timers
- 2 | With alarm when the selected time is over
- 3 | Resolution: 1 minute

Code	Max. time	Type	Dimensiones
KKF001	60 min	Desktop/wall/magnet	70x70x40 mm



▶ Pocket



- 1 | Ideal for the laboratory thanks to its small size
- 2 | With clamp for coat pocket, magnet for metallic surfaces and ring for vertical position

Code	KKF002
Clock	Mode 12/24 h
Temporizador	Máx. 23 h 59 min 59 s, with 1 min finish alarm
Memory	1
Stopwatch	23 h 59 min 59 s
Dimensiones	52x67x25 mm
Power supply	1 button battery



▶ KLB - Alcohometers



- 1 | Glass body. In Gay Lussac (% alcohol volume) and Cartier scales, calibrated at 20°C
- 2 | Presented in individual case

Code	Range (%V)	Div.	Length	Diameter	Batch
KLB004	0-10 %	1/10	330 mm	31 mm	-
KLB005	10-20 %	1/10	330 mm	31 mm	-
KLB006	20-30 %	1/10	380 mm	31 mm	-
KLB007	30-40 %	1/10	315 mm	30 mm	-
KLB008	40-50 %	1/10	315 mm	30 mm	-
KLB009	50-60 %	1/10	315 mm	28 mm	-
KLB010	60-70 %	1/10	380 mm	25 mm	-
KLB011	70-80 %	1/10	380 mm	25 mm	-
KLB012	80-90 %	1/10	380 mm	22 mm	-
KLB013	90-100 %	1/10	380 mm	23 mm	-
KLB001	0-30 %	1	210 mm	23 mm	10
KLB002	0-50 %	1	260 mm	16 mm	10
KLB003	50-100 %	1	280 mm	16 mm	10
KLB014	0-100 % vol. 10-44 °Cartier	1 1/2	290 mm	15 mm	10



▶ KLD - Baumé hydrometer



- 1 | Glass body. Presented in individual case
- 2 | In Baumé scale (1°Be is equivalent to 25g of sugar dissolved in 1L of water), calibrated at 20°C.

Code	Range (°Be)	Res.	Length	Diameter	Batch
KLD001	0-10	1/10	310 mm	20 mm	12
KLD005	10-20	1/10	310 mm	18 mm	10
KLD007	20-30	1/10	310 mm	18 mm	10
KLD008	30-40	1/10	310 mm	18 mm	10
KLD009	40-50	1/10	310 mm	17 mm	10
KLD010	50-60	1/10	310 mm	16 mm	10
KLD011	60-70	1/10	310 mm	15 mm	10
KLD002	0-30	1	250 mm	13 mm	10
KLD003	0-50	1	240 mm	10 mm	10
KLD004	0-70	1	290 mm	12 mm	10
KLD006	5-15	1/10	310 mm	20 mm	10



▶ KLG - Hydrometers



▶ Hydrometers

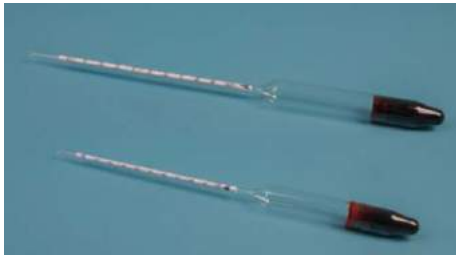

- 1 | Glass body. Presented in individual case
- 2 | In density scale (kg/m^3), calibrated at 20°C

Code	Range (Kg/m^3)	Res.	L (total)x \varnothing	Batch
KLGO01	600-700	1	310x16 mm	12
KLGO02	700-800	1	310x16 mm	10
KLGO03	800-900	1	310x17 mm	12
KLGO04	900-1000	1	310x17 mm	12
KLGO05	1000-1100	1	310x17 mm	12
KLGO06	1100-1200	1	310x17 mm	12
KLGO07	1200-1300	1	310x18 mm	12
KLGO08	1300-1400	1	310x18 mm	12
KLGO09	1400-1500	1	310x18 mm	10
KLGO10	1500-1600	1	310x19 mm	10
KLGO11	1600-1700	1	310x20 mm	10
KLGO12	1700-1800	1	310x20 mm	10

▶ Quevenne lactometer



- 1 | Indicated for determining milk density in the dairy industry
- 2 | Glass body with scale in lacto-densimetric degrees (15° are equivalent to 1015g/mL)
- 3 | Calibrated at 20°C and available option with thermometer for deviation correction
- 4 | Presented in individual case

Code	Range	Res.	L (total)x \varnothing	Thermometer	Batch
KLGO14	15-40	1	215x19 mm	No	10
KLGO15	15-40	1	290x3 mm	Yes (0-40°C)	10

▶ Battery hydrometer



- 1 | It allows checking the electrolyte state of a battery
- 2 | Resistant glass body, with rubber bulb and suction tube
- 3 | Calibrated at 20°C

Code	Range	N° divisions
KLGO20	1100-1300 Kg/m^3	5

▶ KLJ - Saccharometers



- 1 | Indicated for determining the sugar concentration of a solution
- 2 | In Brix scale (1°Brix is equivalent to 1g of saccharose in 100 g of solution (1% in weight))
- 3 | Calibrated at 20°C and available option with thermometer (0-50°C)
- 4 | Presented in individual case
- 5 | All saccharometers have thermometer except code KLJ001

Code	Range (°Bx)	Res.	L (total)x \varnothing	Batch
KLJ001	0-30	1	280x15 mm	-
KLJ002	0-10	1/10	375x25 mm	10
KLJ003	10-20	1/10	375x25 mm	10
KLJ004	20-30	1/10	375x25 mm	10
KLJ005	30-40	1/10	375x25 mm	-
KLJ006	40-50	1/10	375x25 mm	-
KLJ007	50-60	1/10	375x25 mm	-

▶ KLL - Mustimeters



Code	Range	Res.	L (total)xØ	Batch
KLL001	0-30 °Be	1/2	290x17 mm	10
KLL005	0-20 °Be	1/5	260x20 mm	10
	4-22 % alc. probable	1/5		
KLL003	4-18 % alc. probable	1/2	310x19 mm	10
	980-1130 Kg/m ³	1		
Wine hydrometer				
KLL002	-5/30 % vol. alcohol	1/1	245x20 mm	10

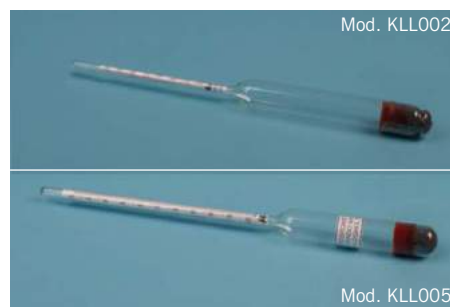

▶ KLN - Liquid hydrometers



1| Glass body. Presented in individual case

Code	For	Range	Res.	L (total)xØ	Batch
KLN003	Syrup	0-50 °Be	1	250x11 mm	8
KLN006	Lye	0-45 °Be	1/2	255x12 mm	8
KLN007	Salt	0-35 °Be	1/2	210x13 mm	10

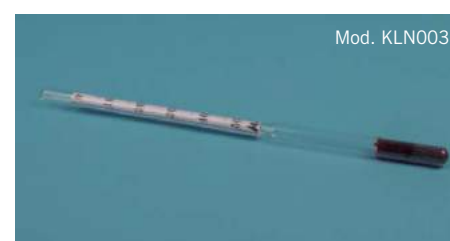

▶ KLQ - Pycnometers

▶ For solids, sand, gravel



Code	Capacity	Tolerance	ØxH (mm)
KLQ004	50 mL	±3 mL	25 x 135



▶ KNB - Rotational viscosimeters



▶ Rotational analogic, model 801

- 1| Analogic rotational viscometer, robust, efficient and of easy use
- 2| Determination of low dynamic viscosities (motor oil, paints, varnishes, etc)
- 3| It has 4 rotation speeds and is equipped with 4 spindles
- 4| Solid column with pinion/rack system to adjust the head height
- 5| Large and stable support base with adjustable legs and bubble level in the head
- 6| Supplied in metallic case

Code	KNB001
Measuring range	10-100000 mPa·s (cp)
Precision	±1%
Spindles	n° 1, 2, 3, 4
Motor speed	6/12/30/60 rpm
Tolerance	± 5% (Newtonian fluids)
Power supply	220V, 50 Hz





KNB - Rotational viscosimeters

▶ Rotational digital, model 802



- 1 | Large and easy use panel board with LCD display and membrane keypad
- 2 | Determination of low dynamic viscosities (motor oil, paints, sauces, etc.)
- 3 | It has 4 rotational speeds and it is equipped with 4 spindles
- 4 | Solid column with pinion/rack system to adjust the head height
- 5 | Large and stable support base with adjustable legs and bubble level in the head
- 6 | It has RS232 port for connection with PC or printer
- 7 | It is supplied in metallic case. It includes temperature probe

Code	KNB002
Measuring range	1-100000 mPa.s (cp)*
Speed	6/12/30/60 rpm
Precision	±1% (Newtonian fluids)
Resolution	0.01 ($\mu \leq 10\text{cp}$) / 0.1 ($10\text{cp} < \mu < 10000\text{cp}$) / 1 ($\mu \geq 10000\text{cp}$)
Repeatability	0.5%
Linearity	±1% (full range)
Spindles	n° 1, 2, 3, 4
Dimensiones	95x130x155 mm (without support)
Power supply	100-240V / 50-60Hz

* for low viscosities the n°0 spindle is needed (not included)

▶ Rotational digital, model 807



- 1 | Large and easy use panel board with LCD display and membrane keypad
- 2 | Determination of medium (syrups, creams, fats...) and high (melted polymers, asphaltic and rubber compounds...) dynamic viscosities
- 3 | Equipped with 4 spindles and temperature probe
- 4 | Solid column with pinion/rack system to adjust the head height
- 5 | Large and stable support base with adjustable legs and bubble level in the head
- 6 | It has RS232 port for connection with PC or printer
- 7 | Supplied in metallic case

Code	KNB003	KNB004
Model	807/1	807/2
Measuring range	1-6x10 ⁵ mPa•s (cP)+	1-6x10 ⁶ mPa•s (cP)*
Speed	1-60 rpm	0.1-99.9 rpm
Precision	±1%	±1%
Resolution	0.01 ($\mu \leq 10\text{cp}$) 0.1 ($10\text{cp} < \mu < 10000\text{cp}$) 1 ($\mu \geq 10000\text{cp}$)	
Repeatability	0.5%	
Linearity	±1% (full range)	
Spindles	n° 1, 2, 3, 4	
Power supply	100-240V / 50-60Hz	

* for low viscosities the n°0 spindle is needed (not included)

▶ KZB - Dissolved oxygen

- 1 | Desktop equipment to measure DO and temperature simultaneously
- 2 | For the control of human consumption waters, urban and industrial sewage waters, industries (fish farms, beverages, canned food) or water circuits in heating systems or boilers among many other applications
- 3 | It includes a polarographic electrode with built-in temperature probe
- 4 | With automatic temperature compensation (ATC) in the range 0-40°C
- 5 | Calibration at 0% and 100% DO saturation, atmospheric pressure and salinity
- 6 | It has a RS-232 port for connection with PC or printer



Code	KZB001
Measuring range	
DO concentration	0.00-19.99 mg/L
DO saturation	0.0-200.0%
Temperature	-5.0/105.0° C
Precision of electric unit	
DO concentration	± 0.10 mg/L
DO saturation	± 1% (full range)
Temperature	± 0.3° C
Precision of meter	
Concentración OD	± 0.30 mg/L (if calibration T-measuring T < ± 3.0° C) ± 0.50 mg/L (if calibration T-measuring T < ± 15.0° C)
DO saturation	± 5% (if calibration T-measuring T < ± 3.0° C) ± 10% (if calibration T-measuring T < ± 15.0° C)
Temperature	± 0.5° C ± 1 digit (between 0.0-60.0° C) ± 1° C ± 1 digit (out of range 0.0-60.0° C)
Stability	± 20 mg/L/1h
Reproducibility	0.20 mg/L
TAC range	0.0-40.0° C (T de solución)
Remaining current	≤ 0.10 mg/L
Answering time	≤ 45 s (90% answer at 20.0° C)
Salinity correction range	0.0-40.0 g/L
Atmospheric pressure correction time	77.0-110.0 kPa
Environmental conditions	5.0-35.0° C; ≤ 80% HR
Memory	50 data groups
Dimensions	290x200x70 mm
Power supply	DC 9 V, 300 mA

▶ Portable dissolved oxygen analyzer 912/8

- 1 | Portable equipment to measure DO and temperature simultaneously in the field
- 2 | For the control of human consumption waters, urban and industrial sewage waters, industries (fish farms, beverages, canned food) or water circuits in heating systems or boilers among many other applications
- 3 | Polycarbonate control panel and large back-lit LCD display
- 4 | It includes a polarographic electrode with built-in temperature probe
- 5 | With automatic temperature compensation (ATC) in the range 0-40°C
- 6 | Calibration at 0% and 100% DO saturation, atmospheric pressure and salinity
- 7 | It has a RS-232 port for connection with PC or printer (TP.16), software included
- 8 | IP65 protection degree



Code	KZB002
Range	
DO concentration	0.00-19.99 mg/L ± 0.50 mg/L
% DO saturation	0.0-199.9 % ± 10.0 %
Temperature	0.0-40.0 °C ± 0.5 °C
Stability	± 0.20 mg/L/1h
Reproducibility	0.20 mg/L
TAC range	0.0-40.0 °C
Memory	100 data groups
Dimensions	210x86x50 mm
Power supply	4 battery (AA)

KZD - Multiparametric

Multiparametric analyzer 917



- 1| Portable equipment to measure multiple parameters simultaneously in water samples
- 2| For the control of human consumption waters, urban and industrial sewage waters, industries (fish farms, beverages, canned food) or water circuits in heating systems or boilers among many other applications
- 3| Polycarbonate control panel and large back-lit LCD display
- 4| Supplied with pH electrodes (combined), conductivity (Pt), DO and T probe
- 5| With automatic temperature compensation (ATC) in all the measuring range
- 6| Calibration function in one, two or multiple points (up to 5 points)
- 7| USB interface for PC connection
- 8| IP65 protection degree

Code	KZD001	
Parameters	Range	Precision
Potential (mV)	-1999.99/+1999.99 mV±	0.03 % (full range)
pH/pX (ion)	-2.000 - 19.999 pH/pX	±0.002 pX ± 1 bit
Conductivity	0.000 μS/cm - 199.9 mS/cm	±0.5 % (FS) ± 1 bit
Resistivity	5.00 Ω·cm - 20 MΩ·cm	
TDS / TDS	0.000 mg/l - 19.99 g/L	±0.5 % (FS) ± 1 bit
Salinity	0.0 - 8.00 %	±0.1 % ± 1 bit
DO concentración	0.00 - 19.99 mg/L	±0.10 mg/L
DO saturación	0.0 - 199.9 %	±1.0 %
Temperature	-5.0 / +135.0 °C	±0.3 °C ± 1 bit
Memory	200 data groups	
Dimensions	210×86×50 mm	
Power supply	9VDC, 800mA, (4 AA batteries included)	

Accessories multiparametric analyzer 917

Code	Description
KZD002	pH electrode f/multiparametric analyzer
KZD003	Conductivity cell f/multiparametric analyzer
KZD004	DO electrode f/multiparametric analyzer



[L] INDEX OF CONTENTS STIRRING

[LB] Magnetic stirrers	185
LBB - With heating, analogical.....	185
LBD - With heating, digital	186
LBG - Without heating, analogical	187
LBJ - Without heating, digital.....	189
LBM - Accessories	189
[LD] Magnets and rods.....	191
LDB - Cylindrical magnets	191
LDD - Oval magnets	191
LDG - Octagonal magnets.....	191
LDP - Other magnets	192
LDR - Stirring rods.....	192
[LG] Vibrating mixers	192
LGB - For tubes.....	192
LGD - For microplates	194
LGG - Accessories.....	194
[LJ] Multidimensional shakers.....	195
LJB - Oscillating.....	195
LJD - Roll and tilt	196
LJG - Rotative	197
LJJ - Rotative, accessories	197
LJL - 3D.....	198
LJN - Orbital	199
LJQ - Linear	200
LJS - Orbital and linear, accessories.....	201
[LL] Overhead stirrers	202
LLB - Stirring heads	202
LLF - Accessories	203

TRADEMARKS:



► MAGNETIC STIRRERS COMPARATIVE CHART: digital and analogic models without heating

	Nahita-BLue 682 LBG002	MINI LBG011	RSLAB 11 NCA LBG010	RSLAB 1F LBG004	RSLAB 1 NC LBG003	RSLAB 11 NCD LBJ001
Model	Analogic	Analogic	Analogic	Analogic	Analogic	Digital
Speed	100/1600 rpm	300-200 rpm	0-1500 rpm	15/1500 rpm	0/1500 rpm	100/1500 rpm
Maximum vol.	5 L	1,5 L	3 L	0,8 L	20 L	3 L
Plate	Metallic with ceramic coating	PET	Plastic	Resistant to chemical agents	Ceramic	Plastic
Plate dim.	190x190 mm	120 mm	135 mm	90 mm	135 mm	135 mm
Dimensions	300x210x126 mm	150x145x50 mm	260x150x80 mm	175x120x15 mm	280x160x85 mm	160x150x80 mm

► MAGNETIC STIRRERS COMPARATIVE CHART: digital and analogic with heating

	RSLAB 1C LBB003	NAHITA 690/1 LBB001	Nahita-blue 692 LBB002	Nahita-blue 692/1 LBD001
Model	Analogic	Analogic	Analogic	Digital
Display	-	-	-	LED
Speed	0/1500 rpm	0/2000 rpm	16000 rpm	1600 rpm
Maximum vol.	20 L	2 L	5 L	5 L
Temp. range	RT 340 °C	RT 180 °C	RT 380 °C	RT 350 °C
Safety temp.	350 °C	-	-	-
Plate	Ceramic	Metallic, EPOXI coated	Metallic, ceramic coated	Metallic, ceramic coated
Plate dim.	135 mm	120x120 mm	190x190 mm	190x190 mm
Dimensions	280x160x85 mm	200x120x90 mm	330x195x125 mm	300x210x126 mm
Probe	Not admitted	Not admitted	Not admitted	PT 1000 ()

	RSLAB 11C LBD005	RSLAB 2C LBD002	RSLAB 3C LBD003	RSLAB 4C LBD004
Model	Digital	Digital	Digital	Digital
Display	LED	LCD	LED	LCD
Speed	100/1500 rpm	100/1500 rpm	0/1500 rpm	100/1500 rpm
Maximum vol.	3 L	20 L	10 L	20 L
Temp. range	RT 280 °C	RT 340 °C	RT 550 °C	RT 550 °C
Safety temp.	320 °C	360 °C	580 °C	580 °C
Plate	Stainless steel	Ceramic	Glass ceramic	Glass ceramic
Plate dim.	135 mm	135 mm	184x184 mm	184x184 mm
Dimensions	260x150x80 mm	260x160x85 mm	360x215x112 mm	360x215x112 mm
Probe	PT 1000 (included)	PT 1000 (included)	PT 1000 (included)	PT 1000 (included)

▶ LBB - Analogic with heating

▶ Analogic with heating Nahita 690/1



- 1| Supplied with rod and clamp and Teflon coated magnet.
Lateral on and off switch

Code	LBB001
Speed range	0-2000 rpm
Maximum stirring volume	2 L
Temperature range	RT-180°C
Plate material	Metallic epoxy coated
Plate size	120x120 mm
Aprox. dimensions	200x120x90 mm
Aprox. weight	2 Kg



▶ With heating Nahita-Blue 692



- 1| Supplied with rod and clamp for holding electrode or thermometer, and stirring magnet
- 2| Speed and heating indicator pilot lights

Code	LBB002
Maximum speed	1600 rpm
Maximum stirring volume	5 L
Temperature range	RT-380°C
Plate material	Metallic with ceramic coating
Plate size	190 x 190 mm
Aprox. dimensions	330 x 195 x 125 mm
Aprox. weight	4,2 Kg



▶ With heating RSLAB-1C



- 1| Analogic speed and time control, constant speed even with load changes.
Brushless motor free of maintenance
- 2| Heating stops automatically when temperature is over 350°C
- 3| It doesn't admit temperature probe

Code	LBB003
Speed range	0-1500 rpm
Maximum stirring volume	20 L
Temperature range	RT-340°C
Plate material	Ceramic
Plate diameter	135 mm
Aprox. dimensions	280 x 160 x 85 mm
Aprox. weight	2,8 Kg



▶ With heating RSLAB-5C, 10 posts



- 1| Internal control of stirring uniformity depending on the number of posts used.
Brushless motor free of maintenance
- 2| Analogic speed and time control, ensures a constant speed while changing sample

Code	LBB004
Speed range	0-1100 rpm
Maximum volume/post	0,4 L
Temperature range	RT-120°C
Safety temperature	140°C
Plate material	Silicone coating
Plate dimensions	182x450 mm
Aprox. dimensions	182x 552x65 mm
Aprox. weight	3,2 Kg





LBD - Digital with heating

▶ With heating 692/1



- 1 | Overheating protection
- 2 | It is supplied with rod and clamp for holding an electrode or thermometer, temperature probe and stirring magnet

Code	LBD001
Display	Back-lit LCD
Maximum speed	1600 rpm
Maximum stirring volume	10 L
Temperature range	RT-350°C
Plate material	Metallic with ceramic coating
Plate size	190 x 190 mm
Aprox. dimensions	300 x 210 x 126 mm
Aprox. weight	4,2 Kg

▶ With heating RSLAB 2C



- 1 | With hermetic protection ring for the body of the equipment
- 2 | It includes temperature probe PT1000, it doesn't include support kit
- 3 | PC control through RS232 interface. Special software StirPC free upon request

Code	LBD002
Display	LCD
Speed range	100-1500 rpm
Maximum stirring volume	20 L
Temperature range	RT-340°C
Safety temperature	360°C
Plate material	Ceramic
Plate diameter	135 mm
Aprox. dimensions	280 x 160 x 85 mm
Aprox. weight	2,8 Kg

▶ With heating RSLAB 3C



- 1 | It includes temperature probe PT1000, it doesn't include the support kit

Code	LBD003
Display	LED
Speed range	0-1500 rpm
Maximum volume	10 L
Temperature range	RT-550°C
Safety temperature	580°C
Plate material	Glass ceramic
Plate dimensions	184x184 mm
Aprox. dimensions	360 x 215 x 112 mm
Aprox. weight	4,5 Kg

▶ LBD - Digital with heating

▶ With heating RSLAB 11C

1 | It includes temperature probe PT1000, it doesn't include the support kit

Code	LBD005
Display	LED
Speed range	100-1500 rpm
Temperature range	RT-280°C
Safety temperature	320°C
Maximum volume	3 L
Plate diameter	135 mm
Plate material	Stainless steel, ceramic coating
Aprox. dimensions	260 x 150 x 80 mm
Aprox. weight	1,8 Kg



▶ With heating RSLAB 4C

- 1 | Supplied with probe Pt1000 that allows a temperature stability of $\pm 0.2^\circ\text{C}$. It doesn't include support kit
- 2 | PC control through RS232 interface with special software StirPc, free upon request

Code	LBD004
Display	LCD
Speed range	100-1500 rpm
Maximum volume	20 L
Temperature range	RT-550°C
Safety temperature	580°C
Plate material	Glass ceramic
Plate dimensions	184x184 mm
Aprox. dimensions	360 x 215 x 112 mm
Aprox. weight	5,3 Kg



▶ LBG - Without heating, analogic

▶ Without heating, 1M-Mini

- 1 | With rod and clamp for electrodes
- 2 | PET stirring surface of excellent chemical resistance

Code	LBG011
Speed range	300 - 2000 rpm
Maximum volume	1,5 L
Plate diameter	120 mm
Plate dimensions	184x184 mm
Aprox. dimensions	150 x 145 x 50 mm
Aprox. weight	0,3 Kg





LBG - Without heating, analogic

▶ Without heating Nahita-Blue 682



- 1 | It is supplied with rod and clamp for holding an electrode or thermometer, and stirring magnet
- 2 | Speed indicator pilot light

Code	LBG002
Speed range	100 - 1600 rpm
Maximum stirring volume	10 L
Plate material	Metallic with ceramic coating
Plate size	190 x 190 mm
Aprox. dimensions	300 x 210 x 126 mm
Aprox. weight	5 Kg

▶ Without heating RSLAB 1NC



- 1 | Motor with electronic speed control, constant speed even with load changes
- 2 | Brushless motor free of maintenance

Code	LBG003
Speed range	0-1500 rpm
Maximum stirring volume	20 L
Plate material	Ceramic
Plate diameter	135 mm
Aprox. dimensions	280 x 160 x 85 mm
Aprox. weight	2,8 Kg

▶ Without heating RSLAB 1F-flat design



- 1 | With auto-reverse system. Thickness of just 15mm

Code	LBG004
Speed range	15-1500 rpm
Maximum stirring volume	0,80 L (H2O)
Max. stirring weight	2 kg
Operation light	Yes
Plate diameter	90 mm
Dimensions (LxWxH)	175 x 120 x 15 mm
Weight	0,30 Kg

▶ Without heating RSLAB 5NC, 10 posts



- 1 | Internal control of stirring uniformity depending on the number of posts used. Brushless motor free of maintenance

Code	LBG005
Speed range	0-1100 rpm
Stirring posts	10
Maximum volume/post	0,4 L
Plate material	Silicone coating
Plate size	182x450 mm
Aprox. dimensions	182x552x65 mm
Aprox. weight	3,2 Kg

▶ LBG - Without heating, analogic

▶ Without heating RSLAB 11NCA

1 | Nylon+GF shell with good resistance to weak acids and bases

Code	LBG010
Speed range	0-1500 rpm
Maximum stirring volume	3 L
Plate material	Nylon+GF
Plate diameter	135 mm
Aprox. dimensions	260 x 150 x 80 mm
Aprox. weight	1,8 Kg



▶ LBJ - Without heating, digital

▶ Without heating RSLAB 11NCD

1 | Nylon+GF shell with good resistance to weak acids and bases

Code	LBJ001
Display	LED
Speed range	100-1500 rpm
Maximum volume	3 L
Plate material	Nylon+GF
Plate diameter	135 mm
Aprox. dimensions	260 x 150 x 80 mm
Aprox. weight	1,8 Kg



▶ LBM - Accessories

▶ CHART 1: Accessories magnetic stirrers 11C, 1C, 2C, 3C, 4C











	Code	Capacity	Model				
			11C	1C	2C	3C	4C
	LBM002	Temperature probe PT1000					
	LBM005	Temp. probe PT1000 with glass coating					
	LBM003	Support kit for probe PT1000					
	LBM004	Support kit for probe PT1000					
	LBM006	Adapter for round bottom flasks 50 mL					
	LBM007	Adapter for round bottom flasks 100 mL					



= Accessory included with the indicated equipment

= Accessory compatible with the indicated equipment



CHART 1: Accessories magnetic stirrers 11C, 1C, 2C, 3C, 4C

	Code	Capacity	Model				
			11C	1C	2C	3C	4C
	LBM008	Adapter for round bottom flasks 250 mL	<input type="checkbox"/>	<input type="checkbox"/>	<input type="checkbox"/>		
	LBM009	Adapter for round bottom flasks 500 mL	<input type="checkbox"/>	<input type="checkbox"/>	<input type="checkbox"/>		
	LBM010	Poly-block red stand with 11 holes for 4 mL tubes	<input type="checkbox"/>	<input type="checkbox"/>	<input type="checkbox"/>	<input type="checkbox"/>	<input type="checkbox"/>
	LBM011	Poly-block purple stand with 4 holes for 20 mL tubes	<input type="checkbox"/>	<input type="checkbox"/>	<input type="checkbox"/>	<input type="checkbox"/>	<input type="checkbox"/>
	LBM012	Poly-block blue stand with 4 holes for 30 mL tubes	<input type="checkbox"/>	<input type="checkbox"/>	<input type="checkbox"/>	<input type="checkbox"/>	<input type="checkbox"/>
	LBM013	Poly-block black stand with 4 holes for 40 mL tubes	<input type="checkbox"/>	<input type="checkbox"/>	<input type="checkbox"/>	<input type="checkbox"/>	<input type="checkbox"/>
	LBM014	Poly-block green stand with 6 holes for 80 mL tubes	<input type="checkbox"/>	<input type="checkbox"/>	<input type="checkbox"/>	<input type="checkbox"/>	<input type="checkbox"/>
	LBM015	Poly block yellow stand with 4 holes with 16 mL tubes	<input type="checkbox"/>	<input type="checkbox"/>	<input type="checkbox"/>	<input type="checkbox"/>	<input type="checkbox"/>
	LBM016	Blue support for 4 poly-block stands	<input type="checkbox"/>	<input type="checkbox"/>	<input type="checkbox"/>		
	LBM017	Blue ring for 4 poly-block stands	<input type="checkbox"/>	<input type="checkbox"/>	<input type="checkbox"/>		
	LBM018	Protective cover resistant up to 135°		<input type="checkbox"/>	<input type="checkbox"/>		

 = Accessory included with the indicated equipment = Accessory compatible with the indicated equipment

▶ LDB - Cylindrical stirring magnets

▶ Economy PTFE coating



1 | Excellent chemical and physical resistance. Resistant up to 275°C

Code	Diameter	Length	Batch
LDB001	4 mm	6 mm	20
LDB002	4 mm	10 mm	20
LDB003	5 mm	15 mm	20
LDB004	7 mm	20 mm	10
LDB005	8 mm	25 mm	10
LDB006	8 mm	30 mm	10
LDB007	8 mm	35 mm	10
LDB008	8 mm	40 mm	10
LDB009	8 mm	45 mm	5
LDB010	8 mm	50 mm	5
LDB011	8 mm	55 mm	5
LDB012	10 mm	60 mm	5
LDB013	8 mm	70 mm	5
LDB014	10 mm	80 mm	5

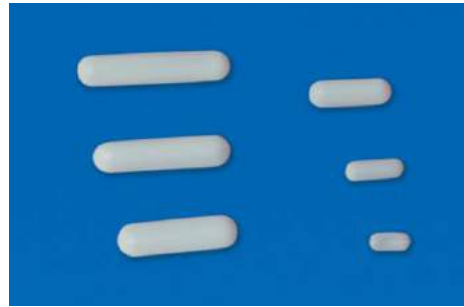

▶ LDD - Oval stirring magnets

▶ PTFE coating



1 | Excellent chemical and physical resistance. Resistant up to 275°C

Code	Length	Diameter
LDD001	10 mm	4 mm
LDD002	15 mm	5 mm
LDD003	20 mm	7 mm
LDD004	25 mm	8 mm
LDD005	30 mm	8 mm
LDD006	35 mm	8 mm
LDD007	40 mm	8 mm
LDD008	45 mm	8 mm
LDD009	50 mm	8 mm

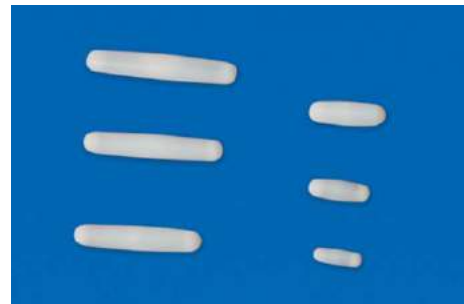

▶ LDG - Octagonal stirring magnets

▶ PTFE coating



1 | Excellent chemical and physical resistance. Resistant up to 275°C

Code	Diameter	Length	Batch
LDG001	6.5 mm	15 mm	10
LDG002	6.5 mm	20 mm	-
LDG003	7.5 mm	25 mm	-
LDG004	7.5 mm	30 mm	-
LDG005	7.5 mm	35 mm	-
LDG006	10 mm	40 mm	10
LDG007	10 mm	45 mm	5





LDP - Other magnets

▶ Stirrer bar retriever



1 | PTFE coating

Code	Length	Magnet (LxØ)	Batch
LDP011	350 mm	43x10 mm	10

▶ Box of various stirring magnets



Code	Description
LDP012	Box of various stirring magnets

Includes:

- **14 cylindrical stirring magnets** 6x4 mm, 10x4 mm, 15x5 mm, 20x7 mm, 25x8 mm, 30x8 mm, 35x8 mm, 40x8 mm, 45x8 mm, 50x8 mm, 55x8 mm, 60x10 mm, 70x10 mm, 80x10 mm
- **1 oval stirring magnet** 50x8 mm
- **3 octagonal stirring magnets** 20x6.5 mm, 30x7.5 mm, 40x10 mm



LDR - Stirring rods

▶ Stirring rod, solid glass



- 1 | Totally inert with burnt ends
- 2 | Suitable for stirring all kind of solutions

Code	Shape	Diameter	Length	Batch
LDR001	Helicoidal	5 mm	200 mm	-
LDR002	Straight	5 mm	200 mm	50
LDR003	Straight	5 mm	300 mm	50
LDR004	Straight	6 mm	400 mm	50
LDR005	Straight	6 mm	500 mm	50



LGB - For tubes

▶ Multiple tube vortex 681/10



1 | For solutions contained in different recipients or various tubes at the same time



Code	LGB001
Speed	2600 RPM
Shaking movement	Vibratory
Shaking amplitude	6,2 mm
Operation type	Continuous at fixed speed
Platform diameter	100 mm
Aprox. dimensions	150 x 130 x 140 mm
Aprox. weight	2,3 Kg

▶ LGB - For tubes

▶ Multi function vortex 681/22











1 | It includes 8 accessories easily interchangeable that allow the use of different recipients

NOTE: accessories included, see below chart



Code	LGB002
Speed	300-3000 rpm
Shaking movement	Orbital
Operation type	Continuous or por contacto
Maximum shaking weight	0,5 Kg
Aprox. dimensions	210 x 150 x 65 mm
Aprox. weight	2.5 Kg

▶ CHART 2: Accessories mixer 681/22 (INCLUDED)

Code	Description
	LGG001 Standard top, for test tubes and small recipients, up to Ø 50 mm
	LGG002 Circular support, for foam accessories
	LGG003 Support for one microplate
	LGG004 Microdisk type adapter
	LGG005 Tube adapter, perforable as needed
	LGG006 Adapter for 14 tubes of 10 mm
	LGG007 Adapter for 6 tubes of 12 mm
	LGG008 Adapter for 4 tubes of 16 mm



LGB - For tubes

Vortex, RSLAB 6PRO

RS Lab

- 1| Adapters fixation system by simple click
- 2| Robust shell, rubber legs and metallic base specially designed for buffering the vibration
- 3| Eccentric wheel with bearings

Code	LGB003
Speed range	0-2500 rpm
Shaking movement	Orbital
Shaking movement	4 mm
Operation mode	Continuous / por contacto
Aprox. dimensions	127 x 130 x 160 mm
Aprox. weight	3,5 Kg



LGD - For microplates

RS Lab

RSLAB 12



- 1| Brushless motor free of maintenance

Code	LGD001
Speed range	0-1500 rpm simple microplate 0-1000 rpm double microplate
Shaking movement	Orbital
Diameter of orbital shaking	4,5 mm
Operation type	Continuous
Maximum shaking weight	0,5 Kg
Aprox. dimensions	260 x 150 x 80 mm
Aprox. weight	3 Kg



LGG - Accessories

RS Lab

CHART 3: Accessories mixers models RSLAB 6PRO and RSLAB 12









	Code	Description	Model	
			RSLAB 12	RSLAB 6PRO
	LGG019	Adapter 1 microplate		
	LGG020	Adapter 2 microplates		
	LGG021	Support for tube adapters continuous mode		
	LGG009	Support for tube adapters continuous mode		

= Accessory included with the indicated equipment

= Accessory compatible with the indicated equipment

▶ LGG - Accesorios

▶ CHART 3: Accessories mixers models RSLAB 6PRO and RSLAB 12

	Code	Capacity	Model	
			RSLAB 12	RSLAB 6PRO
	LGG010	Adapter for 48 PCR microtubes of 6 mm	<input type="checkbox"/>	<input type="checkbox"/>
	LGG011	Adapter for 15 round bottom tubes of 10 mm	<input type="checkbox"/>	<input type="checkbox"/>
	LGG012	Adapter for 12 round bottom tubes of 12 mm	<input type="checkbox"/>	<input type="checkbox"/>
	LGG013	Adapter for 8 round bottom tubes of 16 mm	<input type="checkbox"/>	<input type="checkbox"/>
	LGG014	Adapter for 8 round bottom tubes of 20 mm	<input type="checkbox"/>	<input type="checkbox"/>
	LGG015	Holding rod for tubes with adapters for code LGG010 and LGG014		<input type="checkbox"/>
	LGG016	Standard top for tubes Ø 30 mm		<input type="checkbox" value="i"/>
	LGG018	Anti-slip platform for recipients of 99 mm maximum diameter		<input type="checkbox"/>

▶ LJB - Seesaw

▶ Analogic RSLAB 15

RS Lab

- 1 | Platform with anti-slip coating included
- 2 | It includes 3 small and 3 large elastic bands

Code	LJB002
Speed range	0 – 80 rpm
Shaking movement	Seesaw
Shaking angle	7°
Maximum shaking weight	3 Kg
Operating mode	Continuous
Aprox. dimensions	330 x 270 x 130 mm
Aprox. weight	3,2 Kg





LJB - Seesaw

▶ Digital, RSLAB 15

**RS Lab**

- 1 | Aluminum alloy platform with anti-slip coating, included
- 2 | It includes 8 elastic bands

Code	LJB003
Speed range	10 – 70 rpm
Shaking movement	Seesaw
Shaking angle	9°
Maximum shaking weight	10 Kg
Operation mode	Continuous or programmed
Time range	1-1199 min
Aprox. dimensions	410 x 360 x 200 mm
Aprox. weight	9,0 Kg

▶ Analogic, 683/10

**Nahita**

- 1 | Platform with rubber tray with slots

Code	LJB001
Speed	15 rpm
Shaking movement	Seesaw
Oscillation angle	±25°
Maximum shaking capacity	12 tubes
Platform material	Goma con ranuras
Tamaño platashape	255 x 175 mm
Aprox. dimensions	350 x 200 x 95 mm
Aprox. weight	2,5 Kg



LJD - With rollers

▶ Analogic, 683

**Nahita**

- 1 | It allows shaking diverse types of tubes with different liquid, viscous samples or solids suspensions that require minimum airming

Code	LJD001
Speed range	10-80 rpm
Shaking movement	Rolling
Number of rollers	7
Roller length	240 mm
Aprox. dimensions	400 x 250 x 100 mm
Aprox. weight	4 Kg

▶ Analogic, RSLAB 10

**RS Lab**

- 1 | It allows shaking diverse types of tubes with different liquid, viscous samples or solids suspensions that require minimum airming

Code	LJD002
Speed range	0-70 rpm
Shaking movement	Rolling and seesaw
Number of rollers	6
Operation mode	Continuous
Maximum shaking weight	4 Kg
Aprox. dimensions	450 x 260 x 120mm
Aprox. weight	4,5 Kg

LJG - Rotary

Analogic multiposition, RSLAB 9

- 1 | Rotor capacity: 48 x 1,5ml, 16 x 15ml and 8 x 50ml.
- 2 | Supplied with: 3 bags of 12 adapters of 1.5 ml, 1 bag of 12 adapters of 15 ml and 1 bag of 12 adapters of 50 ml

Code	LJG002	LJG001
Model	9 Disk	9 Rotisserie
Speed range	0 – 80 rpm	
Shaking movement	Rotary	
Operation mode	Continuous	
Aprox. dimensions	300x220x310 mm	50x530x190 mm
Aprox. weight	2,0 Kg	1,7 Kg



REF. LJG002



REF. LJG001

Digital multiposition, RSLAB 9

- 1 | Equipped with braking device
- 2 | Model 9 digital disk is supplied with the disk type accessory for 8 tubes of 50 ml (code LJJ009)
- 3 | Model 9 digital rotisserie is supplied with the vertical rotisserie type accessory for 16 tubes of 50 ml (code LJJ006)

Code	LJG004	LJG003
Model	9 digital disk	9 digital rotisserie
Display	LCD	
Speed range	10-70 rpm	
Shaking movement	Rotary	
Shaking angle	Adjustable from 0° to 90°	
Operation mode	Continuous or programmed	
Timer	1/1199 min	
Aprox. dimensions	510 x 190 x 260 mm	
Aprox. weight	8,0 Kg	
Precio	963,14	1.113,29



REF. LJG004



REF. LJG003

LJJ - Rotary, accessories







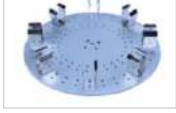



CHART 4: 'Accessories digital rotators RSLAB 9 DIGITAL'



	Code	Capacity	Digital models	
			RSLAB 9 'disk'	RSLAB 9 'rotisserie'
	LJJ001	Horizontal rotisserie type accessory for 48 tubes of 1,5 mL	<input type="checkbox"/>	<input type="checkbox"/>
	LJJ002	Horizontal rotisserie type accessory for 24 tubes of 15 mL	<input type="checkbox"/>	<input type="checkbox"/>
	LJJ003	Horizontal rotisserie type accessory for 24 tubes of 50 mL	<input type="checkbox"/>	<input type="checkbox"/>
	LJJ004	Vertical rotisserie type accessory for 32 tubes of 1,5 mL	<input type="checkbox"/>	<input type="checkbox"/>
	LJJ005	Vertical rotisserie type accessory for 32 tubes of 1,5 mL	<input type="checkbox"/>	<input type="checkbox"/>



LJJ - Rotarys, accesorios

CHART 4: 'Accessories digital rotators RSLAB 9 DIGITAL'

	Code	Capacity	Model	
			RSLAB 9 'disk'	RSLAB 9 'rotisserie'
	LJJ006	Rotisserie type accessory for 16 tubes of 50 ml		
	LJJ007	Disk type accessory for 60 tubes of 1,5 mL		
	LJJ008	Disk type accessory for 16 tubes of 15 mL		
	LJJ009	Disk type accessory for 8 tubes of 50 ml		
	LJJ010	4 support rods to integrate a second disk type support		

 = Accessory included with the indicated equipment = Accessory compatible with the indicated equipment

LJL - 3D

Analogic, RSLAB 14

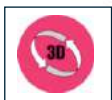
RS Lab

- 1 | Platform with anti-slip coating included
- 2 | It includes 3 small and 3 large elastic bands

Code	LJL001
Movement type	3D orbital
Shaking angle	7°
Speed range	0 – 80 rpm
Operation mode	Continuous
Maximum shaking weight	3 Kg
Platform material	Aluminum alloy, anti-slip coating
Aprox. dimensions	330 x 270 x 130 mm
Aprox. weight	3,2 Kg

Digital, RSLAB 14

RS Lab

- 1 | Supplied with platform with 8 elastic bands

Code	LJL002
Movement type	3D orbital
Shaking angle	9°
Speed range	10 – 70 rpm
Operation mode	Continuous or programmed
Maximum shaking weight	5 Kg
Platform material	Aluminum alloy, anti-slip coating
Aprox. dimensions	430 x 360 x 106 mm
Aprox. weight	9,0 Kg

LJN - Orbitales

▶ Digital, Nahita-blue 685/2



1| Suction pad type legs, it has a timer with a range of 5h 59 min 59s

Code	LJN001
Speed range	30-240 rpm
Shaking movement	Orbital
Shaking amplitude	24 mm
Maximum shaking weight	15 Kg
Platform size	255 x 355 mm
Aprox. dimensions	365 x 255 x 160 mm
Aprox. weight	8,5 Kg



▶ Analogic, RSLAB 7-A



1| Platform with anti-slip coating included
2| It includes 3 small and 3 large elastic bands

Code	LJN002
Speed range	0-200 rpm
Movement type	Orbital
Diameter orbital	20 mm
Operation type	Continuous
Maximum shaking weight	3 Kg
Aprox. dimensions	330 x 270 x 110 mm
Aprox. weight	3,1 Kg
Precio	559.29

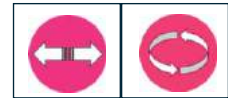

▶ Analogic, RSLAB 7-D



1| Plate with 3 bars included. Brushless motor free of maintenance
2| Over speed detection and protection system
3| PC control through RS232 interface

Code	LJN003
Display	LCD
Speed range	100-800 rpm
Movement type	Orbital
Shaking orbital diameter	4 mm
Operation mode	Continuous or programmed
Maximum shaking weight	2,5 Kg
Timer	1/1199 min
Aprox. dimensions	340 x 300 x 100 mm
Aprox. weight	8,1 Kg

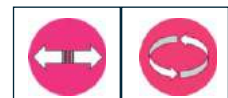

▶ Analogic, RSLAB7-PRO



1| Plate with 4 bars included. Brushless motor free of maintenance
2| Over speed detection and protection system
3| PC control through RS232 interface

Code	LJN004
Display	LCD
Speed range	100-500 rpm
Movement type	Orbital
Shaking orbital diameter	10 mm
Maximum shaking weight	7,5 Kg
Operation mode	Continuous or programmed
Timer	1/1199 min
Aprox. dimensions	420x370x100 mm
Aprox. weight	13,5 Kg





LJQ - Linear

▶ Analogic, RSLAB 7-A

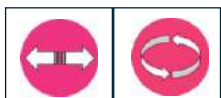
**RS.Lab**

- 1 | Platform with anti-slip coating included
- 2 | It includes 3 small and 3 large elastic bands

Code	LJQ001
Speed range	0-200 rpm
Movement type	Linear
Orbital diameter	20 mm
Operation mode	Continuous
Maximum shaking weight	3 Kg
Aprox. dimensions	330 x 270 x 110 mm
Aprox. weight	3,1 Kg

▶ Digital, RSLAB 7-D

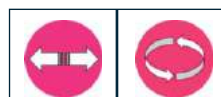
**RS.Lab**

- 1 | Plate with 3 bars included. Brushless motor free of maintenance
- 2 | Over speed detection and protection system
- 3 | PC control through RS232 interface

Code	LJQ002
Display	LCD
Speed range	100-350 rpm
Movement type	Linear
Shaking orbital diameter	4 mm
Operation mode	Continuous or programmed
Maximum shaking weight	2,5 Kg
Timer	1/1199 min
Aprox. dimensions	340 x 300 x 100 mm
Aprox. weight	8,1 Kg

▶ Digital, RSLAB 7-PRO





































































**RS.Lab**

- 1 | Plate with 4 bars included. Brushless motor free of maintenance
- 2 | Over speed detection and protection system
- 3 | PC control through RS232 interface

Code	LJQ003
Display	LCD
Speed range	100-350 rpm
Movement type	Linear
Shaking orbital diameter	10 mm
Maximum shaking weight	7,5 Kg
Operation mode	Continuous or programmed
Timer	1/1199 min
Aprox. dimensions	420x370x100 mm
Aprox. weight	13,5 Kg

 LJS - Orbital-linear, accessories

CHART 5: 'Accessories orbital and linear shakers. Models RSLAB 7, 7 PRO, 14 and 15'

	Code	Capacity	Model							
			7	7 D	14 A	15 A	7 PRO	14 D	15 D	
	LJS006	Universal bar for plate with 3 bars								
	LJS007	Universal bar for plate with 4 bars								
	LJS008	Plate with 3 bars								
	LJS009	Erlenmeyer fixing clip attachment								
	LJS010	Plate with 4 bars								
	LJS013	Anti-slip platform Dimensions: 24x21,5 cm								
	LJS011	Erlenmeyer fixing clip attachment								
	LJS012	Platform with 8 rubbers Dimensions: 30x28,5 cm								
	LJS001	Fixing clip for Erlenmeyer flask 36 units of 25 mL 56 units of 25 mL								
	LJS002	Fixing clip for Erlenmeyer flask 18 units of 50 mL 28 units of 50 mL								
	LJS003	Fixing clip for Erlenmeyer flask 18 units of 100 mL 28 units of 100 mL								
	LJS004	Fixing clip for Erlenmeyer flask 5/8* units of 200/250 mL 13 units of 200/250 mL								
	LJS005	Fixing clip for Erlenmeyer flask 5/8* units of 500 mL 9 units of 500 mL								

Numbers of units corresponds to maximum capacity of each model.

* with 3 fixing points instead of 4

 = Accessory included with the indicated equipment

 = Accessory compatible with the indicated equipment



LLB - Rod stirrers

▶ Analogic, Nahita 686



- 1 | For working with medium/low viscosity liquids
- 2 | Model 686/1 is supplied with: two stirring rods with fixed blade (diameter 30 mm and 100 mm) and ant-slip transparent base (diameter 120 mm)
- 3 | Model 686/2 is supplied with: two stirring rods with fixed blade (diameter 60 mm and 40 mm with 4 holes) and ant-slip transparent base

Code	LLB001	LLB002
Model	686/1	686/2
Speed range	200-1000 rpm	200-2000 rpm
Maximum shaking volume	1 L	2 L
Aprox. dimensions	160x160x370 mm	160x240x500 mm
Aprox. weight	3,5	3,5

▶ Digital, RSLAB 13



- 1 | Sample anti-spill system
- 2 | Stand and stirring rod not included

Code	LLB004	LLB006
Model	13-20	13-40
Display	LED	LED
Speed range	0-2200 rpm	0-2200 rpm
Maximum volume	20 L	40 L
Maximum viscosity	10000 mPas	50000 mPas
Rod dimensions	14x220 mm	14x220 mm
Aprox. dimensions	83x220x186 mm	83x220x186 mm
Aprox. weight	2,6Kg	2,8Kg

▶ Digital, RSLAB 13PRO











- 1 | Sample anti-spill system
- 2 | Overload protection: motor stops automatically in case of continuous overload
- 3 | PC control through RS232 interface
- 4 | It includes stand (code LLF001) and cross stirring rod (code LLF002)

Code	LLB003	LLB005
Model	13PRO-20	13PRO-40
Display	LCD	LCD
Speed range	50-2200 rpm	50-2200 rpm
Maximum volume	20 L	40 L
Maximum viscosity	10000 mPas	50000 mPas
Rod dimensions	14x220 mm	14x220 mm
Aprox. dimensions	83x220x186 mm	83x220x186 mm
Aprox. weight	2,6Kg	2,8Kg

LLF - Accessories



▶ CHART 6: 'Accessories rod stirrers. Models RSLAB 13 and 13PRO'

	Code	Capacity	Model	
			13	13PRO
	LLF002	Stainless steel cross stirring rod, 5x40 cm	<input type="checkbox"/>	<input checked="" type="checkbox"/>
	LLF003	Stainless steel straight stirring rod, 6x40 cm	<input type="checkbox"/>	<input type="checkbox"/>
	LLF004	Stainless steel blade stirring rod, 7x40 cm	<input type="checkbox"/>	<input type="checkbox"/>
	LLF005	Stainless steel centrifuge stirring rod, 9x40 cm	<input type="checkbox"/>	<input type="checkbox"/>
	LLF001	Universal stand	<input type="checkbox"/>	<input checked="" type="checkbox"/>
	LLF006	PTFE cross stirring rod, 5x35 cm	<input type="checkbox"/>	<input type="checkbox"/>
	LLF007	PTFE straight stirring rod, 5x35 cm	<input type="checkbox"/>	<input type="checkbox"/>
	LLF008	PTFE blade stirring rod, 7x35 cm	<input type="checkbox"/>	<input type="checkbox"/>
	LLF009	PTFE centrifuge stirring rod, 9x35 cm	<input type="checkbox"/>	<input type="checkbox"/>

= Accessory included with the indicated equipment

= Accessory compatible with the indicated equipment

LABORATORY
SUPPLIERS

TRADEMARKS

COMPETITIVITY

SERVICES

STOCK

PRODUCT
RANGE

**WE REPRESENT
LEADING BRANDS
IN THE MARKET**

AUXILAB S.L.

Material de laboratorio
Laboratory supplies



ROGO-SAMPAIC
matériel de laboratoire

SOCOREX
SWISS



SIMAX
CZECH REPUBLIC



Kartell



SAINT-GOBAIN
PERFORMANCE PLASTICS



**AUXILAB
+ ROGO
SAMPAIC**

**YOUR BIG LOGISTIC PLATFORM
OF LABORATORY SUPPLIES
AND EQUIPMENT**



[M] INDEX OF CONTENTS LIQUID HANDLING

[MB] Pipette controllers 206
 MBB - Manual controllers.....206
 MBD - Electronic controllers206
 MBG - Controllers, accessories.....206
 MBJ - Pipette pumps207
 MBL - Rubber fillers/teats207
[MD] Bottle-top dispensers 208
 MDD - Adjustable volume.....208
 MDJ - Accessories208
[MG] Micropipettes..... 208
 MGB - Adjustable volume.....208
 MGD - Fixed volume209
 MGG - Multichannel210
 MGJ - Repeater pipettes.....210
 MGM - Electronic pipettes210
 MGT - Stands.....210
[MJ] Tips and other consumables 210
 MJB - 10 µl.....210
 MJJ - 200 µl210
 MJN - 1000 µl210
 MJQ - 2/5/10 ml210
 MJV - Syringes for repeater pipettes211

TRADEMARKS:



▶ MBB - Manual controllers

▶ Manual controllers



DIGIPETTE

- 1 | Ergonomic, lightweight and easy to handle with one hand.
- 2 | Glass and plastic pipettes from 0.1mL up to 100mL.
- 3 | Button for expulsion of the last residual fluid.
- 4 | PTFE hydrophobic filter to protect the internal mechanism.

Referencia	Color
MBB001	White
MBB002	Blue
MBB003	Red
MBB004	Green

▶ MBD - Electronic controllers

▶ Electronic controller



DIGIPETTE

- 1 | Powerful, lightweight and ergonomic instrument.
- 2 | Glass and plastic pipettes from 0.1 mL up to 100 mL.
- 3 | Double protection against fluid penetration by safety valve and PTFE hydrophobic filters (0.2 μ m y 0.45 μ m).
- 4 | Rechargeable batteries for 8 hours of continuous use with low charge indicator.
- 5 | Includes desktop stand and wall mounting stands with screw.



Wall mounting





Desktop stand

Referencia	Description
MBD002	Digipette electronic controller

▶ MBG - Controllers, accessories

▶ CHART 1: 'Digipette electrical controller, accessories'

Code	Description	Model
		Manual y electrónico Digipett
	MBG008 PTFE filter 0.45 μ m Teflon, external diameter: 29 mm	

 = Accessories **incluido** with indicated item

 = Accessories **compatible** with indicated item

▶ MBJ - Pipette pumps

▶ Pipette pumps

DIGIPETTE

- 1| For glass and plastic pipettes.
- 2| One hand easy operation. With colour code.

Code	Capacity	Colour
MBJ007	Up to 2 mL	Blue
MBJ008	Up to 10 mL	Green
MBJ009	Up to 25 mL	Red



▶ MBL - Rubber fillers and teats

▶ Dummy teat

ENDO
plasticware

- 1| Made of latex, for glass Pasteur pipettes.

Code	Description
MBL013	Dummy tea



▶ Rubber teat

ENDO
plasticware

- 1| For glass Pasteur pipettes.

Code	Description	For pipettes
MBL014	Soft rubber	Pasteur, glass
MBL015	Hard rubber	Pasteur, glass
MBL016	Rubber	Up to 5mL
MBL017	Rubber	Up to 10mL
MBL018	Rubber	Up to 15mL



▶ Pipette fillers with 3 valves

ENDO
plasticware

Referencia	Color	Para pipetas
MBL019	Red	Up to 10 mL
MBL020	Green	Up to 100 mL



MDD - Adjustable volume

Bottle dispenser, Dosyproof



DIGIPETTE

- 1 | Soft, comfortable and effective dispensing.
- 2 | Wide chemical compatibility.
- 3 | Autoclavable: these dispenser are resistant to steam sterilization up to 121° C and 2 bar (15 psi) for about 20 minutes.
- 4 | Easy maintenance and cleaning: the disassembly /assembly is simple with a limited number of well-assembled parts.

Code	Volume range	Graduation	Precisión
MDD001	0.5-5.0 mL	0.1 mL	±25 µL
MDD002	1.0-10.0 mL	0.2 mL	±50 µL
MDD003	2.5-25.0 mL	0.5 mL	±125 µL
MDD004	5.0-50.0 mL	1.0 mL	±250 µL

MDJ - Accessories

CHART 3: 'Dosyproof bottle dispenser, accessories



Code	Description	Ø
MDJ052	Thread adapter S 40	45/40 mm
MDJ053	Thread adapter GL38	45/38 mm
MDJ054	Thread adapter GL32	45/32 mm
MDJ055	Thread adapter GL28	32/28 mm
MDJ056	Thread adapter GL25	32/25 mm

Model
Dosyproof



Code	Description
MDJ057	Supply tube



Code	Description
MDJ058	Dispenser tube



 = Accessory **included** with indicated items

= Accessory **compatible** with indicated items

MGB - Adjustable volume

Pipetas 'ECO'

DIGIPETTE

- 1 | Especially useful for educational purpose. Robust and resistant design for intensive use.
- 2 | Wide digits display for easy volume selection. With re-calibration mechanism.



Code	Vol. range (µL)	Test Vol. (µL)	Accuracy (%)	Precision (%)
MGB019	0.2-2	0,2	±1.5	<10
		2	±2.0	≤1
MGB020	1-10	1	±4.0	≤2
		10	±1.2	≤0.7
MGB021	2-20	2	±5.0	≤3
		20	±2.5	≤0.8
MGB022	20-100	20	±3.7	≤1.2
		100	±1.9	≤0.4
MGB023	50-200	50	±2.0	≤1.0
		200	±1.0	≤0.4
MGB024	100-1000	100	±1.5	≤0.6
		1000	±1.0	≤0.3
MGB025	1000-5000	1000	±1.5	≤0.6
		5000	±0.8	≤0.3

▶ MGB - Adjustable volume

▶ Adjustable volume. Autoclavables micropipette

DIGIPETTE

- 1| Ergonomic and light design to reduce effort and avoid fatigue during long working periods.
- 2| Fully autoclavable.
- 3| "Clik-stop" mechanism of volumen selection that ensures accurate dispensing of the liquid.
- 4| Easy identification by color code.
- 5| Calibration report according to ISO8655 included with each pipette.



Code	Vol. range (μL)	Resolution (μL)	Test Vol. (μL)	Inaccuracy (%)	Imprecision (%)
MGB001	0.1-2.5	0.01	0.25	12	6
			2.5	2.5	1.6
MGB002	0.5-10	0.1	1	2.5	1.5
			10	1	0.8
MGB003	2-20	0.1	2	3	2
			20	0.9	0.4
MGB004	5-50	0.5	5	2	2
			50	0.6	0.3
MGB005	10-100	0.5	10	3	1.5
			100	0.8	0.15
MGB006	20-200	1	20	2	0.8
			200	0.6	0.15
MGB007	100-1000	5	100	2	0.7
			1000	0.6	0.2
MGB008	500-5000	50	500	2	0.6
			5000	0.5	0.2
MGB009*	500-10000	100	500	3	0.6
			10000	0.6	0.2

* sin eyector de punta; eyección manual

▶ MGD - Fixed volume

▶ Autoclavables micropipette

DIGIPETTE

- 1| Ergonomic and light design to reduce effort and avoid fatigue during long working periods.
- 2| Fully autoclavable.
- 3| Easy identification by color code.
- 4| Calibration report according to ISO8655 included with each pipette.

Code	Vol.	Test	Innaccuracy (±)	Imprecision (±)
MGD001	10 μl	10 μl	0.8 %	0.8 %
MGD002	20 μl	20 μl	0.6 %	0.5 %
MGD003	25 μl	25 μl	0.5 %	0.3 %
MGD004	50 μl	50 μl	0.5 %	0.3 %
MGD005	100 μl	100 μl	0.5 %	0.3 %
MGD006	200 μl	200 μl	0.4 %	0.2 %
MGD007	500 μl	500 μl	0.3 %	0.2 %
MGD008	1000 μl	1000 μl	0.3 %	0.15 %



▶ MGG - Multichannel

▶ Autoclavable micropipette



DIGIPETTE

- 1 | Widely used in immunology, biochemistry, clinical diagnosis and food analysis.
- 2 | Suitable for handling microtiter plates in dilution processes and washing steps, among others.
- 3 | Multichannel volumetric module can rotate 360° to work in the best working position.
- 4 | Easy identification by color code.

Code	Vol. range μl	Res. μl	Test Vol. μl	Innaccuracy (±) %	Imprecision (±) %
8 channels					
MGG001	0.5-10	0.1	1 10	4 1.5	4 1.5
MGG002	5-50	0.5	5 50	3 1	2 0.7
MGG003	10-100	1	10 100	1.5 1	1.5 0.5
MGG004	20-200	1	20 200	1.5 0.7	0.75 0.25
MGG005	30-300	1	30 300	1.5 0.8	0.75 0.25
12 channels					
MGG006	0.5-10	0.1	1 10	4 1.5	4 1.5
MGG007	5-50	0.5	5 50	3 1	2 0.7
MGG008	10-100	1	10 100	1.5 1	1.5 0.5
MGG009	20-200	1	20 200	1.5 0.7	0.75 0.25
MGG010	30-300	1	30 300	1.5 0.8	0.75 0.25

▶ MGJ - Repeater pipettes

▶ Manual dispenser



DIGIPETTE

- 1 | Ideal for saving time and speeding up long serial pipetting operation.
- 2 | Ergonomic design that allows one-hand handling.
- 3 | Suitable for all types of viscosities with guarantee of precision and accuracy.
- 4 | Safe design to avoid pipette contamination or cross contamination.

Code	Description
MGJ001	Manual dispenser Digipette 10 - 5000 μl

▶ MGM - Electrónicas

▶ Pipeta digital DosyPette



DIGIPETTE

- 1 | Functions of pipetting, mixing, stepper and dilution
- 2 | High accuracy, high performance stepper motor assures precision and repeatability and eliminates manual pipetting errors
- 3 | Self calibration: connecting the pipette to a PC through the USB port the user can calibrate the pipette by using the specific software..
- 4 | Autoclavable low part.
- 5 | Adjustable speeds for aspiration and dispensing

Code	Volume (uL)	Increments (uL)	Vol. test (uL)	Inexactitud (uL) %	Imprecisión SD (uL) CV%
MGM039	0.5-10	0.01	10	± 0.10 ± 1.0	0.05 0.50
			1	± 0.03 ± 3.5	0.03 3.00
MGM040	5-50	0.1	50	± 0.40 ± 0.80	0.15 0.30
			5	± 0.15 ± 3.00	0.12 2.50
MGM041	30-300	1	300	± 1.80 ± 0.60	0.60 0.20
			30	± 0.9 ± 3.00	0.21 0.70
MGM042	100-1000	5	1000	± 6.00 ± 0.60	2.00 0.20
			100	± 3.00 ± 3.00	0.60 0.60

▶ MGT - Stands

▶ Stands

DIGIPETTE

1 | Made of acrylic. Allows up to 6 automatic pipettes.

Code	Description
MGT001	Stand for 6 micropipettes



▶ MJB - 10 μ L

▶ Capacity 0.1 - 10 μ L

DIGIPETTE

1 | Made of polypropylene, fully autoclavables.

Code	Colour	Pack
MJB011	Neutral	1000 us. / bags



▶ MJJ - 200 μ L

▶ Capacity 2 - 200 μ L

DIGIPETTE

1 | Made of polypropylene, fully autoclavables.

Code	Colour	Pack
MJJ016	Yellow	1000 us. / bags



▶ MJN - 1000 μ L

▶ Capacity 1000 μ L

DIGIPETTE

1 | Made of polypropylene, fully autoclavables.

Code	Colour	Pack
MJN015	Blue	500



▶ MJQ - 2 - 5 - 10000 mL

▶ Capacidad 1000 - 5000 mL

DIGIPETTE

1 | Made of polypropylene, fully autoclavables.

Code	Colour	Pack
MJQ009	Blue	300



▶ MJV - Syringes for repeater pipettes

▶ Dispenser tip



1 | Non-sterile unique-use tips made of high quality plastic.

Code	Volume	Range	Accuracy
MJV017	0.5 ml	10-50 μ L	\pm 0.9 %
MJV018	1.25 ml	25-125 μ L	\pm 0.9 %
MJV019	2.5 ml	50-250 μ L	\pm 0.8 %
MJV020	5 ml	100-500 μ L	\pm 0.6 %
MJV021	12.5 ml	250-1250 μ L	\pm 0.4 %



[P] INDEX OF CONTENTS FILTRATION AND SEPARATION

[PB] Glass apparatus/Pieces	214	[PN] Funnels	233
PBB - Glass sets	214	PNB - Short stem, glass	233
PBC - Soxhlet extractors	216	PNC - Short stem, plastic	233
PBD - Soxhlet extractors, thimbles.....	217	PNF - Buchner, porcelain	233
PBF - Glass balls	217	PNG - Buchner, glass	234
PBG - Flasks, distillation	217	PNM - For liquid transfer, plastic	235
PBH - Flasks, Erlenmeyer	218	PNZ - others	235
PBJ - Flasks, evaporation	218	[PQ] Separating funnels	235
PBK - Flasks, flat bottom	219	PQB - Squibb	235
PBL - Flasks, round bottom	219	PQD - Gilson	235
PBM - Flasks, pear-shape	220	PQL - Cylindrical	236
PBN - Condensers	220	[PS] Filter paper	236
PBP - Distillation columns	222	PSB - Standard	236
PBQ - Connectors/Adapters	222	PSC - Qualitative, very slow	237
PBR - Extractor bodies	224	PSD - Qualitative, slow	237
PBV - Tubes	224	PSF - Qualitative, medium	238
PBZ - Others	225	PSG - Qualitative, fast	240
[PD] Water purification	225	PSH - Qualitative, very fast	242
PDB - Demineralizers	225	PSK - Quantitative, slow	243
PDD - Demineralizers, accessories	226	PSL - Quantitative, medium	243
PDG - Distillers	226	PSM - Quantitative, fast	244
PDJ - Distillers, accessories	227	PSN - Quantitative, very fast	245
[PG] Rotary evaporators	227	PSP - Glass fiber	245
PGB - Evaporators	227	PSR - Membrane filters	246
PGG - Accessories	228	PSX - Reams	248
[PJ] Filtration systems	229	PSZ - Others	248
PJB - Filtration units/Manifolds	229	[PV] Syringe filters	250
PJD - Accessories	230	PVB - Cellulose acetate/nitrate	250
PJH - Filtering flasks	231	PVZ - Others	251
[PL] Filtration crucibles	232	[PX] Vacuum pumps	252
PLB - Gooch	232	PXB - Membrane pumps	252
PLG - With poreus plates	232	PXL - Water jet pumps	252
		[PZ] Others	252
		PZB - Chromatography	252

TRADEMARKS:



▶ PBB - Glass sets

▶ Simple-fractional distillation set



The main objective of distillation is to separate a liquid blend whose components have different boiling points, or to separate volatile components from non-volatile ones.

It can be conducted in one single evaporation/condensation process, as it happens in simple distillation, or through successive simple distillations that take place in a fractioning column, as it happens in frac-

tional distillation, with a progressive enrichment of the blend in the more volatile component and that is used when the boiling points of the components differ in less than 25°C.

- 1 | Made in borosilicate glass with 29/32 ground joints
- 2 | Supplied in a case for storage and transportation



Code	Description
PBB001	Simple distillation set, 250 mL
PBB002	Fractional distillation set, 250 mL

Composed of:

Code	Description
PBL015	Round bottom flask 250 mL
PBQ028	75° bent adapter for thermometer
PBN010	Liebig condenser 300 mm
PBQ031	Bent distillation adapter 100 mm
KJB011	Thermometer of -10/110°C
FCM010	Clip (POM) for ground joints 29/32 (3 uds)
PBP002	Vigreux column 320 mm (fractional distillation)

*Mounting stand not included

▶ Garcia Tena set



Routine control of volatile acidity (volatile fatty acids of the acetic series) during the elaboration process of wine, cider, etc, allows determining the fermentation state of grape juice, and given that its content is limited by law, establishing the quality of the final product and foreseeing its conservation requirements.

Among the diverse methods used for its determination, it is the Garcia Tena method, approximate method through which the concentration of acetic acid, secondary product mainly coming from alcoholic fermentation, is determined.

- 1 | Made of borosilicate glass with 14/23 ground joints
- 2 | Supplied with a case for storage and transportation



Code	Description
PBB003	García Tena set

Composed of:

Code	Description
CDB013	Erlenmeyer flask, 50 ml
DNB007	Graduated burette, 10 ml
PBN006	Liebig condenser 120 mm
DJJ005	Volumetric pipette 1 mark, 11 ml
PBZ001	Volumetric cylinder 5.1 ml
PBZ002	Volumetric cylinder 3.2 ml
FFJ002	Alcohol lamp 100 ml
PNB001	Short stem funnel, 40 mm
PBL004	Round bottom flask, 50 ml
PBQ034	Double bent piece, 14/23
FCG008	Clamp with rotary bosshead (2 uds)
FCB006	Retort stand 100x175mm
FCM007	Clip (POM) for ground joints 14/23 (2uds)
FCV006	Closed retort ring with bosshead 80 mm
KJB011	Yellow solid stem thermometer colour spirit -10/110°C

▶ PBB - Glass sets

▶ Microscale standard kit



- 1| Complete ground glass kit for basic laboratory assemblies
- 2| Specially indicated for practical lessons of organic/inorganic chemistry
- 3| Made of borosilicate glass with 14/23 ground joints
- 4| Extension kit available to assemble more complex arrangements
- 5| Supplied with case for storage and transportation

Code	Description
PBB004	Microscale standard kit, ground 14/23

Composed of:

Code	Description
PBN009	Liebig condenser 200 mm
PQL001	Addition funnel 25 mL
PBM001	Pear shaped flask 25 mL
PBM003	Pear shaped flask 3 necks (14/23) 100 mL
PBL001	Round bottom flask 10 mL
PBL004	Round bottom flask 50 mL
BMC013	Glass stopper
BMC016	Glass stopper with groove
PBQ026	Thermometer adapter threaded top
PBQ027	75° bent adapter for thermometer
PBQ029	Connecting adapter with hose
PBQ030	Bent distillation adapter 80 mm
PBV004	Storage tube with hose connection 20 mL
KJB013	Thermometer -10/200°C



▶ Microscale standard kit extension



Code	Description
PBB005	Microscale standard kit extension, ground 14/23

Composed of:

Code	Description
LDR003	Stirring rod 5/6x300 mm
PBN029	Cold finger condenser
PBM002	Pear shaped flask 2 necks (14/23) 50 mL
PBL001	Round bottom flask 10 mL
BMC013	Glass stopper
PBQ026	Thermometer adapter threaded top
PBP001	Vigreux column with jacket 250 mm
PBQ032	Claisen adapter
PBQ033	Receiver adapter for 2 flasks
PBZ003	Willstatter filter 50 mm
PBV003	Drying tube



▶ PBC - Soxhlet extraction systems



Soxhlet extraction system allows a solid-liquid type extraction to obtain active principles or to purify substances based on their solubility in certain solvents. Through a cyclical process of evaporation/condensation of the solvent, normally of organic nature (ether, ethanol, benzene, etc), lipid components (essential oils, fats, etc) are dissolved and extracted from a given sample

- 1| Made of borosilicate glass
- 2| Kit composed of round flask, extractor body and Dimroth condenser
- 3| Cellulose cotton extraction thimbles available (consult pag. 365)

▶ 50 mL



Code	Description
PBC001	Soxhlet extraction system, 50 ml

Composed of:

Code	Description	Ground	Batch
PBN026	Dimroth condenser	29/32	-
PBR001	Extractor body	19/26 y 29/32	-
PBK003	Flat bottom flask, 100 mL	19/26	10

Recommended thimbles

PBD006 Extraction thimbles 30x26x100mm*

* Not included

▶ 125 mL



Code	Description
PBC002	Soxhlet extraction system, 125 ml

Composed of:

Code	Description	Ground	Batch
PBN027	Dimroth condenser	45/40	-
PBR002	Extractor body	29/32 y 45/40	-
PBK008	Flat bottom flask, 250 mL	29/32	10

Recommended thimbles

PBD008 Extraction thimbles 36x33x80 mm*

* Not included

▶ 250 mL



Code	Description
PBC003	Soxhlet extraction system, 250 ml

Composed of:

Code	Description	Ground	Batch
PBN028	Dimroth condenser	55/44	-
PBR004	Extractor body	29/32 y 55/44	-
PBK010	Flat bottom flask, 500 mL	29/32	10

Recommended thimbles

PBD010 Extraction thimbles 36x33x100 mm*-

* Not included

▶ PBD - Soxhlet extraction systems, thimbles

- 1 | Made of high mechanical resistant pure fat-free cellulose cotton
- 2 | For solid-liquid Soxhlet, Kumagawa type extraction and other extraction equipments
- 3 | Application in food industry, analyses of atmospheric contamination, cosmetics, pharmacology, etc.

Code	Int. Ø	Ext. Ø	Height	Box of (uds)
PBD001	14 mm	16 mm	30 mm	25
PBD003	19 mm	22 mm	90 mm	25
PBD002	18 mm	22 mm	60 mm	25
PBD004	22 mm	26 mm	60 mm	25
PBD005	23 mm	27 mm	80 mm	25
PBD006	26 mm	30 mm	100 mm	25
PBD007	29 mm	34 mm	80 mm	25
PBD008	33 mm	36 mm	80 mm	25
PBD009	33 mm	36 mm	94 mm	25
PBD010	33 mm	36 mm	100 mm	25
PBD011	34 mm	37 mm	130 mm	25
PBD012	37 mm	41 mm	123 mm	25
PBD013	38 mm	41 mm	150 mm	25
PBD014	41 mm	47 mm	123 mm	25
PBD015	46 mm	52 mm	165 mm	25
PBD016	54 mm	58 mm	170 mm	25
PBD017	58 mm	62 mm	170 mm	25
PBD018	65 mm	70 mm	240 mm	25
PBD019	75 mm	80 mm	200 mm	25
PBD020	75 mm	80 mm	250 mm	25
PBD021	92 mm	95 mm	250 mm	25



▶ PBF - Glass beads



- 1 | Made of sodocalcic glass

Code	Diameter	Bag of
PBF001	2 mm	1 kg
PBF002	3 mm	1 kg
PBF003	4 mm	1 kg
PBF004	5 mm	1 kg
PBF005	6 mm	1 kg
PBF006	7 mm	1 kg
PBF007	8 mm	1 kg

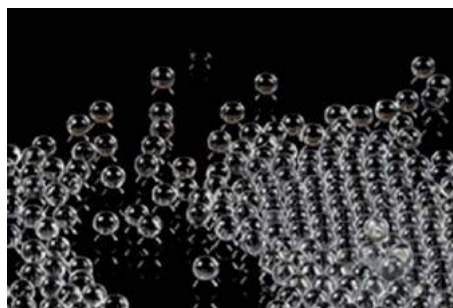

▶ PBG - Flasks, distillation



- 1 | Made of borosilicate glass

Code	Cap.	Neck Ø	Height	Arm Ø	Arm L	Batch
PBG001	100 mL	15 mm	174 mm	7 mm	100 mm	6
PBG002	250 mL	19 mm	216 mm	8 mm	120 mm	12
PBG003	500 mL	24 mm	275 mm	8 mm	150 mm	12
PBG004	1000 mL	28 mm	320 mm	9 mm	180 mm	4



▶ PBH - Flasks, Erlenmeyer

▶ Ground socket

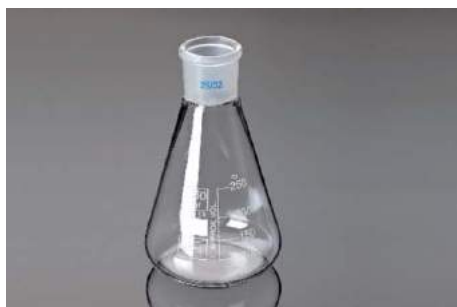

- 1| Ground neck for connection and assemblies
- 2| White graduation
- 3| Made of borosilicate glass
- 4| According to USP/ISO4797 standards except items (*)
- 5| For other volumes or ground joints, consult

Code	Capacity	Ground	Ø (base)	Height	Batch
PBH001*	25 mL	14/23	42 mm	75 mm	10
PBH002*	25 mL	19/26	42 mm	75 mm	10
PBH003	50 mL	14/23	51 mm	85 mm	-
PBH004	50 mL	19/26	51 mm	85 mm	10
PBH005*	50 mL	24/29	64 mm	85 mm	10
PBH006	50 mL	29/32	64 mm	85 mm	10
PBH007*	100 mL	14/23	64 mm	105 mm	10
PBH008	100 mL	19/26	64 mm	105 mm	10
PBH009*	100 mL	24/29	64 mm	105 mm	10
PBH010	100 mL	29/32	64 mm	105 mm	10
PBH011	150 mL	19/26	-	-	10
PBH012	150 mL	29/32	-	-	10
PBH013	250 mL	19/26	85 mm	140 mm	10
PBH014	250 mL	24/29	85 mm	140 mm	10
PBH015	250 mL	29/32	85 mm	140 mm	10
PBH016	500 mL	24/29	105 mm	175 mm	10
PBH017	500 mL	29/32	105 mm	175 mm	10
PBH018*	1000 mL	29/32	131 mm	220 mm	10
PBH019	2000 mL	29/32	166 mm	280 mm	6

▶ Ground cone



- 1| Suitable for filtration assemblies
- 2| Made of borosilicate glass, not graduated

Code	Capacity	Ground (C)
PBH030	1000 mL	40/35

▶ PBJ - Flasks, evaporation

▶ Flasks, evaporation



- 1| Evaporating flask suitable for rotary evaporators
- 2| Made of borosilicate glass and ground neck

Code	Capacity	Ground (S)	Batch
PBJ001	50 mL	29/32	10
PBJ002	100 mL	29/32	10
PBJ003	250 mL	29/32	10
PBJ004	500 mL	29/32	10
PBJ005	1000 mL	29/32	10
PBJ006	2000 mL	29/32	6

▶ PBK - Flasks, flat bottom

▶ Flasks, flat bottom



- 1| Flat bottom round flask with ground neck
- 2| Made of borosilicate glass
- 3| According to USP and ISO/DIN 4797 standards
- 4| For other volumes or ground joints, consult

Code	Capacity	Ground	Height	Ø (base)	Batch
PBK001	50 mL	14/23	85 mm	51 mm	10
PBK002	50 mL	29/32	85 mm	51 mm	10
PBK003	100 mL	19/26	103 mm	64 mm	10
PBK004	100 mL	24/29	103 mm	50 mm	10
PBK005	100 mL	29/32	103 mm	64 mm	10
PBK006	250 mL	19/26	130 mm	85 mm	10
PBK007	250 mL	24/29	130 mm	85 mm	10
PBK008	250 mL	29/32	130 mm	85 mm	10
PBK009	500 mL	24/29	160 mm	103 mm	10
PBK010	500 mL	29/32	160 mm	160 mm	10
PBK011	1000 mL	24/29	187 mm	131 mm	10
PBK012	1000 mL	29/32	187 mm	131 mm	10
PBK013	2000 mL	29/32	230 mm	166 mm	6



▶ PBL - Flasks, round bottom

▶ 1 neck



- 1| Round bottom spherical flask with ground neck
- 2| Made of borosilicate glass
- 3| According to USP and ISO/DIN 4797 standards except items (*)
- 4| For other volumes or ground joints, consult

Code	Capacity	Ground	Height	Ø (base)	Batch
PBL001	10 mL	14/23	35 mm	70 mm	10
PBL002	25 mL	14/23	85 mm	41 mm	10
PBL003*	25 mL	19/26	85 mm	41 mm	10
PBL004	50 mL	14/23	90 mm	51 mm	10
PBL005	50 mL	19/26	90 mm	51 mm	10
PBL006	50 mL	24/29	115 mm	51 mm	10
PBL007	50 mL	29/32	115 mm	51 mm	10
PBL008	100 mL	14/23	105 mm	64 mm	10
PBL009	100 mL	19/26	105 mm	64 mm	10
PBL010	100 mL	24/29	105 mm	64 mm	10
PBL011	100 mL	29/32	105 mm	64 mm	10
PBL012	250 mL	14/23	140 mm	85 mm	10
PBL013	250 mL	19/26	140 mm	85 mm	10
PBL014	250 mL	24/29	140 mm	85 mm	10
PBL015	250 mL	29/32	140 mm	85 mm	10



▶ 1 neck



- 1| Round bottom spherical flask with ground neck
- 2| Made of borosilicate glass
- 3| According to USP and ISO/DIN 4797 standards except items (*)
- 4| For other volumes or ground joints, consult

Code	Capacity	Ground	Height	Ø (base)	Batch
PBL016*	500 mL	19/26	163 mm	105 mm	10
PBL017	500 mL	24/29	163 mm	105 mm	10
PBL018	500 mL	29/32	163 mm	105 mm	10
PBL019	1000 mL	24/29	200 mm	131 mm	10
PBL020	1000 mL	29/32	200 mm	131 mm	10
PBL021	2000 mL	24/29	240 mm	166 mm	10
PBL022	2000 mL	29/32	240 mm	166 mm	10



▶ PBL - Flasks, round bottom

▶ 2-3 necks



- 1| Round bottom spherical flask with ground neck
- 2| Made of borosilicate glass
- 3| According to USP and ISO/DIN 12394
- 4| For other volumes or ground joints, consult

Code	Capacity	Necks	Ground 1	Ground 2	Ground 1	Height
PBL028	250 mL	2	24/29	19/26	--	140 mm
PBL029	500 mL	2	24/29	19/26	--	163 mm
PBL030	1000 mL	3	29/32	29/32	29/32	200 mm

▶ PBM - Flasks, pear-shape



Code	Capacity	Ground (S)	Necks
PBM001	25 mL	14/23	1
PBM002	50 mL	14/23	2
PBM003	100 mL	14/23	3
PBM004	250 mL	29/32	1

▶ PBN - Condensers

▶ Allihn (with balls)



- 1| Balls condenser with double ground neck
- 2| Made of borosilicate glass

Code	L. (useful)	L (total)	Grounds
PBN001	160 mm	280 mm	14/23
PBN002	250 mm	386 mm	29/32

▶ Liebig West



- 1| Condenser with jacket and double ground neck except (*).
- 2| Made of borosilicate glass

Code	L. (useful)	L (total)	Grounds
PBN005	100 mm	220 mm	14/23
PBN006*	120 mm	250 mm	14/23 (H)
PBN007	150 mm	270 mm	14/23
PBN008	200 mm	350 mm	19/26
PBN009	200 mm	310 mm	14/23
PBN010	300 mm	460 mm	29/32
PBN011	300 mm	450 mm	19/26
PBN012	400 mm	560 mm	29/32
PBN013	400 mm	570 mm	19/26

▶ PBN - Condensers

▶ Liebig West without ground joint



Code	L. (useful)	L (total)
PBN014	200 mm	350 mm
PBN015	200 mm	400 mm



▶ Coil condenser



- 1| It has an inner coil through which vapour flows and condenses
- 2| The refrigerating liquid flows through the external jacket
- 3| Made of borosilicate glass

Code	L. (useful)	L (total)	Grounds	
			Socket (S)	Cone (C)
PBN016	120 mm	195 mm	–	–
PBN017	120 mm	205 mm	14/23	–
PBN018	120 mm	215 mm	14/23	14/23
PBN019	160 mm	270 mm	14/23	–
PBN020	200 mm	300 mm	–	45/40
PBN021	250 mm	400 mm	19/26	–
PBN022	350 mm	460 mm	–	–
PBN023	350 mm	470 mm	29/32	–



▶ Dimroth



- 1| It has an inner coil through which the refrigerating liquid flows
- 2| The vapour flows through the coil exterior
- 3| Made of borosilicate glass

Code	L. (useful)	L (total)	Grounds	
			Socket (S)	Cone (C)
PBN025	160 mm	300 mm	14/23	14/23
PBN024	250 mm	400 mm	29/32	29/32

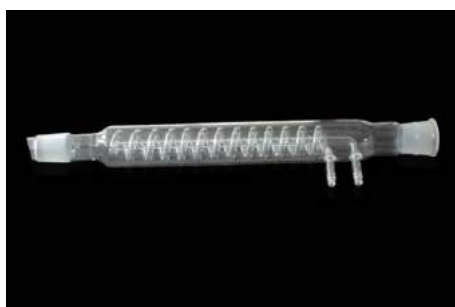

▶ Dimroth for Soxhlet



Code	L. (useful)	L (total)	Ground (M)
PBN026	160 mm	270 mm	29/32
PBN027	180 mm	310 mm	45/40
PBN028	200 mm	360 mm	55/44



PBN - Condensers

Cold finger condenser



- 1 | It allows having a localized cold spot
- 2 | Made of borosilicate glass

Code	Ground (M)	Hose
PBN029	14/23	13 mm

PBP - Distillation columns

Distilling columns (Vigreux)



- 1 | Suitable for the fractional distillation set
- 2 | Made of borosilicate glass

Code	Length	Diameter	Ground	Jacket
PBP001	250 mm	25 mm	14/23	Yes
PBP002	320 mm	32 mm	29/32	No

PBQ - Connectors/Adapters

Double bent piece



Code	Diameter	Length	Ground	Batch
PBQ021	7 mm	160 mm	-	10
PBQ022	12 mm	250 mm	-	5
PBQ034	7 mm	160 mm	14/23 (C/C)	10
PBQ035	25 mm	280 mm	29/32 (C/C)	2

Thermometer adapters, with threaded top



- 1 | With threaded top to fit a control thermometer

Code	Thread	Ground	Angle
PBQ026	13	14/23 (C)	-
PBQ027	8	14/23 (C/C)	75°
PBQ028	18	29/32 (C/C)	75°

▶ PBQ - Connectors/Adapters

▶ Adapter with hose connection



Code	Ground	Hose Ø
PBQ029	14/23 (C/S)	10 mm



▶ Bent distillation adapter



1 | 105° angle

Code	Length	Ground	Ø (tube)
PBQ030	80 mm	14/23	9 mm
PBQ031	100 mm	29/32	13 mm



▶ Claisen thermometer adapters



Code	Thread	Ground	Angle
PBQ032	13	14/23 (S/C/C)	-

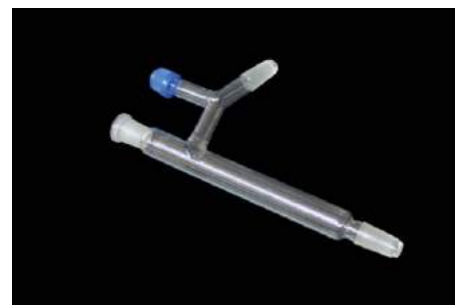

▶ Separating receiver



Code	Ground	Hose Ø
PBQ033	14/23 (C/S)	10 mm



▶ PBR - Extractor bodies

▶ Extractor body



Code	Capacity	Ground (C)	Ground (S)
PBR001	50 mL	19/26	29/32
PBR002	125 mL	29/32	45/40
PBR004	250 mL	29/32	55/44

▶ PBV - Tubes

▶ Digestion tubes



- 1 | Made of borosilicate glass with thick walls and round bottom
- 2 | Diameter 42 mm

Code	Length	Constriction	Digester
PBV001	300 mm	Yes	Buchi
PBV002	300 mm	No	Tecator and others

▶ Storage tube with hose connection



Code	Cap.	Ground	Hose Ø
PBV004	20 mL	14/23	10 mm

▶ Drying tube



Code	Ground
PBV003	14/23

▶ PBZ - Others

▶ Volumetric cylinder



Code	Capacity	Diameter	Height	Batch
PBZ001	5.1 mL	12 mm	110 mm	10
PBZ002	3.2 mL	12 mm	110 mm	10



▶ PBZ - Others

▶ Willstatter filter



1| For the volatile acidity Garcia Tena method

Code	Ground	Diameter
PBZ003	14/23	45 mm



▶ PDB - Demineralizers

▶ Lab-Ion L2 model

- 1| Wall demineralizer to obtain distilled water
- 2| Calcination residue under 1 mg/liter
- 3| Replacement cartridge filled with special resin, bio-degradable and economic
- 4| Supplied complete with wall support

Code	PDB001
Ultra-pure water	0,1-20 μ S/cm
Production (max.)	40 L/h (at 4 bar)
Capacity (máx.)	810 L (at 5°dH)
Resin	Disposable mixed bed
Dimensions	115 x 515 mm
Power supply	110-220V, 50/60 Hz



▶ Micromatic model



- 1| Purifies tap water to Type II Analytical Grade Water for general laboratory use
- 2| Digital interface and microprocessor control for:
 - Continuous monitoring of the produced water
 - Control of the state of the device (in production, full tank, fuse...)
- 3| Quick and easy maintenance without necessity of regular cleaning with acids
- 4| Ecological: significant savings in natural resources such as electricity and water
- 5| The equipment is delivered calibrated from factory (SGC ISO9001)

Code	PDB003	PDB002
Production flow		2,5 L/h
Conductivity		< 1 μ S/cm
Silica removal		>99%
Reverse osmosis efficiency		95/99%
Tank	No	Yes (25 L)
Dimensions		45x25x40 cm
Power		100-240 V, 50-60 Hz
Weight in operation		9 kg



▶ PDD - Demineralizers, accessories

▶ CHART 1: 'Accessories demineralizer LAB-Ion L2'

	Code	Description	Model	
			Lab-Ion L2	Micromatic
	PDD001	Cartridge for demineralizer	<input type="checkbox"/>	
	PDD002	Pretreatment cartridges, Pack of 2 units		<input type="checkbox"/>
	PDD003	Resin cartridges Pack of 4 units		<input type="checkbox"/>
	PDD004	Osmosis cartridge 3 L/h		<input type="checkbox"/>

 = Accessory included with the indicated equipment

= Accessory compatible with the indicated equipment

▶ PDG - Distillers

▶ Glass, model Basic pH4

RS.Lab



- 1 | Continuous distilled water production
- 2 | It has a safety thermostat
- 3 | Robust heating block with chromeplated resistance. Borosilicate glass set

Code	PDG001
Production	4 L/h
Conductivity (running water)	3.0-4.0 μ S/cm
Conductivity (treated water)	1.5-2.0 μ S/cm
pH	5.5-6.0
Resistance	1 x 3000 W
Dimensions	50x15x45 cm
Power supply	220V, 50Hz
Weight	6 kg

page
[226]

▶ Glass, model Quartz

**nahita
blue**



- 1 | Continuous distilled water production. Quartz resistance
- 2 | Safety system with water entry flow sensor
- 3 | Made completely of high quality borosilicate glass
- 4 | With adapted support for wall mounting

Code	PDG002
Production	4 L/h
Conductivity (running water)	2 μ S/cm
Conductivity (treated water)	1,0 L/min
Resistance	1 x 2500 W
Dimensions	55x15x50 cm
Power supply	230V, 50/60Hz, 11A
Weight	4 kg

▶ PDG - Distillers

▶ Model 4000



- 1| Detachable safety frontal display in semitransparent acrylic
- 2| Safety system with water entry flow sensor
- 3| Heating resistances protected with a quartz sheath
- 4| Borosilicate glass set

Code	PDG003
Production	4 L/h
Conductivity (running water)	2 μ S/cm
Conductivity (treated water)	1,4 L/min
Resistance	2 x 2500 W
Dimensions	55x22x40 cm
Power supply	230V, 50/60Hz, 13 A
Weight	12 kg



▶ PDJ - Distillers, accessories

CHART 2: 'Accessories distillers Basic pH 4 and Quartz'

Code	Description	For model
PDJ001	Heating block with resistance	Basic pH 4
PDJ002	Set of joints and connectors	Basic pH 4
PDJ003	Hose set	Basic pH 4
PDJ004	Glass boiler	Basic pH 4
PDJ005	Glass condenser	Basic pH 4
PDJ006	Metal support	Basic pH 4
PDJ007	2 fixing devices f/ boiler	Basic pH 4
PDJ008	Boiler	Quartz
PDJ009	Condenser	Quartz
PDJ010	Level	Quartz
PDJ011	Quartz resistance	Quartz
PDJ012	Flow limiter	Quartz

▶ PGB - Evaporators

▶ 500 and 503 models



- 1| Stainless steel heating bath with LED digital control (Model 500) and analogic control (Model 503) of the temperature
- 2| Elevating motorized system (Model 500) of the glass set
- 3| Analogic adjustment of the rotation speed
- 4| 29/32 ground joints borosilicate glass set (included). 500 mL evaporating flask

Code	PGB001	PGB002
Model	500	503
Bath capacity	3 L	3 L
Rotation speed	10-90 rpm	
Temperature	RT-100 °C	
Inclination angle	45°	
Head adjustment	150 mm Motorized	150 mm Manual
Power supply	220V, 50/60Hz	



REF. PGB001

REF. PGB002

▶ PGB - Evaporators

▶ RS 100-PRO model







RS Lab



- 1 | Large LCD display with continuous digital monitoring
- 2 | Temperature control with adjustable safety circuit
- 3 | Patented condenser (1500 cm² condensing surface)
- 4 | Motorized elevator with quick-action system with adjustable final position recognition
- 5 | Patented pressure spring that results in a perfectly hermetic system
- 6 | Double PTFE coating resistant to chemical agents
- 7 | Borosilicate glass set (included). 1 L evaporating flask
- 8 | USB connection for PC control

Code	PGB006	PGB007
Model	Borosilicate	Borosilicate, coated
Bath capacity	5 L	
	20-280 rpm (reversible rotation)	
Temperature	RT-180 °C (± 1)	
Timer range	1 a 999 min	
Head trajectory	150 mm, motorized	
Power	1400 W	
Dimensions (LxWxH)	465x457x583 mm	
Power supply	220-240V, 50/60Hz	
Protection class (DIN EN60529)	IP20	

▶ PGG - Accessories

▶ CHART 3: 'Accessories rotary evaporators model 500 and 503'







	Code	Capacity	Model	
			500	503
	PGG001	Condenser 29/32	<input type="checkbox"/>	
	PGG002	Distribution head 29/32	<input type="checkbox"/>	
	PGG003	250 mL flask, 29/32	<input type="checkbox"/>	
	PGG004	Inlet pipette with tube and stopcock, 24/29	<input type="checkbox"/>	
	PGG006	Vapour ducting piece, 29/32	<input type="checkbox"/>	<input type="checkbox"/>
	PGG007	500 mL flask, 29/32	<input type="checkbox"/>	<input type="checkbox"/>
	PGG008	Condenser ground joint 29/32		<input type="checkbox"/>

 = Accessory included with the indicated equipment

= Accessory compatible with the indicated equipment

▶ PGG - Accessories

▶ CHART 4: 'Accessories rotary evaporators RSLAB 100-PRO

	Code	Description	Model RS 100-PRO
	PGG014	Complete vertical glassware, 1L	<input type="checkbox"/>
	PGG015	Complete vertical glassware 1L, coated	
	PGG016	Flask adapter, 29-32, 24-29	<input type="checkbox"/>
	PGG017	Flask adapter, 29-32, 19-16	
	PGG018	Flask adapter, 29-32, 14-23	
	PGG019	Foam brake piece, 250 mL (29/32)	<input type="checkbox"/>
	PGG020	Vapour tube piece, ground 29/32	<input type="checkbox"/>
	PGG021	Seal R-type PTFE	<input type="checkbox"/>
	PGG022	Sealing stopper for evaporator	<input type="checkbox"/>
	PGG024	Receiving flask, 100 mL Ground 35-20	<input type="checkbox"/>
	PGG025	Receiving flask, 250 mL Ground 35-20	
	PGG026	Receiving flask, 500 mL Ground 35-20	
	PGG027	Receiving flask, 1000 mL Ground 35-20	
	PGG028	Receiving flask, 2000 mL Ground 35-20	

 = Accessory included with the indicated equipment

= Accessory compatible with the indicated equipment

▶ PJB - Filtration units/Manifolds

▶ Filtration assembly, 300 mL



- 1| Vacuum filtration for analyses of contamination, filtration of solvents for HPLC, etc.
- 2| Borosilicate glass set ground joints 40/32
- 3| Filtration plate (Ø 40 mm) with built-in vacuum connection
- 4| Graduated filtration funnel and anodized aluminum clamp

Code	PJB001	
Composed of:	PJD002	Filtration funnel, 300 mL
	PJD003	Body with fritted glass disk
	PBH030	Erlenmeyer flask (40/35), 1000 mL
	PJD006	Anodized aluminum clamp



PJB - Filtration assemblies/manifolds

Simple circuit vacuum manifolds



- 1| Vacuum filtration for microbiological controls, quality control, analyses of water, solvents, etc.
- 2| Simple circuit vacuum manifolds of 1, 3 and 6 places
- 3| Made of autoclavable stainless steel (316 L)
- 4| They have independent keys or control valves
- 5| Rubber connections included

Code	Places	Valve	Hose	Dimensions
PJB002	1	90°	12 mm	240x120x90 mm
PJB003	3	90°	12 mm	480x120x90 mm
PJB004	6	90°	12 mm	840x120x90 mm

Double circuit vacuum manifolds





- 1| Vacuum filtration for microbiological controls, quality control, analyses of water, solvents, etc.
- 2| Double circuit vacuum manifolds of 3 positions for continuous filtration
- 3| Made of autoclavable stainless steel (316L)
- 4| They have independent keys or control valves. Rubber connections included

Code	Places	Valve	Hose	Dimensions
PJB005	3	90°	12 mm	470x120x90 mm

PJD - Accessories

CHART 5: 'accessories filtration assembly of 300 mL'

	Code	Description	Model Filtration assembly
	PJD002	Filtration funnel of 300 mL	<input type="checkbox"/>
	PJD003	Body with fritted glass disk	<input type="checkbox"/>
	PJD006	Anodized aluminum clamp	<input type="checkbox"/>

= Accessory included with the indicated equipment

= Accessory compatible with the indicated equipment

PJD - Accessories

CHART 6: 'accessories vacuum manifolds'

	Code	Description	Model Vacuum manifolds
	PJD001	Glass filter holder, 300 mL	<input type="checkbox"/>
	Composed of:		
	PJD002	Filtration funnel, 300 mL	
	PJD004	Body with fritted glass disk and silicon stopper	
	PJD005	Silicon stopper 1 hole f/manifold	
	PJD006	Anodized aluminum clamp	
	PJD007	Glass filter holder-manifold connector	
		PJD008	Stainless steel filter holder, 300 mL
PJD009		Stainless steel filter holder, 500 mL	
Composed of:			
PJD011		Stainless steel filtration funnel 300 mL*	
PJD012		Stainless steel filtration funnel 500 mL*	
PJD013		Stainless steel filtration body	
PJD014		Stainless steel grating	
PJD006		Anodized aluminum clamp	
*They include stainless steel stopper (PJD010)			
	PJD010	Stainless steel stopper for filtration funnels	<input type="checkbox"/>
	PJD015	Silicone cap for double manifold	<input type="checkbox"/>

 = Accessory included with the indicated equipment

= Accessory compatible with the indicated equipment

PJH - Filtering flasks

Glass



- 1| Graduated with white marking area
- 2| With lateral hose connection to connect vacuum pumps or water jet pumps
- 3| Borosilicate glass

Code	Cap.	Neck Ø (int.)	Hose Ø	Batch
PJH001	250 mL	30 mm ± 2 mm	12 mm	6
PJH002	500 mL	29 mm ± 2 mm	12 mm	6
PJH003	1000 mL	33 mm ± 2 mm	16 mm	2
PJH004	2000 mL	40 mm ± 2 mm	16 mm	-



▶ PLB - Gooch

▶ Gooch crucible



- 1 | Glazed except rim and base
- 2 | With porous disk and glazed lid with handle

Code	Capacity	Diameter	Height
PLB001	15 mL	32 mm	34 mm
PLB002	20 mL	36 mm	38 mm
PLB003	30 mL	40 mm	46 mm

▶ Gooch crucible

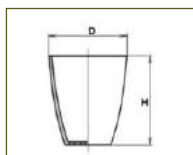

- 1 | With porous disk; without lid
- 2 | Glazed except rim and base

Code	Capacity	Diameter	Height	Batch
PLB004	17 mL	30 mm	36 mm	5
PLB005	25 mL	35 mm	43 mm	5
PLB006	35 mL	39 mm	49 mm	5
PLB007	120 mL	60 mm	71 mm	5

▶ PLG - With porous plate

▶ With porous plate, porcelain



- 1 | Porous bottom; without lid. Glazed except rim and base

Code	Poresity	Volume	Batch
PLG001	6 μm	8 mL	2
PLG004	6 μm	15 mL	2
PLG007	6 μm	25 mL	2
PLG010	6 μm	35 mL	2
PLG013	6 μm	50 mL	2
PLG002	7 μm	8 mL	2
PLG005	7 μm	15 mL	2
PLG008	7 μm	25 mL	2
PLG011	7 μm	35 mL	2
PLG014	7 μm	50 mL	2
PLG003	8 μm	8 mL	2
PLG006	8 μm	15 mL	2
PLG009	8 μm	25 mL	2
PLG012	8 μm	35 mL	2
PLG015	8 μm	50 mL	2

▶ PNB - Short stem, glass

▶ Short stem, glass



- 1 | For transferring liquids or filtering solution
- 2 | 60° cone angle and borosilicate glass (*)

Code	Funnel Ø	Cap.	Stem Ø	Filter Ø	Batch
PNB001	40 mm	10 mL	4 mm	50-60 mm	12
PNB002	50 mm	30 mL	7 mm	50-60 mm	12
PNB003	75 mm	100 mL	9 mm	90-110 mm	10
PNB004	90 mm	150 mL	10 mm	110-125 mm	10
PNB005	100 mm	200 mL	11 mm	110-125 mm	8
PNB006*	120 mm	400 mL	12 mm	125-150 mm	2
PNB007*	150 mm	750 mL	15 mm	150-180 mm	6



▶ PNC - Short stem, plastic

▶ Short stem, plastic



- 1 | Made of autoclavable polypropylene (PP)
- 2 | 60° cone angle and external surface with ribs

Code	Ø (cone)	L x Ø (stem)
PNC001	50 mm	50 x 7 mm
PNC002	75 mm	75 x 9 mm
PNC003	100 mm	95 x 9 mm
PNC004	150 mm	110 x 16 mm

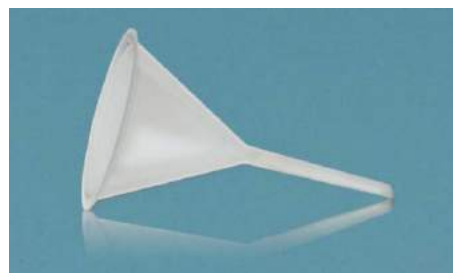

▶ PNF - Büchner, porcelain

▶ Büchner, porcelain



- 1 | Used in vacuum filtration processes
- 2 | With perforated plate to fit filtering paper
- 3 | Glazed

Code	Cap.	Height (total)	int. Ø (total)	middle Ø (total)	Batch
PNF001	30 mL	70 mm	40 mm	13 mm	12
PNF002	50 mL	80 mm	50 mm	15 mm	12
PNF003	120 mL	125 mm	70 mm	20 mm	4
PNF004	200 mL	145 mm	95 mm	21 mm	4
PNF005	400 mL	165 mm	110 mm	26 mm	2
PNF006	600 mL	170 mm	125 mm	30 mm	2
PNF007	1000 mL	195 mm	135 mm	33 mm	--



▶ PNF - Büchner, porcelain

▶ Büchner, porcelain

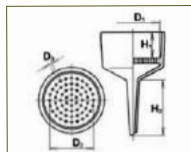

- 1 | Used in vacuum filtration processes
- 2 | With perforated plate to fit filtering paper
- 3 | Glazed

Code	D1 mm	D2 mm	D3 mm	H1 mm	H2 mm	Capacity mL	Filter paper Ø mm
PNF008	48	38	1	24	43	35	45
PNF009	62	45	1	30	64	70	55
PNF010	77	58	1	35	64	120	70
PNF011	97	70	2	40	71	240	90
PNF012	116	95	2	49	83	400	110
PNF013	130	110	2	52	85	600	125
PNF014	156	130	2	59	96	1000	150
PNF015	192	160	2	74	117	2000	185
PNF016	248	220	2	90	117	4000	240
PNF017	296	270	2	105	130	7000	295
PNF018	334	300	2	120	133	10000	325

▶ PNG - Büchner, glass

▶ With sintered disc



- 1 | Glass funnel with sintered disc porosity G0 to G4
- 2 | Borosilicate glass
- 3 | For other volumes and/or porosity, consult

Code	Capacity	Ø (disc)	Porosity
PNG004	35 mL	30 mm	G0
PNG005	35 mL	30 mm	G1
PNG006	35 mL	30 mm	G2
PNG007	35 mL	30 mm	G3
PNG008	35 mL	30 mm	G4
PNG009	80 mL	40 mm	G0
PNG010	80 mL	40 mm	G1
PNG011	80 mL	40 mm	G2
PNG012	80 mL	40 mm	G3
PNG013	80 mL	40 mm	G4
PNG014	200 mL	65 mm	G0
PNG015	200 mL	65 mm	G1
PNG016	200 mL	65 mm	G2
PNG017	200 mL	65 mm	G3
PNG018	200 mL	65 mm	G4
PNG019	500 mL	90 mm	G0
PNG020	500 mL	90 mm	G1
PNG021	500 mL	90 mm	G2
PNG022	500 mL	90 mm	G3
PNG023	500 mL	90 mm	G4
PNG024	1000 mL	120 mm	G0
PNG025	1000 mL	120 mm	G1
PNG026	1000 mL	120 mm	G2
PNG027	1000 mL	120 mm	G3
PNG028	1000 mL	120 mm	G4

▶ PNM - For transferring, plastic

▶ For transferring



- 1 | Autoclavable high density polyethylene (HDPE)
- 2 | With rim and handle and external surface with ribs
- 3 | Suitable product for food contact

Code	Ø (cone)	L x Ø (stem)	Capacity
PNM010	80 mm	13 x 30 mm	100 mL
PNM011	110 mm	15 x 38 mm	300 mL
PNM012	130 mm	20 x 43 mm	450 mL
PNM013	140 mm	24 x 52 mm	750 mL
PNM014	180 mm	30 x 69 mm	1500 mL
PNM015	220 mm	35 x 81 mm	1750 mL
PNM016	260 mm	38 x 75 mm	4000 mL
PNM017	310 mm	43 x 80 mm	5500 mL
PNM018	400 mm	45 x 130 mm	10.000 mL



▶ PNZ - others

▶ Thistle funnel



- 1 | They can be inserted in small holes of stoppers
- 2 | It facilitates the addition of liquids to closed flasks
- 3 | It prevents gas leaks produced in certain reactions

Code	Des.	Length	Funnel Ø	Stem Ø
PNZ002	Straight	300 mm	40 mm	8 mm
PNZ001	With 1 bulb	300 mm	40 mm	8 mm



▶ PQB - Squibb

▶ PTFE stopcock



- 1 | Made of borosilicate glass, ground neck and polypropylene (PP) stopper

Code	Capacity	Ground
PQB001	50 mL	19/29
PQB002	100 mL	19/26
PQB003	125 mL	19/26
PQB005	250 mL	19/26
PQB006	250 mL	24/29
PQB004	250 mL	29/32
PQB008	500 mL	24/29
PQB007	500 mL	29/32
PQB009	1000 mL	29/32
PQB010	2000 mL	29/32



▶ PQD - Gilson

▶ Glass, PTFE stopcock



Code	Capacity	Ground
PQD001	50 mL	19/26
PQD002	100 mL	19/26
PQD003	125 mL	19/26
PQD004	250 mL	19/26
PQD005	250 mL	24/29
PQD006	250 mL	29/32
PQD007	500 mL	24/29
PQD008	1000 mL	29/32



▶ PQL - Cylindrical

▶ PTFE stopcock



Code	Capacity	Ground	Graduation
PQL001	25 mL	14/23	No
PQL002	250 mL	29/32	Yes

▶ PSB - Standard

Filter paper, standard, characteristics

Type	Weight (g/m ²)	Thickness (mm)	pH	Humidity %	Dry resistance (kg)		Wet resistance (kg)		Porosity (μm)		
					Longitudinal	Through	Longitudinal	Through			
Standard	77	0.16/0.18	7	6.8 ± 0.2	3.5/4.0	> 3.5	1.3/1.4	> 2.2	> 0.8	> 0.5	8-11



Code	Ø (mm)	Box of (uds)
Flat		
PSB001	55	100
PSB002	70	100
PSB003	90	100
PSB004	100	100
PSB005	130	100
PSB006	150	100
PSB007	185	100
PSB008	190	100
PSB009	250	100
PSB010	330	100
PSB011	400	100
PSB012	450	100
PSB013	500	100
Folded		
PSB014	70	100
PSB015	100	100
PSB016	130	100
PSB017	150	100
PSB018	190	100
PSB019	250	100
PSB020	330	100
PSB021	400	100
PSB022	450	100
PSB023	500	100
PSB024	650	100

▶ PSC - Qualitative, very slow

▶ Filters FC29E

- 1| Very slow filtering speed
- 2| Extra tough paper
- 3| Ideal for water solutions and volatile liquids such as alcohol, fuel, ether, etc.

FLAT			FOLDED		
Code	Ø (mm)	Pack	Code	Ø (mm)	Pack
PSC001	25	100	PSC022	90	100
PSC002	40	100	PSC023	110	100
PSC003	55	100	PSC024	125	100
PSC004	70	100	PSC025	135	100
PSC005	90	100	PSC026	150	100
PSC006	110	100	PSC027	185	100
PSC007	125	100	PSC028	210	100
PSC008	135	100	PSC029	240	100
PSC009	150	100	PSC030	270	100
PSC010	185	100	PSC031	320	100
PSC011	210	100	PSC032	385	100
PSC012	240	100	PSC033	450	100
PSC013	270	100	PSC034	500	100
PSC014	320	100	PSC035	650	50
PSC015	385	100	PSC036	700	50
PSC016	450	100	PSC037	800	50
PSC017	500	100			
PSC018	650	50			
PSC019	700	50			
PSC020	800	50			
PSC021	900	50			



▶ PSD - Qualitative, slow

▶ Filters FC22L

- 1| Slow filtering speed
- 2| Dense texture of high retention. Ideal for vacuum filtration of injectable serum, etc.

FLAT			FOLDED		
Code	Ø (mm)	Pack	Code	Ø (mm)	Pack
PSD001	25	100	PSD016	70	100
PSD002	40	100	PSD017	90	100
PSD003	55	100	PSD018	110	100
PSD004	70	100	PSD019	125	100
PSD005	90	100	PSD020	135	100
PSD006	110	100	PSD021	150	100
PSD007	125	100	PSD022	185	100
PSD008	135	100	PSD023	210	100
PSD009	150	100	PSD024	240	100
PSD010	185	100	PSD025	270	100
PSD011	210	100	PSD026	320	100
PSD012	240	100	PSD027	385	100
PSD013	270	100	PSD028	450	100
PSD014	320	100	PSD029	500	100
PSD015	385	100			



Characteristics Filters FC22L

Type	Weight (g/m ²)	Thickness (mm)	Retention (µm)	Filtering speed (s)	Wet resistance
FC22L	85	0.20	3	100	Medium

▶ PSD - Qualitative, slow

▶ Filters FC49L



- 1| Slow filtering speed
- 2| 150g/m² paper of high retention and good strength
- 3| Ideal for biochemistry and pharmaceutical industry

FLAT			FOLDED		
Code	Ø (mm)	Pack	Code	Ø (mm)	Pack
PSD032	25	100	PSD047	90	100
PSD033	40	100	PSD048	110	100
PSD034	55	100	PSD049	125	100
PSD030	70	100	PSD050	135	100
PSD031	90	100	PSD051	150	100
PSD035	110	100	PSD052	185	100
PSD036	125	100	PSD053	210	100
PSD037	135	100	PSD054	240	100
PSD038	150	100	PSD055	270	100
PSD039	185	100	PSD056	320	100
PSD040	210	100	PSD057	385	100
PSD041	240	100	PSD058	450	100
PSD042	270	100	PSD059	500	100
PSD043	320	100			
PSD044	385	100			
PSD045	450	100			
PSD046	500	100			

Characteristics Filters FC49L

Type	Weight (g/m ²)	Thickness (mm)	Retention (µm)	Filtering speed (s)	Wet resistance
FC49L	150	0.40	2	180	Very good

▶ PSF - Qualitative, medium



▶ Filters FC28M



- 1| Medium filtering speed
- 2| Very high resistance even wet
- 3| Ideal for acid or alkaline solutions

FLAT			FOLDED		
Code	Ø (mm)	Pack	Code	Ø (mm)	Pack
PSF067	25	100	PSF017	70	100
PSF001	40	100	PSF018	90	100
PSF002	55	100	PSF019	110	100
PSF003	70	100	PSF020	125	100
PSF004	90	100	PSF021	135	100
PSF005	110	100	PSF022	150	100
PSF006	125	100	PSF023	185	100
PSF007	135	100	PSF024	210	100
PSF008	150	100	PSF025	240	100
PSF009	185	100	PSF026	270	100
PSF010	210	100	PSF027	320	100
PSF011	240	100	PSF028	385	100
PSF012	270	100	PSF029	450	100
PSF013	320	100	PSF030	500	100
PSF014	385	100			
PSF015	450	100			
PSF016	500	100			

Characteristics Filters FC28M

Type	Weight (g/m ²)	Thickness (mm)	Retention (µm)	Filtering speed (s)	Wet resistance
FC28M	80	0.18	5	40	Very good

▶ PSF - Qualitative, medium



▶ Filters FC20M

- 1 | Medium filtering speed
- 2 | Good retention capacity
- 3 | Ideal for general applications and for education

FLAT			FOLDED		
Code	Ø (mm)	Pack	Code	Ø (mm)	Pack
PSF031	25	100	PSF048	70	100
PSF032	40	100	PSF049	90	100
PSF033	55	100	PSF050	110	100
PSF034	70	100	PSF051	125	100
PSF035	90	100	PSF052	135	100
PSF036	110	100	PSF053	150	100
PSF037	125	100	PSF054	185	100
PSF038	135	100	PSF055	210	100
PSF039	150	100	PSF056	240	100
PSF040	185	100	PSF057	270	100
PSF041	210	100	PSF058	320	100
PSF042	240	100	PSF059	385	100
PSF043	270	100	PSF060	450	100
PSF044	320	100	PSF061	500	100
PSF045	385	100			
PSF046	450	100			
PSF047	500	100			



Characteristics Filters FC20M

Type	Weight (g/m ²)	Thickness (mm)	Retention (µm)	Filtering speed (s)	Wet resistance
FC20M	77	0.13	5	40	Good

▶ Filters FC75M

- 1 | Medium filtering speed
- 2 | Very pure paper
- 3 | The most used type for qualitative analyses, phosphates, sugars, fertilizers

FLAT			FOLDED		
Code	Ø (mm)	Pack	Code	Ø (mm)	Pack
PSF062	25	100	PSF080	70	100
PSF068	40	100	PSF081	90	100
PSF069	55	100	PSF082	110	100
PSF063	70	100	PSF083	125	100
PSF064	90	100	PSF084	135	100
PSF065	110	100	PSF085	150	100
PSF070	125	100	PSF086	185	100
PSF071	135	100	PSF087	210	100
PSF072	150	100	PSF088	240	100
PSF073	185	100	PSF089	270	100
PSF074	210	100	PSF090	320	100
PSF066	240	100	PSF091	385	100
PSF075	270	100	PSF092	450	100
PSF076	320	100	PSF093	500	100
PSF077	385	100			
PSF078	450	100			
PSF079	500	100			



Characteristics Filters FC75M

Type	Weight (g/m ²)	Thickness (mm)	Retention (µm)	Filtering speed (s)	Wet resistance
FC75M	75	0.16	6	50	Medium

 PSG - Qualitative, fast

 Filters FC27E

- 1 | Fast filtering speed, extra soft thick paper
- 2 | Ideal for the filtration of oils, syrups, fatty substances
- 3 | Also used with Büchner funnels

FLAT			FOLDED		
Code	Ø (mm)	Pack	Code	Ø (mm)	Pack
PSG001	25	100	PSG019	90	100
PSG002	40	100	PSG020	110	100
PSG003	55	100	PSG021	125	100
PSG004	70	100	PSG022	135	100
PSG005	90	100	PSG023	150	100
PSG006	110	100	PSG024	185	100
PSG007	125	100	PSG025	210	100
PSG008	135	100	PSG026	240	100
PSG009	150	100	PSG027	270	100
PSG010	185	100	PSG028	320	100
PSG011	210	100	PSG029	385	100
PSG012	240	100	PSG030	450	100
PSG013	270	100	PSG031	500	100
PSG014	320	100			
PSG015	385	100			
PSG016	450	100			
PSG017	500	100			

Characteristics Filters FC27E

Type	Weight (g/m ²)	Thickness (mm)	Retention (µm)	Filtering speed (s)	Wet resistance
FC27E	160	0.45	8	120	Good

 Filters FC26R

- 1 | Fast filtering speed
- 2 | Very pure paper
- 3 | Ideal for the preparation and analysis of pharmaceutical products and metallurgical analyses.

FLAT			FOLDED		
Code	Ø (mm)	Pack	Code	Ø (mm)	Pack
PSG034	25	100	PSG051	70	100
PSG035	40	100	PSG052	90	100
PSG036	55	100	PSG053	110	100
PSG037	70	100	PSG054	125	100
PSG038	90	100	PSG055	135	100
PSG039	110	100	PSG056	150	100
PSG040	125	100	PSG057	185	100
PSG041	135	100	PSG058	210	100
PSG042	150	100	PSG059	240	100
PSG043	185	100	PSG060	270	100
PSG044	210	100	PSG061	320	100
PSG045	240	100	PSG062	385	100
PSG046	270	100	PSG063	450	100
PSG047	320	100	PSG064	500	100
PSG048	385	100			
PSG049	450	100			
PSG050	500	100			

Characteristics Filters FC26R

Type	Weight (g/m ²)	Thickness (mm)	Retention (µm)	Filtering speed (s)	Wet resistance
FC26R	75	0.15	10	30	Acceptable

▶ PSG - Qualitative, fast

▶ Filters FC21R

- 1| Fast filtering speed
- 2| Very pure paper
- 3| Ideal for filtration of mucilaginous liquids

FLAT			FOLDED		
Code	Ø (mm)	Pack	Code	Ø (mm)	Pack
PSG127	25	100	PSG143	70	100
PSG128	40	100	PSG144	90	100
PSG129	55	100	PSG145	110	100
PSG130	70	100	PSG146	125	100
PSG131	90	100	PSG147	135	100
PSG065	110	100	PSG148	150	100
PSG132	125	100	PSG149	185	100
PSG133	135	100	PSG150	210	100
PSG134	150	100	PSG151	240	100
PSG135	185	100	PSG152	270	100
PSG136	210	100	PSG153	320	100
PSG137	240	100	PSG154	385	100
PSG138	270	100	PSG155	450	100
PSG139	320	100	PSG156	500	100
PSG140	385	100			
PSG141	450	100			
PSG142	500	100			



Characteristics Filters FC21R

Type	Weight (g/m ²)	Thickness (mm)	Retention (µm)	Filtering speed (s)	Wet resistance
FC21R	75	0.17	10	35	Medium

▶ Filters FC150R

- 1| Fast filtering speed
- 2| 150 g/m² crepé paper
- 3| Ideal for filtration of loaded liquids

FLAT				FOLDED		
Code	Ø (mm)	Pack	Precio	Code	Ø (mm)	Pack
PSG066	25	100		PSG080	90	100
PSG067	40	100		PSG081	110	100
PSG068	55	100		PSG082	125	100
PSG069	70	100		PSG083	135	100
PSG070	90	100		PSG084	150	100
PSG071	110	100		PSG085	185	100
PSG072	125	100		PSG086	210	100
PSG073	135	100		PSG087	240	100
PSG074	150	100		PSG088	270	100
PSG075	185	100		PSG089	320	100
PSG076	210	100		PSG090	385	100
PSG077	240	100		PSG091	450	100
PSG078	270	100		PSG092	500	100
PSG079	320	100				
PSG157	385	100				
PSG158	450	100				
PSG159	500	100				



Characteristics Filters FC150R

Type	Weight (g/m ²)	Thickness (mm)	Retention (µm)	Filtering speed (s)	Wet resistance
FC150R	150	0.35	8	40	Very good



PSG - Qualitative, fast

▶ Filters FC25R

- 1| Fast filtering speed
- 2| Plain paper. Ideal for big volume precipitates



FLAT			FOLDED		
Code	Ø (mm)	Pack	Code	Ø (mm)	Pack
PSG093	25	100	PSG110	70	100
PSG094	40	100	PSG111	90	100
PSG095	55	100	PSG112	110	100
PSG096	70	100	PSG113	125	100
PSG097	90	100	PSG114	135	100
PSG098	110	100	PSG115	150	100
PSG099	125	100	PSG116	185	100
PSG100	135	100	PSG117	210	100
PSG101	150	100	PSG118	240	100
PSG102	185	100	PSG119	270	100
PSG103	210	100	PSG120	320	100
PSG104	240	100	PSG121	385	100
PSG105	270	100	PSG122	450	100
PSG106	320	100	PSG123	500	100
PSG107	385	100			
PSG108	450	100			
PSG109	500	100			

Characteristics Filters FC25R

Type	Weight (g/m ²)	Thickness (mm)	Retention (µm)	Filtering speed (s)	Wet resistance
FC25R	77	0.15	8	35	Medium



PSH - Qualitative, very fast

▶ Filters FC75R

- 1| Very fast filtering speed
- 2| Very resistant crepé paper
- 3| Ideal for all kind of very fast filtrations



FLAT			FOLDED		
Code	Ø (mm)	Pack	Code	Ø (mm)	Pack
PSH028	25	100	PSH014	70	100
PSH001	40	100	PSH015	90	100
PSH002	55	100	PSH016	110	100
PSH003	70	100	PSH017	125	100
PSH004	90	100	PSH018	135	100
PSH005	110	100	PSH019	150	100
PSH006	125	100	PSH020	185	100
PSH007	135	100	PSH021	210	100
PSH008	150	100	PSH022	240	100
PSH009	185	100	PSH023	270	100
PSH010	210	100	PSH024	320	100
PSH011	240	100	PSH025	385	100
PSH012	270	100	PSH026	450	100
PSH013	320	100	PSH027	500	100
PSH029	385	100			
PSH030	450	100			
PSH031	500	100			

Characteristics Filters FC75R

Type	Weight (g/m ²)	Thickness (mm)	Retention (µm)	Filtering speed (s)	Wet resistance
FC75R	60	0.12	15	25	Good

▶ PSK - Quantitative, slow

▶ Filters SCLO

- 1| Slow filtering speed, dense texture
- 2| Ideal for retention of fine precipitates

FLAT Code	Ø (mm)	Pack	FOLDED Code	Ø (mm)	Pack
PSK001	12	100	PSK014	70	100
PSK002	22	100	PSK015	90	100
PSK003	40	100	PSK016	110	100
PSK004	55	100	PSK017	125	100
PSK005	70	100	PSK018	135	100
PSK006	90	100	PSK019	150	100
PSK007	110	100	PSK020	185	100
PSK008	125	100	PSK021	210	100
PSK009	135	100	PSK022	240	100
PSK010	150	100			
PSK011	185	100			
PSK012	210	100			
PSK013	240	100			



Characteristics Filters SCLO

Type	Weight (g/m ²)	Thickness (mm)	Retention (µm)	Filtering speed (s)	Wet resistance
SCLO	80	0.2	3	100	Medium

▶ PSL - Quantitative, medium

▶ Filters SCSG

- 1| Medium filtration speed, without fats
- 2| Medium texture
- 3| Ideal for determination of fat content in the food industry

FLAT Code	Ø (mm)	Pack	Precio	FOLDED Code	Ø (mm)	Pack
PSL001	12	100		PSL014	70	100
PSL002	22	100		PSL015	90	100
PSL003	40	100		PSL016	110	100
PSL004	55	100		PSL017	125	100
PSL005	70	100		PSL018	135	100
PSL006	90	100		PSL019	150	100
PSL007	110	100		PSL020	185	100
PSL008	125	100		PSL021	210	100
PSL009	135	100		PSL022	240	100
PSL010	150	100				
PSL011	185	100				
PSL012	210	100				
PSL013	240	100				



Characteristics Filters SCSG

Type	Weight (g/m ²)	Thickness (mm)	Retention (µm)	Filtering speed (s)	Wet resistance
SCSG	80	0.16	6	40	Medium



PSL - Quantitative, medium



▶ Filters SCMO



- 1 | Medium filtration speed, medium texture
- 2 | Ideal for all kind of gravimetric analyses

FLAT			FOLDED		
Code	Ø (mm)	Pack	Code	Ø (mm)	Pack
PSL023	12	100	PSL036	70	100
PSL024	22	100	PSL037	90	100
PSL025	40	100	PSL038	110	100
PSL026	55	100	PSL039	125	100
PSL027	70	100	PSL040	135	100
PSL028	90	100	PSL041	150	100
PSL029	110	100	PSL042	185	100
PSL030	125	100	PSL043	210	100
PSL031	135	100	PSL044	240	100
PSL032	150	100			
PSL033	185	100			
PSL034	210	100			
PSL035	240	100			

Characteristics Filters SCMO

Type	Weight (g/m ²)	Thickness (mm)	Retention (µm)	Filtering speed (s)	Wet resistance
SCMO	80	0.16	6	40	Medium



PSM - Quantitative, fast

▶ Filters SCRO



- 1 | Fast filtering speed
- 2 | Loose texture
- 3 | Ideal for metallurgic laboratories

FLAT			FOLDED		
Code	Ø (mm)	Pack	Code	Ø (mm)	Pack
PSM001	12	100	PSM014	70	100
PSM002	22	100	PSM015	90	100
PSM003	40	100	PSM016	110	100
PSM004	55	100	PSM017	125	100
PSM005	70	100	PSM018	135	100
PSM006	90	100	PSM019	150	100
PSM007	110	100	PSM020	185	100
PSM008	125	100	PSM021	210	100
PSM009	135	100	PSM022	240	100
PSM010	150	100			
PSM011	185	100			
PSM012	210	100			
PSM013	240	100			

Characteristics Filters SCRO

Type	Weight (g/m ²)	Thickness (mm)	Retention (µm)	Filtering speed (s)	Wet resistance
SCRO	80	0.16	10	25	Acceptable

▶ PSN - Quantitative, very fast

▶ Filters SCTR

- 1| Very fast filtering speed
- 2| Loose texture
- 3| Ideal for retention of thick precipitates such as metal hydrides

FLAT			FOLDED		
Code	Ø (mm)	Pack	Code	Ø (mm)	Pack
PSN001	12	100	PSN014	70	100
PSN002	22	100	PSN015	90	100
PSN003	40	100	PSN016	110	100
PSN004	55	100	PSN017	125	100
PSN005	70	100	PSN018	135	100
PSN006	90	100	PSN019	150	100
PSN007	110	100	PSN020	185	100
PSN008	125	100	PSN021	210	100
PSN009	135	100	PSN022	240	100
PSN010	150	100			
PSN011	185	100			
PSN012	210	100			
PSN013	240	100			



Characteristics Filters SCTR

Type	Weight (g/m ²)	Thickness (mm)	Retention (µm)	Filtering speed (s)	Wet resistance
SCTR	80	0.13	15	12	Acceptable

▶ PSP - Glass fiber

▶ Filters FV341

- 1| Ideal for the control of atmospheric contamination

Code	Ø (mm)	Pack
PSP043	20	100
PSP044	21	100
PSP045	24	100
PSP046	25	100
PSP047	40	100
PSP048	45	100
PSP049	47	100
PSP050	55	100
PSP051	60	100
PSP052	70	100
PSP053	90	100
PSP054	110	100
PSP055	125	100
PSP056	130	100
PSP057	140	100
PSP058	150	100
PSP059	160	100
PSP060	185	100
PSP061	200	100
PSP062	210	100
PSP063	240	100



Characteristics Filters FV341

Type	Efficacy (%)	Weight g/m ²	Thickness mm	Retention µM	Filtering speed (S)	Wet resistance (µm)
FV341	95	50	0.30	2	8	Good

▶ PSR - Membrane filters

▶ Gridded sterile



- 1 | Sterilized by gamma radiation
- 2 | Supplied in individual bags

Code	Diameter	Pore	Box of (uds)
PSR001	47 mm	0.45 μm	50
PSR002	47 mm	0.80 μm	50

▶ Gridded membranes



- 1 | They have a printed grid on the surface that allows to make colony counts
- 2 | Non sterile, autoclavables

Code	Diameter	Pore	Box of (uds)
PSR013	13 mm	0.22 μm	100
PSR014	13 mm	0.45 μm	100
PSR015	13 mm	0.80 μm	100
PSR016	25 mm	0.22 μm	100
PSR017	25 mm	0.45 μm	100
PSR018	25 mm	0.80 μm	100
PSR019	47 mm	0.22 μm	25
PSR020	47 mm,	0.45 μm	25
PSR021	47 mm	0.80 μm	25

▶ Membrane filters



Code	Diameter	Pore	Box of (uds)
PSR003	13 mm	0.22 μm	200
PSR004	13 mm	0.45 μm	200
PSR005	13 mm	0.80 μm	200
PSR006	25 mm	0.22 μm	200
PSR007	25 mm	0.45 μm	200
PSR008	25 mm	0.80 μm	200
PSR009	47 mm	0.22 μm	50
PSR010	47 mm	0.45 μm	50
PSR011	47 mm	0.80 μm	50
PSR012	142 mm	0.80 μm	50

▶ Nylon



Code	Diameter	Pore	Box of (uds)
PSR022	25 mm	0,20 μm	100
PSR023	25 mm	0,45 μm	100
PSR024	47 mm	0,20 μm	100
PSR025	47 mm	0,45 μm	100

▶ PSR - Membrane filters

▶ Cellulose acetate

Code	Diameter	Pore	Box of (uds)
PSR026	25 mm	0,20 μm	100
PSR027	25 mm	0,45 μm	100
PSR028	47 mm	0,20 μm	100
PSR029	47 mm	0,45 μm	100



▶ Cellulose nitrate sterile

Code	Diameter	Pore	Type	Units/box
PSR033	47 mm	0,20 μm	White, black grid	100
PSR032	47 mm	0,45 μm	White, black grid	100
PSR030	47 mm	0,20 μm	Black, white grid	100
PSR031	47 mm	0,45 μm	Black, white grid	100



▶ Cellulose nitrate

Code	Diameter	Pore	Box of (uds)
PSR034	25 mm	0,20 μm	100
PSR035	25 mm	0,45 μm	100
PSR036	47 mm	0,20 μm	100
PSR037	47 mm	0,45 μm	100



▶ Polyethersulfone

Code	Diameter	Pore	Box of (uds)
PSR038	25 mm	0,20 μm	100
PSR039	25 mm	0,45 μm	100
PSR040	47 mm	0,20 μm	100
PSR041	47 mm	0,45 μm	100



▶ PTFE

Code	Diameter	Pore	Box of (uds)
PSR042	25 mm	0,20 μm	100
PSR043	25 mm	0,45 μm	100
PSR044	47 mm	0,20 μm	100
PSR045	47 mm	0,45 μm	100



PSR - Membrane filters

Regenerated cellulose



Code	Diameter	Pore	Box of (uds)
PSR046	25 mm	0,20 μm	100
PSR047	25 mm	0,45 μm	100
PSR048	47 mm	0,20 μm	100
PSR049	47 mm	0,45 μm	100

Gridded sterile

Material	Ø 25 mm		Ø 47 mm	
	0.20 μm	0.45 μm	0.20 μm	0.45 μm
Cellulose nitrate	PSR034	PSR035	PSR036	PSR037
Sterile cellulose nitrate			PSR033 (BCN)	PSR032 (BCN)
			PSR030 (NCB)	PSR031 (NCB)
Cellulose acetate	PSR026	PSR027	PSR028	PSR029
Regenerated acetate	PSR046	PSR047	PSR048	PSR049
Nylon	PSR022	PSR023	PSR024	PSR025
Polietersulfona	PSR038	PSR039	PSR040	PSR041
PTFE	PSR042	PSR043	PSR044	PSR045

PSX - Reams

Reams



Code	Paper type	Weight	Dimensions	Ream of
PSX001	Joseph paper	25 g/m ²	15x15 cm	500 sheets
PSX002	Joseph paper	25 g/m ²	35x50 cm	500 sheets
PSX003	Joseph paper	25 g/m ²	35x50 cm	800 sheets
PSX007	White paper 7 Kg	67 g/m ²	40/42x52 cm	500 sheets
PSX005	White paper 7 Kg	77 g/m ²	52x52 cm	500 sheets
PSX004	Grey paper	60 g/m ²	42x52 cm	500 sheets
PSX006	Qualitative paper	77 g/m ²	58x65 cm	100 sheets

PSZ - Otros

Cytoprifugation



1 | Cotton fiber cardboard paper

- 2 | Very thick (420 g/m²), very absorbent
 3 | Used in juice extractions and centrifuges

Code	Dimensions (mm)	Box of
PSZ001	75 x 25	200

▶ PSZ - Others

▶ Antibiotics test

Code	Dimensions (mm)	Box of
PSZ002	6	1000 discos
PSZ003	9	1000 discos
PSZ004	12	1000 discos
PSZ005	13	1000 discos

▶ Nitrogen free

Code	Dimensions (mm)	Box of
PSZ006	120 x 120	200

▶ Phase separation

Code	Dimensions (mm)	Box of
PSZ007	90	100
PSZ008	110	100
PSZ009	125	100
PSZ010	150	100
PSZ011	185	100
PSZ012	210	100
PSZ013	240	100
PSZ014	270	100

▶ Germination test

Code	Dimensions (mm)	Box of
PSZ018	85 x 120	500
PSZ015	100 x 200	500
PSZ016	30 x 200	1000
PSZ017	440 x 680	250
PSZ019	Ø. 85	100

▶ PVB - Cellulose acetate/nitrate

▶ Cellulose acetate



1 | Box of 500 units

Code Ø 13 mm	Pore (µm)	Colour	Code Ø 25 mm	Pore (µm)	Colour
PVB001	0,20	Blue	PVB006	0,20	Blue
PVB002	0,45	Yellow	PVB007	0,45	Yellow
PVB003	0,80	Green	PVB008	0,80	Green
PVB004	1,20	Red	PVB009	1,20	Red
PVB005	5	Brown	PVB010	5	Brown

▶ Cellulose acetate sterile



1 | Box of 500 units

Code Ø 13 mm	Pore (µm)	Colour	Code Ø 25 mm	Pore (µm)	Colour
PVB011	0,20	Blue	PVB016	0,20	Blue
PVB012	0,45	Yellow	PVB017	0,45	Yellow
PVB013	0,80	Green	PVB018	0,80	Green
PVB014	1,20	Red	PVB019	1,20	Red
PVB015	5	Brown	PVB020	5	Brown

▶ Cellulose acetate (PP crankcase)



1 | Box of 500 units

Code Ø 13 mm	Pore (µm)	Code Ø 25 mm	Pore (µm)
PVB021	0,20	PVB026	0,20
PVB022	0,45	PVB027	0,45
PVB023	0,80	PVB028	0,80
PVB024	1,20	PVB029	1,20
PVB025	5	PVB030	5

▶ Regenerated cellulose



1 | Box of 500 units

Code Ø 13 mm	Pore (µm)	Code Ø 25 mm	Pore (µm)
PVB031	0,20	PVB033	0,20
PVB032	0,45	PVB034	0,45

▶ PVZ - Others

▶ Nylon

1 | Box of 500 units

Code Ø 13 mm	Pore (µm)	Code Ø 25 mm	Pore (µm)
PVZ001	0,20	PVZ003	0,20
PVZ002	0,45	PVZ004	0,45



▶ Polyethersulfone

1 | Box of 500 units

Code Ø 13 mm	Pore (µm)	Code Ø 25 mm	Pore (µm)
PVZ005	0,20	PVZ007	0,20
PVZ006	0,45	PVZ008	0,45



▶ PTFE

1 | Box of 500 units.

Code Ø 13 mm	Pore (µm)	Code Ø 25 mm	Pore (µm)
PVZ009	0,20	PVZ011	0,20
PVZ010	0,45	PVZ012	0,45



▶ Glass fiber

Ø 25 mm	Pore (µm)	Box of
PVZ013	0,70	500
PVZ014	1	500
PVZ015	1,2	500
PVZ016	3,10	500



▶ PXB - Membrane pumps

▶ Membrane pumps



- 1 | Oil free, they don't need water, thus, they don't produce any waste water
- 2 | They are provided with an analogic metallic manometer

Code	PXB001	PXB002
Vacuum pressure	638 mm Hg (Torr)/ 0.085 MP / 850 mbar	600 mm Hg (Torr)/ 0.08 MP / 800 mbar
Flow	10 L/min - 0.6 m ³ /h	25 L/min - 1.5 m ³ /h
Consumption	20 W	40 W
Weight	4 Kg	7 Kg
Dimensions	245 x 135 x 245 mm	280 x 140 x 220 mm
Power supply	220-240v 50hz	220-240v 50hz

▶ PXL - Water jet pumps

▶ Water jet pump



- 1 | Minimum water pressure 4 kg/cm²
- 2 | Approximate vacuum of 17 mmHg

Code	Length	Upper Ø	Hose Ø
PXL001	320 mm	18 mm	10 mm

▶ PZB - Chromatography

▶ Chromatography paper



Code	Dimensions (mm)	Box of
PZB006	100 x 300	100 sheets
PZB003	200 x 200	100 sheets
PZB004	250 x 250	100 sheets
PZB005	285 x 250	25 sheets
PZB007	460 x 570	100 sheets
PZB008	580 x 600	100 sheets



[Q] INDEX OF CONTENTS DIDACTIC MATERIAL

[QB] Models 256
 QBB - Anatomy256
 QBG - Botany264
 QBN - Zoology266
 QBQ - Astronomy267
 QBR - Molecular kits.....268

[QG] Prepared slides..... 269
 QGB - Animal histology269
 QGF - Plant histology270
 QGJ - Zoology273
 QGM - Minerals.....275
 QGR - Slide sets.....275

[QL] Physics 279
 QLB - Mechanics and fluids.....279
 QLD - Waves and sound.....280
 QLG - Light and optics282
 QLJ - Thermology284
 QLL - Magnetism and electrostatics286
 QLN - Electricity and electronics.....288

TRADEMARKS:



▶ QBB - Models, anatomy



▶ SENSE ORGANS - Eye



- 1 | Models of eyeball can be dismantled in several parts.
- 2 | These two models show the full structure of the eye: cornea and sclera, iris and choroid, optical nerve and eye muscles.
- 3 | Supplied with base

Code	Parts	Magnifications	Dimensions
QBB001	6	6x	15x15x25 cm

▶ SENSE ORGANS - Ear 3x / 1.5x



- 1 | Representation of the outer, middle and inner ear.
- 2 | Parts: ear flap and canal, eardrum and ossicles, eustachian tube, cochlea, semicircular canals and the auditory nerve.
- 3 | Disassemble parts according to model.
- 4 | Supplied with base.

Code	Parts	Magnifications	Dimensions
QBB002	4	3x	15x36x20 cm
QBB003	3	1.5x	12x17x12 cm

▶ SENSE ORGANS - Nasal cavity



- 1 | The model shows the left upper half of the face.
- 2 | Different structures are represented: frontal, sphenoid and maxillary sinuses, nasal cartilage and septum, olfactory mucosa and bulb, superior, medium and inferior concha.
- 3 | It shows blood supply and nerve endings of the nasal and olfactory mucosa and the palate.
- 4 | Supplied with base.

Code	Parts	Magnifications	Dimensions
QBB004	2	3x	15x28x33 cm

▶ SENSE ORGANS - Skin section



- 1 | Three-dimensional section of human thin skin.
- 2 | Representation of epidermis, dermis and hypodermis.
- 3 | Different structures are also represented such as hair follicles, sebaceous and sweat glands, sensitive receptors, nerves and blood and lymphatic vessels.
- 4 | Supplied with base.

Code	Parts	Magnifications	Dimensions
QBB029	1	60x	17x17x18 cm

QBB - Models, anatomy



► SKELETON AND VERTEBRAL COLUMN - Vertebrae and pelvis

- 1| Shows the morphology and location of the cervical, thoracic, lumbar and sacra.
- 2| The model includes a representation of the intervertebral discs and pelvis.
- 3| Supplied with support.

Code	Parts	Magnifications	Dimensions
QBB006	1	1x	92x34x15 cm



► SKELETON AND VERTEBRAL COLUMN - Flexible vertebral column

- 1| Vertebral column with occipital bone and pelvis.
- 2| Representation of a vertebral arteries and a slipped disc.
- 3| Supplied with steel support.

Code	Parts	Magnifications	Dimensions
QBB007	1	1x	92x34x15 cm



► SKELETON AND VERTEBRAL COLUMN - Mini skeleton

- 1| Table skeleton with base.
- 2| With detachable cranium dome and mandible lower jaw.
- 3| Supplied with support.

Code	Parts	Magnifications	Height
QBB010	1	0.25x	45 cm



► SKELETON AND VERTEBRAL COLUMN - Human skeleton

- 1| Made of PVC, natural size.
- 2| Movable lower jaw with 3 extractable teeth and detachable cranium.
- 3| Nerve branches, vertebral artery and a slipped disc.
- 4| Support with wheels
- 5| Skeleton detailed poster.

Code	Description	Magnifications
QBB011	Human skeleton	1x
QBB012	Numerated human skeleton with muscles	1x



QBB012_Pelvis



QBB012_Rib



QBB012_Knee



**► SKELETON AND VERTEBRAL COLUMN - Cranium and jaw**

- 1 | Life-size representation of the cranium and face skeleton.
- 2 | The cranium dome is detachable.
- 3 | Mobile lower jaw presents 3 extractable teeth.

Code	Parts	Magnifications	Dimensions
QBB014	2	1x	22x15x17 cm

► SKELETON AND VERTEBRAL COLUMN - Body with muscles

- 1 | Made of PVC
- 2 | It includes the representation of more than 400 structures of muscles and internal organs of human body and an explicative index.
- 3 | Internal organs are detachable in a total number of 31 pieces.
- 4 | Placed vertically on a base support with high stability.

Code	Parts	Magnifications	Dimensions
QBB013	32	0.75x	80x33x23 cm

QBB013_Thigh



QBB013_Back



QBB013_Head and neck

**► HEAD AND TORSO - Dual-sex human torso, open back**

- 1 | Made of PVC, life-size.
- 2 | It shows all human systems: digestive, respiratory, urinary, reproductive and nervous.
- 3 | It shows the organs composing the head, neck, thoracic cavity (trachea, lungs, heart, oesophagus), male and female pelvic cavity, abdominal cavity (liver, stomach, intestine, pancreas).
- 4 | It also presents the back opened to show the vertebral column.
- 5 | Assembled on a base.

Code	Parts	Magnifications
QBB041	24	1x

▶ QBB - Models, anatomy

▶ HEAD AND TORSO - Human mini torso with head

- 1| Human male mini-torso.
- 2| With the following detachable pieces: head, brain, lung lobules, stomach, heart, liver, intestinal pack and male genital system.
- 3| Supplied with base.

Code	Parts	Height
QBB015	12	42 cm



▶ HEAD AND TORSO - Head and neck

- 1| Natural size.
- 2| Left hemisphere can be disassembled into four parts: head, left side of cranium, eyeball and cerebellum.
- 3| Supplied with base.

Code	Parts	Magnifications
QBB026	7	1x



▶ NERVOUS SYSTEM - Spinal cord

- 1| Made of PVC.
- 2| Representing grey matter (anterior and posterior horns, grey commissure and central canal), white matter (anterior, lateral and posterior funiculus, anterior commissure, anterior median fissure and posterior median sulcus) as well as anterior and posterior roots.
- 3| It includes two vertebrae and shows the motor and sensory roots
- 4| Supplied with base.

Code	Parts	Magnifications
QBB024	1	2x



▶ NERVOUS SYSTEM - Spinal cord, muscle and skin

- 1| Made of PVC.
- 2| It includes the spinal cord (grey and white matter), a skin section with its receptor nerve end and the corresponding muscle with its motor nerve end
- 3| All parts are assembled on the same base.

Code	Parts	Dimensions
QBB025	1	50x36x6 cm

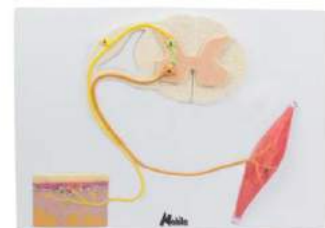

▶ NERVOUS SYSTEM - Brain

- 1| Made of PVC.
- 2| Divided in two part.
- 3| Model QBB027 can be disassembled into frontal and parietal lobes, half the brainstem and half cerebellum.
- 4| Supplied with base.

Code	Parts	Magnifications
QBB027	9	1x
QBB028	2	1x

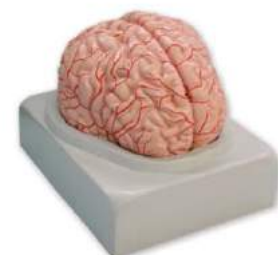



QBB - Models, anatomy



URINARY SYSTEM - Kidney, glomerulus and nephron



- 1 | Kidney longitudinal section, nephron, blood vessels and renal corpuscle representation.
- 2 | All parts are assembled on the same base.

Code	Parts	Magnifications
QBB030	1	3x/100x/650x

URINARY SYSTEM - Renal corpuscle



- 1 | This part of the nephron is responsible for filtration of the plasma.
- 2 | It includes the two basic structures: Bowman capsule and renal glomerulus.
- 3 | All parts are assembled on the same base.

Code	Parts	Magnifications
QBB017	1	700x

URINARY SYSTEM - Urinary system



- 1 | Includes male and female anatomies (longitudinal section) and the organs kidney, ureters, bladder, urethra and blood vessels.
- 2 | Wide and strong panel with a handle to facilitate its use transport.
- 3 | Assembled on a base

Code	Parts	Magnifications
QBB018	1	1x

URINARY SYSTEM - Urinary system



- 1 | Natural size model of the male and female urinary system .
- 2 | 5 detachable pieces corresponding to kidney and genital organs (bladder with prostate and bladder with uterus and ovaries respectively). .
- 3 | The model shows the retroperitoneal cavity, pelvis with bones and muscles, inferior cava, aorta with ramifications, upper urinary tract, kidney with adrenal gland, ureter, bladder, etc..

Code	Parts	Magnifications
QBB019	6	1x

▶ QBB - Models, anatomy

▶ RESPIRATORY SYSTEM - Respiratory system

- 1| They are represented the larynx, lungs and trachea.
- 2| We can see the trachea and two channels in which divides, called bronchial tubes, those bronchial tubes are subdivided becomes the alveolus.
- 3| A lot of disassemble parts including heart.
- 4| Supplied with base.

Code	Parts	Magnifications
QBB008	7	1x



▶ RESPIRATORY SYSTEM - Larynx

- 1| Shows the structure of the respiratory tract that connects the pharynx to the trachea.
- 2| It contains the vocal cords, formed by elastic folds of its walls..
- 3| It shows the prominent part of the anterior side of the neck, commonly known as "Adam's apple".
- 4| Supplied with base.

Code	Parts	Magnifications
QBB022	4	2.5x



▶ GENITALIA AND PREGNANCY - Placenta

- 1| Made of PVC.
- 2| This model represents a section of the placenta including the umbilical cord with a detailed inner structure, highly vascularized with umbilical and maternal blood vessels and placental villi and septum.

Code	Parts	Magnifications
QBB036	1	1x



▶ GENITALIA AND PREGNANCY - Embryo development

- 1| Made of PVC, natural size.
- 2| Model composed of 8 natural size representations that illustrate the development of human fetus from the 4th week until the 6th month of pregnancy.
- 3| They show a single or twin fetus in normal, transversal or breech positions with the placenta and uterus as well as ovaries and the beginning of the vagina.
- 4| All parts are assembled on the same base.

Code	Parts	Magnifications
QBB037	-	1x





QBB - Models, anatomy

**► GENITALIA AND PREGNANCY - Pregnancy pelvis**

- 1 | Made of PVC, natural size.
- 2 | Represents the female pelvis in the 40th week of pregnancy and the fetus in its normal position previous to birth.
- 3 | The fetus can be taken off for its study.

Code	Parts	Magnifications
QBB038	2	1x

► GENITALIA AND PREGNANCY - Male genital apparatus

- 1 | Made of PVC.
- 2 | Vertical section of genital male apparatus.
- 3 | Composed of the penis, testicles inside the scrotum, deferent conducts and the prostate.
- 4 | A representation of the bladder and the rectal colon are also included..
- 5 | Natural size model placed on a vertical and rotating rod stand.

Code	Parts	Magnifications
QBB020	2	1x

► GENITALIA AND PREGNANCY - Female genital apparatus

- 1 | Made of PVC.
- 2 | Vertical section of the female genital apparatus in charge of producing female gametes.
- 3 | It shows different parts as vagina, uterus, ovaries and Fallopian tubes as well as bladder and rectal colon.
- 4 | Natural size model placed on a vertical and rotating rod stand.

Code	Parts	Magnifications
QBB021	2	1x

► DENTAL MODELS - Mouth cavity

- 1 | Specially designed to show how to clean and protect your teeth appropriately.
- 2 | They are represented the following parts: tongue, teeth, gingival, jawbones and palate.
- 3 | Supplied with base.

Code	Parts	Magnifications
QBB040	2	2x

▶ QBB - Models, anatomy

▶ DENTAL MODELS - Canine and molar

- 1 | Canine and molar with double root.
- 2 | Both have two detachable parts that show a longitudinal section of crown and root.
- 3 | Supplied with base.

Code	Parts	Magnifications
QBB031	4	10x



▶ DENTAL MODELS - Upper incisor

- 1 | Upper incisor, cross section of the crown and longitudinal section of the root.
- 2 | Supplied with base.

Code	Parts	Magnifications	Dimensions
QBB032	2	8x	24x11x11 cm



▶ DENTAL MODELS - Upper premolar

- 1 | Upper twin-root molar with caries.
- 2 | Cross section of the crown and the root.
- 3 | Supplied with base.

Code	Parts	Magnifications	Dimensions
QBB033	2	8x	27x10x12 cm



▶ DENTAL MODELS - Half lower mandible

- 1 | Right half of the lower jaw with second dentition showing several caries.
- 2 | A part can be open to show blood supply and dental roots.
- 3 | Supplied with base.

Code	Parts	Magnifications	Dimensions
QBB034	2	1x	7x10x2 cm



▶ DENTAL MODELS - Upper molar, 3 roots

- 1 | Upper triple-root molar with caries.
- 2 | Longitudinal section of the crown and the root.
- 3 | Supplied with base.

Code	Parts	Magnifications	Dimensions
QBB035	2	6x	24x12x12 cm





QBB - Models, anatomy



▶ OTHER ORGANS - Heart



- 1 | Represented arteries, capillary blood vessels, venules, veins, atriums and ventricles.
- 2 | Disassembled in 3 parts: vaorta and pulmonary arteries and the heart.
- 3 | Supplied with base.

Code	Parts	Magnifications
QBB005	3	3x

▶ OTHER ORGANS - Stomach



- 1 | The upper half of the model is removable.
- 2 | They are represented the layers of the stomach wall, inner part or the oesophagus, cardiac part of the stomach, upper part of the duodenum, vessels and nerves.
- 3 | Supplied with base.

Code	Parts	Magnifications
QBB023	2	2x

▶ ADULT TORSO CPR MANIKIN



- 1 | We present this new range of CPR models suitable for teaching and learning the technique of Cardiopulmonary resuscitation (CPR) in health training centers.
- 2 | Allows the application of artificial breath and chest compression.
- 3 | With visual and sound alarm of both the correct position of hands and applied intensity in chest compression.
- 4 | Kit of accessories and spare parts included with the model:
 - 1 piece mouth/nose
 - 5 disposable airways
 - 1 box of hygienic applications (C/50 pcs)
 - 1 working surface
 - 1 cover for model storage and transport

Code	Dimensions
QBB039	80x30x40 cm



QBG - Botany



▶ Plant cell



- 1 | Longitudinal section that shows the internal structure of the plant cell.
- 2 | It represents the compound for the nucleus of the most representative organelles (vacuoles, chloroplasts, ER and mitochondria).
- 3 | Shows the external morphology of cell union between adjacent cells, through the cell wall and its primary pores on intermembrane connection that constitute the plasmodesmata.

Code	Parts	Magnifications
QBG004	1	10000x

▶ QBG - Botany



▶ Dicotyledon stem

- 1| Cross and longitudinal section of the root.
- 2| It shows the vascular bundles (xylem, phloem, procambium), the cortex and the parenchyma (medullary and interfascicular) as well as outer epidermis.

Code	Parts	Magnifications
QBG001	1	125x



▶ Longitudinal section of root

- 1| Longitudinal section of root that shows its internal and external morphology .
- 2| Represents division zones (calyptra and apical meristem) elongation and differentiation (apical hair).
- 3| It allows to distinguish from outside to inside: epidermis, cortical parenchyma, vascular beam, xylem and phloem.

Code	Parts	Magnifications
QBG002	1	100x



▶ Peach blossom

- 1| Represents the essentials parts of a flower: receptacle, calyx, corolla, stamens, filament and pistils.
- 2| Supplied with base.

Code	Parts	Magnifications
QBG003	1	20x



▶ Leaf section

- 1| Cross and longitudinal section of the leaf.
- 2| Are represented the upper epidermis, palisade mesophyll, vascular tissue, spongy mesophyll, lower epidermis and stoma.
- 3| Supplied with base.

Code	Parts	Magnifications
QBG005	1	700x

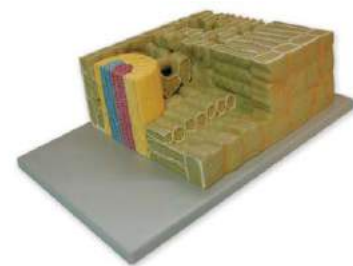

▶ Vascular bundles

- 1| Cross and longitudinal section of the vascular bundles.
- 2| Represents the different sections numerically (parenchyma, xylem, phloem, cambium, fiber, etc).
- 3| Supplied with base.

Code	Parts	Magnifications
QBG006	1	550x





QBG - Botany

Nahita

► Fertilization of angiosperm



- 1 | Sample with the male organ in detail (androecium) and female (gynoecium) of an angiosperm flower.
- 2 | It shows the stamens, with pollen and the carpel (stigma, style, ovary and ova).

Code	Parts	Magnifications
QBG007	1	300x



QBN - Zoology

Nahita

► Animal cell

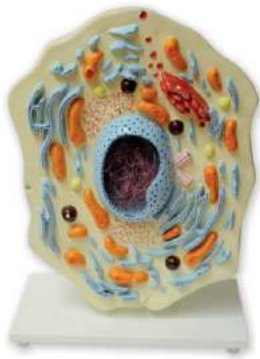

- 1 | Longitudinal section which provide you an overview of the general morphology commonly present in animal eukaryotic cell.
- 2 | Includes the nucleus and its general genetic content (DNA / RNA).
- 3 | It shows various organelles and elements presents in the cytoplasmic space (smooth and rough endoplasmic reticulum, Golgi, mitochondria, vesicles, lysosomes, ribosomes, centrioles, etc.).

Code	Parts	Magnifications
QBN001	1	10000x

► Ameba



- 1 | Longitudinal section of an unicellular organism called Amoeba proteus.
- 2 | It allows to distinguish morphology sections as the plasmatic membrane, digestive and contractile vacuoles and its characteristic pseudopods used to feed and to move in the medium.

Code	Parts	Magnifications
QBN002	1	10000x

► Mitosis



- 1 | Made of PVC.
- 2 | Illustrates the division of the nucleus (mitosis) in a dividing cell at different times, all of them included within the four stages of the nuclear division: prophase, metaphase, anaphase and telophase.
- 3 | All parts are assembled on the same base.

Code	Parts	Magnifications
QBN003	1	10000x

▶ QBN - Zoology



▶ Earthworm dissection

- 1| Longitudinal section of the anterior region of an earthworm (*Lumbricus terrestris*).
- 2| Transversal section raised .
- 3| The digestive tube can be dismantled.
- 4| Supplied with base.

Code	Parts	Magnifications
QBN004	2	15x



▶ Locust dissection

- 1| Longitudinal section of locust (*Locusta migratoria*).
- 2| With the following parts to disassemble: legs, antenna, buccal apparatus, wings and digestive system.
- 3| Supplied with base.

Code	Parts	Magnifications
QBN005	6	10x



▶ Dog skeleton

- 1| Assembled on a rectangular base of black plastic.
- 2| It has two vertical metal supports that join the skeleton in the thoracic and lumbar vertebrae respectively.
- 3| The tail (caudal vertebrae) is detachable as well as the head.
- 4| Mobile jaw.

Code	Parts	Dimensions
QBN006	1	53x20x30 cm



▶ Cat skeleton

- 1| Assembled on a rectangular base of black plastic.
- 2| It has two vertical metal supports that join the skeleton in the thoracic and lumbar vertebrae respectively.
- 3| The tail (caudal vertebrae) is detachable as well as the head.
- 4| Mobile jaw.

Code	Parts	Dimensions
QBN007	1	47x20x27 cm



▶ QBQ - Astronomy



▶ Solar system

- 1| Sun+9 planet+terrestrial moon, lighting of the Sun
- 2| Gyrotary mechanism of the planets with wooden support

Code	Magnifications	Parts
QBQ001	20x	1

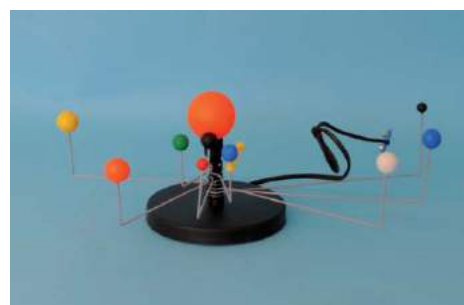

▶ QBR - Molecular kits



▶ CHART 1: "Number of atoms"

Code	Carbon	Hydrogen	Oxygen	Nitrogen	Sulfur	Phosphorus	Halogens	Metal
QBR003	20	30	6	6	2	2	8	2
QBR004	12	14	22	10	13	7	8	14
QBR005	66	105	40	34	2	6	-	2

▶ CHART 2: "Number of bonds"

Code	Short (white)	Medium (gray)	Long (grey)	Non-visible (grey)
QBR003	50	41	12	-
QBR004	-	50	36	-
QBR005	100	-	-	60

▶ Organic Chemistry molecular kit, student



- 1 | It is composed of a total of 50 pcs of atoms for the representation of simple molecules of organic chemistry
- 2 | The kit is supplied in a box for storage and with a tool for detaching unions.
- 3 | . The kit is composed of: Carbon (20 pieces), Hydrogen (30 pieces), Oxygen (6 pieces), Nitrogen (6 pieces), Sulfur (2 pieces), Phosphorus (2 pieces), Halogens (8 pieces), Metal (2 pieces).
- 4 | Bonds: short (50, white colour), medium (41, grey colour), long (12, grey colour)

Code

QBR003

▶ Organic Chemistry molecular kit, teacher



- 1 | It is composed of a total of 97 pcs of atoms for the representation of simple molecules of organic chemistry
- 2 | The kit is supplied in a box for storage and with a tool for detaching unions.
- 3 | The kit is composed of: Carbon (12 pieces), Hydrogen (14 pieces), Oxygen (22 pieces), Nitrogen (10 pieces), Sulfur (13 pieces). Halogens (8 pieces), Meta (14 pieces).
- 4 | Bonds: short (50, white colour), long (36, grey colour)

Code

QBR004

▶ Biochemistry molecular kit, teacher



- 1 | It is composed of a total of 255 pcs of atoms for the representation of biochemistry molecules such as amino acids, peptides, polysaccharides, purines, phospholipids, nucleotides, etc
- 2 | The kit is supplied in a box for storage and with a tool for detaching unions.
- 3 | The kit is composed of: Carbon (66 pieces), Nitrogen (34 pieces), Metal (2 pieces), Hydrogen (105 pieces), Oxygen (40 pieces), Sulfur (2 pieces), Phosphorus (6 pieces).
- 4 | Bonds: short (100, white colour), not visible (60, grey colour)

Code

QBR005

▶ QGB - Animal histology

▶ Cytology

Code	Description
QGB001	Mitosis horse <i>Ascaris</i> eggs, SEC.
QGB002	Locusta testicle, SEC.)
QGB003	Giant chromosomes of salivary gland, W.M.
QGB077	Human chromosomes in blood, male and female

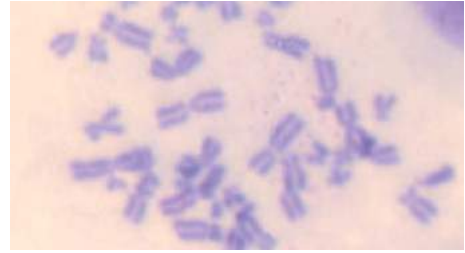

▶ Basic tissue types

Code	Description
QGB011	Simple flat epithelium, W.M.
QGB012	Stratified flat epithelium, SEC.
QGB013	Adipose tissue, SEC.
QGB014	Loose connective tissue, W.M.
QGB015	Cartilage, SEC.
QGB016	Compact bone, W.M.
QGB017	Human blood smear
QGB018	Frog blood smear
QGB019	Fish blood smear
QGB020	Snake blood smear
QGB021	Smooth muscle, teared, W.M.
QGB022	Skeletal muscle, L.S. and C.S.
QGB023	Cardiac muscle, SEC.
QGB058	Gallus domestica blood smear
QGB059	Tendon, dense connective tissue, L.S.
QGB066	Mouse tail, C.S.
QGB078	Bird blood smear
QGB079	Ciliated epithelium, SEC.

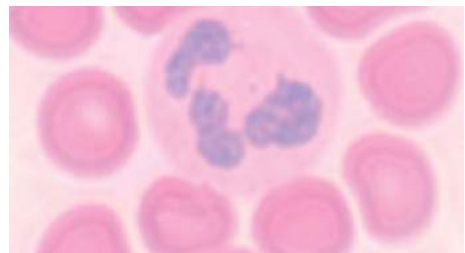
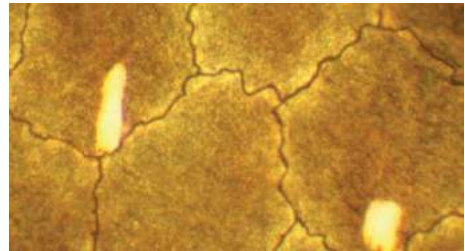

▶ Organs and systems

Code	Description
Circulatory system	
QGB046	Artery and vein, C.S.
QGB074	Frog heart, C.S.
QGB075	Frog artery, C.S.
QGB076	Frog vein, C.S.
Respiratory system	
QGB043	Lung, SEC.
QGB044	Lung, blood irrigation, SEC.
QGB045	Smoking lung, human, SEC.
QGB063	Trachea, C.S.
QGB064	Trachea, L.S.
Gastrointestinal system	
QGB005	Frog small intestine, s.t.
QGB033	Esophagus, s.t.
QGB034	Parotid, SEC.
QGB035	Stomach wall, SEC.
QGB036	Small intestine, s.t.
QGB037	Jejunum, SEC.
QGB039	Large intestine, s.t.
QGB040	Pancreas, SEC.
QGB042	Gallbladder, SEC.
QGB061	Pig liver, SEC.
QGB062	Rabbit liver, SEC.
QGB070	Frog stomach wall, SEC.
QGB071	Frog liver, SEC.
QGB073	Frog large intestine, SEC.

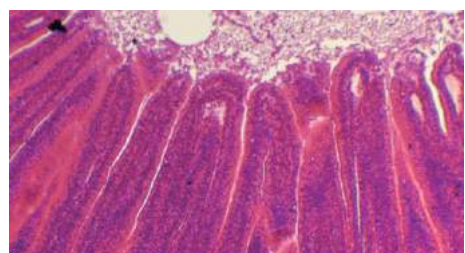
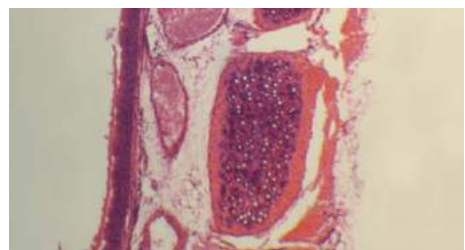
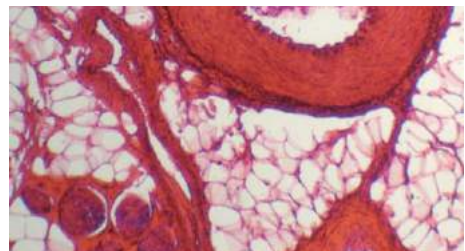



QGB - Animal histology



▶ Organs and systems

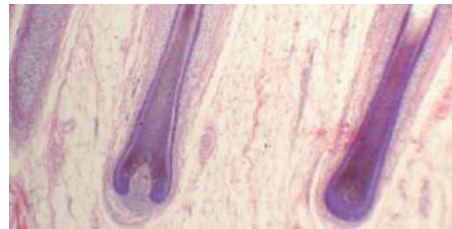
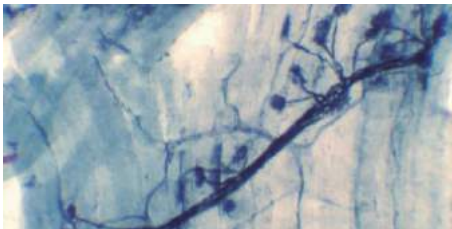
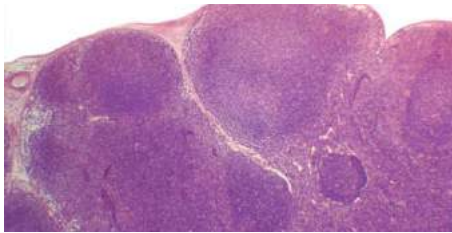
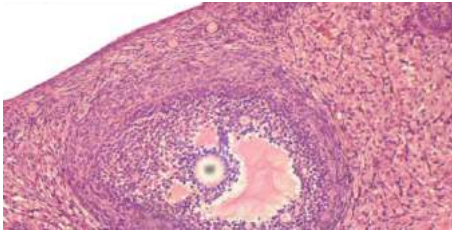

Code	Description
Reproductive system and embryonic development	
QGB006	Frog egg, SEC.
QGB007	Two cell stage frog egg, SEC.
QGB008	Cleavage stage frog egg, SEC.
QGB009	Frog blastula, SEC.
QGB010	Frog gastrula, SEC. .
QGB050	Rabbit ovary, SEC. .
QGB051	Human sperm smear
QGB052	Fallopian tube, C.S.
QGB053	Mammary gland, active phase, SEC.
QGB065	Rabbit testicle, SEC.
QGB067	Frog sperm smear
QGB068	Frog testicle, SEC.
QGB069	Frog ovary, SEC.
Urinary system	
QGB047	Kidney, L.S.
QGB048	Kidney, blood irrigation, SEC.
QGB049	Urinary bladder, SEC.
QGB072	Frog kidney, L.S.
Immune system	
QGB038	Appendix section
QGB041	Spleen, SEC.
QGB054	Lymph node, sec
Nervous system and sense organs	
QGB004	Frog skin, W.M.
QGB024	Rabbit spinal cord, C.S.
QGB025	Brain, rabbit, silver staining, SEC.
QGB026	Cerebellum, rabbit, silver staining, SEC.
QGB027	Cerebellum, rabbit, HE, SEC.
QGB028	Motor nerve endings, rabbit, W.M.
QGB029	Motor neuron, W.M.
QGB030	Brain, human, HE, SEC.
QGB031	Brain, human, silver staining, SEC.
QGB032	Taste buds, rabbit, SEC.
QGB055	Eyeball, L.S.
QGB056	Human skin, sweat glands, SEC.
QGB057	Human skin, hair follicles, SEC.
QGB060	Tongue with filiform papillae, L.S.



QGF - Plant histology



▶ Alga

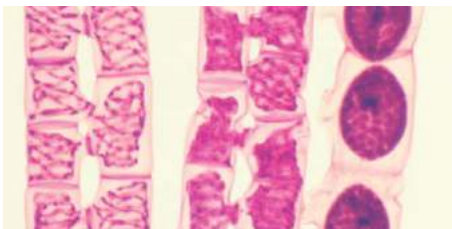

Code	Description
QGF010	Chlamydomonas, W.M.
QGF011	Volvox, W.M.
QGF012	Spirogyra conjugation, W.M.
QGF013	Porphyra, W.M.
QGF023	Brown alga leaf, C.S.
QGF116	Spirogyra vegetative mass, W.M.
QGF125	Blue-green alga, W.M.
QGF129	Oscillatoria, W.M.
QGF130	Euglena, W.M.

▶ Fungi and lichens

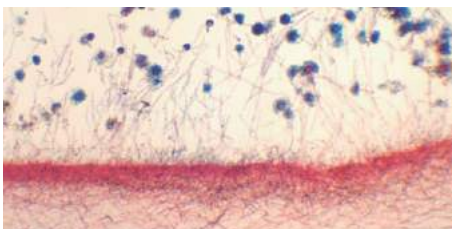

Code	Description
QGF004	Mushroom, SEC.
QGF005	Rhizopus nigricans, W.M.
QGF006	Penicillium, W.M.
QGF007	Aspergillus, W.M.
QGF008	Yeast, W.M.
QGF009	Lichen, SEC.

QGF - Plant histology

Ferns

Code	Description
QGF024	Fern prothallus w/young sporophyte, W.M.
QGF025	Fern prothallus w/antheridium, C.S.
QGF026	Fern prothallus w/archegonium, C.S.
QGF117	Fern sorus, SEC.
QGF118	Fern subterraneous stem, C.S.
QGF128	Fern sporangium, W.M.

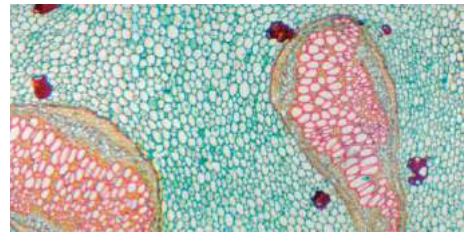

Moss and liverworts

Code	Description
QGF014	Marchantia thallus, s.t.
QGF015	Marchantia sorus, s.l.
QGF016	Marchantia antheridium, s.l.
QGF017	Marchantia archegonia, s.l.
QGF018	Moss leaf, m.e.
QGF019	Moss, m.e.
QGF020	Moss protonema, m.e.
QGF021	Moss antheridium, s.l.
QGF022	Moss archegonia, s.l.
QGF122	Moss stem, s.t.

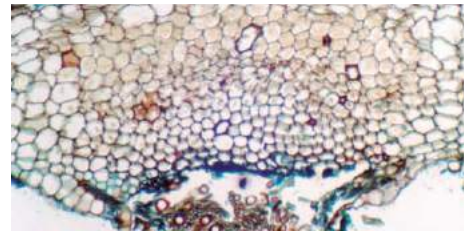

Gymnosperms

Code	Description
QGF027	Pine leaf, s.t.
QGF028	1 year old pine stem, s.t.
QGF029	10 years old pine stem, s.t.
QGF030	Male pine cone, s.l.
QGF031	Female pine cone, s.l.
QGF032	Pine pollen, m.e.

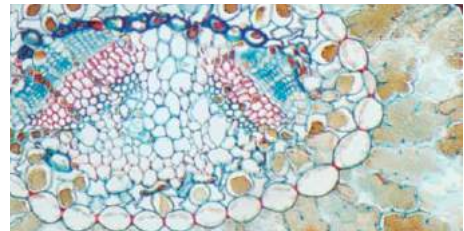

Angiosperms- basic structures and tissues

Code	Description
QGF046	Mitosis onion root tip, s.l.
QGF051	Punta de raíz de Narcissus tazetta (narciso), s.l.
QGF065	Stem with collenchyma, C.S.
QGF066	Stem with sclerenchyma, C.S.
QGF067	Stem with lenticels, C.S.
QGF068	Morus alba petiole, abscission layer, L.S.
QGF069	Stem with sieve tubes, L.S.
QGF070	Stem with intercalary meristem, L.S.
QGF071	Syringo stem tip, L.S.
QGF072	Hydrilla verticillata stem tip, L.S.
QGF073	Onion stomata, W.M.
QGF074	Triticum aestivum stomata, W.M.
QGF075	Oryza sativa stomata, W.M.
QGF076	Vicia faba stomata, s.e.
QGF077	Commelina communis stomata, W.M.
QGF078	Three types of plant leaves, C.S.
QGF080	Nerium indicum leaf, sunken stomata, C.S.
QGF086	Osmanthus fragrans leaf, stone cells, C.S.
QGF091	Sunken plant leaf, aerenchyma, C.S.
QGF105	Stone cells, pear fruit, SEC.
QGF106	Plasmodesmata, endosperm SEC.
QGF113	Meiosis, lily anther, C.S.
QGF126	Persimmon pulp cells
QGF127	Sugarcane armpit bud, C.S.
QGF132	Solanum tuberosum tuber, SEC.

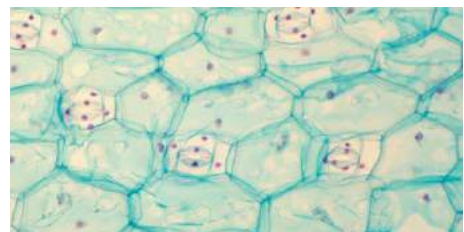
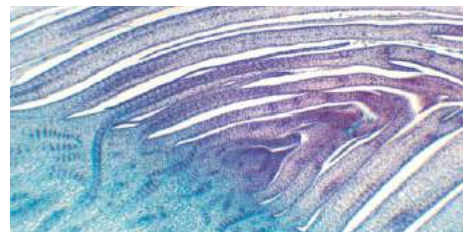
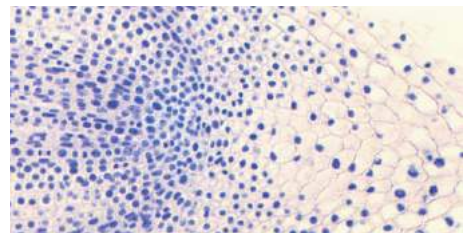



QGF - Plant histology



▶ Angiospermas - Leaves

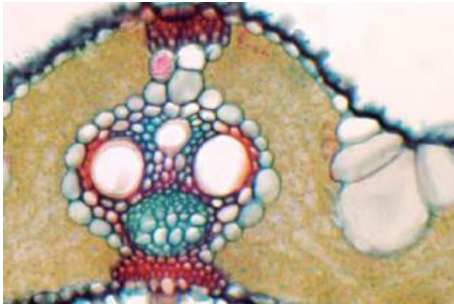

Code	Description
QGF079	Ficus leaf, sunken stomata, C.S.
QGF081	Ligustrum lucidum leaf, C.S.
QGF082	Jasminum nudiflorum leaf, C.S.
QGF083	Lily leaf, C.S.
QGF084	Coffee leaf, C.S.
QGF085	Camellia sinensis leaf, C.S.
QGF087	Triticum aestivum leaf, C.S.
QGF088	Oryza sativa leaf, C.S.
QGF089	Corn leaf, C.S.
QGF090	Narzissus tazetta leaf, C.S.
QGF092	Fig leaf, C.S.
QGF093	Privet leaf, C.S.
QGF094	Sugarcane leaf, C.S.
QGF111	Mono and dicotyledon leaves, C.S.
QGF003	Nicotina tabacum leaf C.S.

▶ Angiospermas - Stems

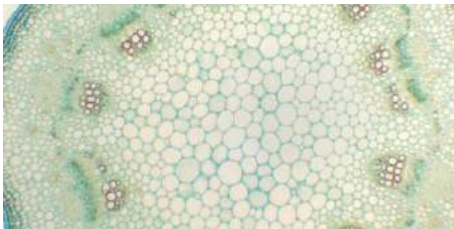

Code	Description
QGF052	Helianthus young stem, L.S.
QGF053	Sambucus williamsii stem, C.S.
QGF054	Hibiscus syriacus stem, C.S.
QGF055	Tilia 1 year stem, C.S.
QGF056	Arachis hypogaea young stem, C.S.
QGF057	Arachis hypogaea old stem, C.S.
QGF058	Triticum aestivum stem, C.S.
QGF059	Corn stem, C.S.
QGF060	Corn stem, L.S.
QGF061	Medicago sativa stem, C.S.
QGF062	Orange stem, C.S.
QGF063	Nerium indicum stem, C.S.
QGF064	Pelargonium hortorum stem, C.S.
QGF110	Mono and dicotyledon stems, C.S.
QGF112	Tilia 1, 2 and 3 year stem, C.S.
QGF115	Herbage and woody stem, C.S.
QGF119	Helianthus stem, C.S.
QGF120	Gossypium young stem, C.S.
QGF121	Gossypium old stem, C.S.
QGF123	Sugarcane stem, C.S.
QGF001	Ricinus comunis old stem C.S.
QGF002	Pyrus s.p. stem, C.S.

▶ Angiospermas - Reproductive organs and seeds

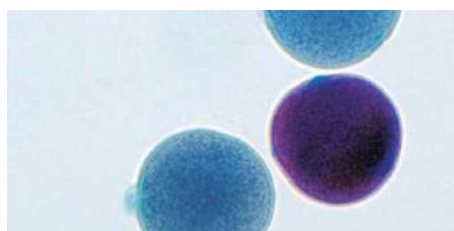
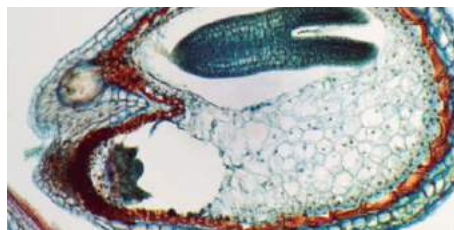

Code	Description
QGF095	Lily pollen, W.M.
QGF096	Lily anther, C.S.
QGF097	Lily ovary, C.S.
QGF098	Narcissus tazetta ovary, C.S.
QGF099	Helianthus ovary, c.l.
QGF100	Capsella young embryo, SEC.
QGF101	Capsella middle embryo, SEC.
QGF102	Capsella mature embryo, SEC.
QGF103	Triticum aestivum seed, L.S.
QGF104	Corn seed, L.S.
QGF107	Capsicum pericarp, SEC.
QGF108	Luffa cylindrica pollen, W.M.
QGF114	Lilium embryo sac development
QGF133	Germinated pollen, W.M.

▶ QGF - Plant histology



▶ Angiospermas - Roots

Code	Description
QGF033	Cuscuta chinensis parasitic root, C.S.
QGF034	Helianthus old root, C.S.
QGF035	Ranunculus japonicus root, C.S.
QGF036	Vicia faba young root, c.t.
QGF037	Vicia faba old root, s.t.
QGF038	Vicia faba lateral root, C.S.
QGF039	Ipomoea batatas root, C.S.
QGF040	Iris root, C.S.
QGF041	Gossypium root, C.S.
QGF042	Glycine max root, C.S.
QGF043	Glycine max root nodule, C.S.
QGF044	Raphanus sativus fleshy root, C.S.
QGF045	Daucus carota root, C.S.
QGF047	Onion root, C.S.
QGF048	Corn root, C.S.
QGF049	Oryza sativa root, C.S.
QGF050	Earthpea root, C.S.
QGF109	Mono and dicotyledon roots, C.S.
QGF124	Mono and dicotyledon roots, C.S.
QGF131	Allium tuberosum root, C.S.

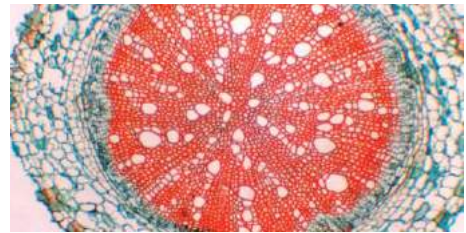
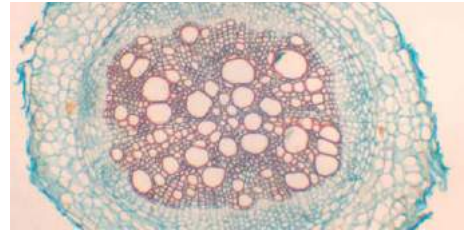

▶ QGJ - Zoology



▶ Bacteria and protozoa

Code	Description
QGJ001	Paramecium, W.M.
QGJ002	Unicellular animal, W.M.
QGJ046	Three types of bacteria smear

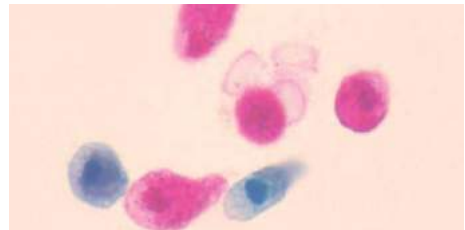

▶ Cnidaria

Code	Description
QGJ003	Hydra W.M.
QGJ004	Hydra spermary, C.S.
QGJ005	Hydra ovary, C.S.
QGJ009	Hydra, L.S.
QGJ047	Hydra, C.S.



▶ Aschelminthes, molluscs and annelids

Code	Description
QGJ013	Ascaris male, C.S.
QGJ014	Ascaris female, C.S.
QGJ015	Ascaris male and female, C.S.
QGJ052	Mussel gills, W.M.
QGJ016	Hirudo niponia, W.M.
QGJ017	Earthworm, C.S.

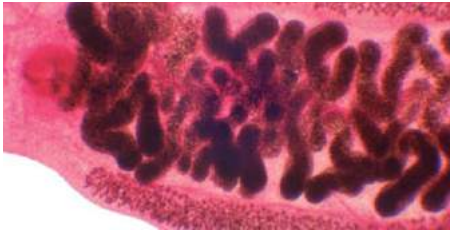

**▶ Plathelminthes**

Code	Description
QGJ010	Turbellaria, W.M.
QGJ011	Turbellaria, C.S.
QGJ012	Bladder worm, W.M.
QGJ028	Schistosoma miracidium, W.M.
QGJ029	Schistosoma male, W.M.
QGJ030	Schistosoma female, W.M.
QGJ031	Schistosoma male anf female conjugation, W.M.
QGJ048	Turbellaria, digestive tube, W.M.
QGJ049	Clonorchis sinensis, W.M.
QGJ064	Schistosoma eggs, W.M.
QGJ065	Schistosoma cercaria, W.M.

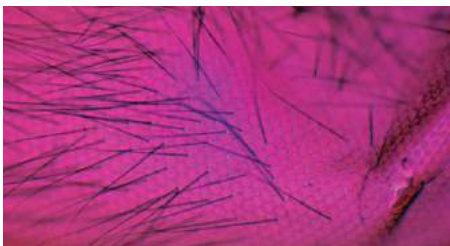
▶ Arthropods

Code	Description
QGJ006	Daphnia, W.M.
QGJ007	Siphonaptera, W.M.
QGJ008	Aphis, W.M.
QGJ018	Male mosquito mouth parts, W.M.
QGJ019	Female mosquito mouth parts, W.M.
QGJ020	House fly mouth parts, W.M.
QGJ021	Honeybee mouth parts, W.M.
QGJ022	Butterfly mouth parts, W.M.
QGJ023	Grasshopper mouth parts, W.M.
QGJ024	Periplaneta mouth parts, W.M.
QGJ025	Insect compund eye, SEC.
QGJ033	Caterpillar
QGJ034	Spider, W.M.
QGJ035	Mosquito larva, W.M.
QGJ036	House fly, W.M.
QGJ037	Female mosquito, W.M.
QGJ038	Male mosquito, W.M.
QGJ039	Fruit fly, W.M.
QGJ040	Ant, W.M.
QGJ041	Insect digging leg, W.M.
QGJ042	Insect walking leg, W.M.
QGJ043	Insect swimming leg, W.M.
QGJ044	Insect leaping leg, W.M.
QGJ045	Insect pollinating leg, W.M.
QGJ050	Tetranychus telarius, W.M.
QGJ051	Insect compound eye, W.M.
QGJ054	House fly wing, W.M.
QGJ055	Butterfly wing, W.M.
QGJ056	Honeybee wing, W.M.
QGJ057	House fly leg, W.M.
QGJ058	Honeybee front and back leg, W.M.
QGJ059	House fly antenna, W.M.
QGJ060	White ant antenna, W.M.
QGJ061	Mosquito antenna, W.M.
QGJ062	Chafer antenna, W.M.
QGJ063	Honeybee antenna, W.M.

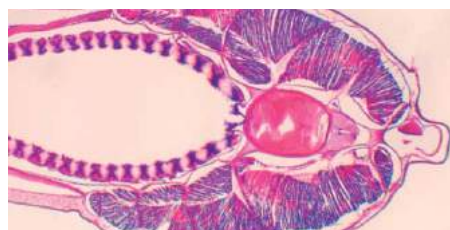
▶ Chordates and vertebrates

Code	Description
QGJ026	Branchiostoma belcheri, W.M.
QGJ027	Branchiostoma belcheri, pharynx, C.S.
QGJ032	Bird feather, W.M.
QGJ053	Fish scale, W.M.

▶ QGM - Minerals

Code	Description
QGM001	Schiste
QGM002	Micaschiste 2 type
QGM003	Granite anatexis
QGM004	Gneiss
QGM005	Basalt 2 type
QGM006	Gabbro
QGM007	Andesite
QGM008	Rhyolite

▶ QGR - Slide sets

▶ Histology and organography

1 | Aimed at studying and recognizing the most important animal and plant tissues, and their organization and specialization to form different organs.

2 | Supplied in a plastic box that can hold 25 slides, to ensure their protection and durability.

1_ Animal histology

Code	Set	N° slides
QGR001	Animal histology	24

1 | Includes slides of blood, epithelial tissue, connective tissue, bone, cartilage, muscle and nerve tissue.

QGB017 - Human blood smear	QGB073 - Frog large intestine, C.S.
QGB018 - Frog blood smear	QGB063 - Trachea, C.S.
QGB019 - Fish blood smear	QGB015 - Cartilage, SEC.
QGB020 - Snake blood smear	QGB016 - Compact bone, W.M.
QGB058 - Gallus domestica blood smear	QGB066 - Mouse tail, C.S.
QGB014 - Loose connective tissue, W.M.	QGB047 - Kidney, L.S.
QGB059 - Tendon, dense connective tissue, L.S.	QGB021 - Smooth muscle, teared, W.M.
QGB057 - Human skin hair follicles, SEC.	QGB042 - Vesícula biliar, SEC.
QGB056 - Human skin sweat glands, SEC.	QGB022 - Skeletal muscle, L.S. and C.S.
QGB012 - Stratified flat epithelium, SEC.	QGB023 - Cardiac muscle, SEC.
QGB011 - Simple flat epithelium, W.M.	QGB024 - Rabbit spinal cord, C.S.
QGB036 - Small intestine, C.S.	QGB028 - Motor nerve endings, rabbit, W.M.

2_ Plant histology

Code	Set	N° slides
QGR002	Plant histology	24

1 | Includes slides of meristem, parenchyma, cholenchyma, sclerenchyma, xylem, phloem and protective tissue.

:

QGF046 - Mitosis onion root tip, S.L.	QGF081 - Ligustrum lucidum leaf, C.S.
QGF105 - Stone cells, pear, SEC.	QGF076 - Vicia faba stomata, s.e.
QGF051 - <i>Narcissus tazetta</i> , root tip S.L.	QGF132 - Solanum tuberosum tuber, SEC.
QGF086 - Osmanthus fragrans leaf, stone cells, C.S.	QGF077 - Commelina communis stomata, W.M.
QGF071 - Syringo stem tip, L.S.	QGF091 - Sunken plant leaf, aerenchyma, C.S.
QGF082 - Jasminum nudiflorum leaf, C.S.	QGF088 - Oryza sativa leaf, C.S.
QGF072 - Hydrilla verticillata stem tip, L.S.	QGF065 - Stem with collenchyma, C.S.
QGF069 - Stem with sieve tubes, L.S.	QGF087 - Triticum aestivum leaf, C.S.
QGF127 - Sugarcane armpit bud, C.S.	QGF053 - Sambucus williamsii stem, C.S.
QGF074 - Triticum aestivum stomata, W.M.	QGF080 - Nerium indicum leaf, sunken stomata, C.S.
QGF070 - Stem with intercalary meristem, L.S.	QGF066 - Stem with sclerenchyma, C.S.
QGF075 - Oryza sativa stomata, W.M.	QGF092 - Fig leaf, C.S.



► Histology and organography

3_ Animal organography

Code	Set	Nº slides
QGR003	Animal organography	25

1 | Includes slides of mammal skin, digestive, urinary, respiratory, and reproductive apparatus, lymphoid, circulatory, nervous system and special sense organs.

QGB046 - Artery and vein, C.S.

QGB033 - Esophagus, C.S.

QGB035 - Stomach wall, SEC.

QGB037 - Jejunum, SEC.

QGB039 - Large intestine, C.S.

QGB040 - Pancreas, SEC.

QGB061 - Pig liver, SEC.

QGB042 - Gallbladder, SEC.

QGB041 - Spleen, SEC.

QGB054 - Spleen, SEC.

QGB047 - Kidney, S.L.

QGB048 - Kidney blood irrigation, SEC.

QGB049 - Urinary bladder, SEC.

QGB063 - Trachea, C.S.

QGB064 - Trachea, L.S.

QGB043 - Lung, SEC.

QGB044 - Lung, blood irrigation, SEC.

QGB050 - Rabbit ovary, SEC.

QGB065 - Rabbit testicle, SEC.

QGB024 - Rabbit spinal cord, C.S.

QGB057 - Human skin, hair follicles, SEC.

QGB056 - Human skin, sweat glands, SEC.

QGB060 - Tongue with filiform papillae, L.S.

QGB032 - Taste buds, rabbit, SEC.

QGB055 - Eyeball, L.S.

4_ Plant organography

Code	Set	Nº slides
QGR004	Plant organography	25

1 | Includes slides of gymnosperm and angiosperm (monocot and dicot) stems, roots, leaves and reproductive organs.

QGF028 - 1 year old pine stem, C.S.

QGF029 - 10 years old pine stem, C.S.

QGF112 - Tilia 1, 2 and 3 year stems, C.S.

QGF110 - Mono and dicotyledon stems, C.S.

QGF115 - Herbage and woody stem, C.S.

QGF056 - Arachis hypogaea young stem, C.S.

QGF057 - Arachis hypogaea old stem, C.S.

QGF067 - Stem with lenticels, C.S.

QGF109 - Mono and dicotyledon roots, C.S.

QGF033 - Cuscuta chinensis parasitic root, C.S.

QGF039 - Ipomoea batatas root, C.S.

QGF045 - Daucus carota root, C.S.

QGF035 - Ranunculus japonicus root, C.S.

QGF042 - Glycine max root, C.S.

QGF038 - Vicia faba lateral root, C.S.

QGF049 - Oryza sativa root, C.S.

QGF043 - Glycine max root nodule, C.S.

QGF027 - Hoja de pino, C.S.

QGF111 - Mono and dicotyledon leaves, C.S.

QGF078 - Three types of plant leaves, C.S.

QGF068 - Morus alba petiole, abscission layer, S.L.

QGF097 - Lily ovary, C.S.

QGF098 - Narcissus tazetta ovary, C.S.

QGF099 - Helianthus ovary, S.L.

QGF096 - Lily anther, C.S.

► Reproduction and genetics

1 | Aimed at studying the animal and plant reproduction processes; from the apparently simple division of a cell by the mechanism of mitosis to the complex embryonic development of superior animals and plants..

2 | Supplied in a plastic box that can hold 25 slides, to ensure their protection and durability.

1_ 2- Genetics

Code	Set	Nº slides
QGR006	Genetics	5

1 | Includes slides of human and politenic chromosomes, animal and vegetal mitosis and meiosis.

QGB077 - Human chromosomes in blood, male and female.

QGB001 - Mitosis horse Ascaris eggs, C.S.

QGB003 - Giant chromosomes of salivary gland, W.M.

QGF113 - Meiosis, lily anther, C.S.

QGF046 - Mitosis onion root tip, S.L.

▶ QGR - Colecciones



▶ Reproduction and genetics

2_ Animal and plant rep.

Code	Set	Nº slides
QGR005	Animal and plant rep.	24

1 | Includes preparations of the gametogenesis process And early stages of the embryonic development of amphibians, Sexual reproduction of gymnosperms and angiosperms. Composed by :

QGB051 - Human sperm smear	QGF095 - Lily pollen, M.E.
QGB067 - Frog sperm smear	QGF108 - Luffa cylindrical pollen, M.E.
QGB068 - Frog testicle, SEC.	QGF133 - Germinated pollen, M.E.
QGB069 - Frog ovary, SEC.	QGF114 - Liliium embryo sac development
QGB006 - Frog egg, SEC.	QGF100 - Capsella young embryo, SEC.
QGB007 - Two cell stage frog egg, SEC.	QGF101 - Capsella middle embryo, SEC.
QGB008 - Cleavage stage frog egg, SEC.	QGF102 - Capsella mature embryo, SEC.
QGB009 - Frog blastula, SEC.	QGF103 - Triticum aestivum (wheat) seed, S.L.
QGB010 - Frog gastrula, SEC.	QGF104 - Corn seed, S.L.
QGF032 - Pine pollen, M.E.	QGF126 - Persimmon pulp cells
QGF030 - Male pine cone, S.L.	QGF107 - Capsicum pericarp, SEC.
QGF031 - Female pine cone, S.L.	

▶ Zoology

1 | Aimed at the study of the different evolutionary groups that form the animal kingdom, with special emphasis in the animal group with the highest diversification and specialization: insects.

2 | Supplied in a plastic box to ensure protection and durability of the slides.

1_ Insects anatomy

Code	Set	Nº slides
QGR007	Insects anatomy	24

1 | Insects anatomy. Composed of:

QGJ041 - Insect digging leg	QGJ023 - Grasshopper mouth parts, m.e.
QGJ042 - Insect walking leg, m.e.	QGJ024 - Periplaneta (cockroach) mouth parts, m.e.
QGJ043 - Insect swimming leg, m.e.	QGJ059 - House fly antenna, m.e.
QGJ044 - Insect leaping leg, m.e.	QGJ060 - Ant antenna, m.e.
QGJ045 - Insect pollinating leg, m.e.	QGJ061 - Mosquito antenna, m.e.
QGJ057 - House fly leg, m.e.	QGJ062 - Beetle antenna, m.e.
QGJ058 - Honey front and hind legs, m.e.	QGJ063 - Honeybee antenna, m.e.
QGJ018 - Male mosquito mouth parts, m.e.	QGJ054 - House fly wing, m.e.
QGJ019 - Female mosquito mouth parts, m.e.	QGJ055 - Butterfly wing, m.e.
QGJ020 - House fly mouth parts, m.e.	QGJ056 - Honeybee wing, m.e.
QGJ021 - Honeybee mouth parts, m.e.	QGJ051 - Insect compound eye, m.e.
QGJ022 - Butterfly mouth parts, m.e.	QGJ025 - Insect compound eye, SEC.

2_ Microorganisms

Code	Set	Nº slides
QGR008	Microorganisms	13

1 | . It includes slides with examples of prokaryotes, fungi and animals and unicellular algae. Composed of:

QGJ001 Paramecium, M.E.	QGF008 Yeast, M.E.
QGJ002 Unicellular animal, M.E.	QGF010 <i>Chlamydomonas</i> , M.E.
QGJ046 Three types of bacteria smear.	QGF130 <i>Euglena</i> , M.E.
QGF125 Blue-green alga, M.E.	QGF011 <i>Volvox</i> , M.E.
QGF005 <i>Rhizopus nigricans</i> , M.E.	QGF012 Spirogyra conjugation, M.E.
QGF006 <i>Penicillium</i> , M.E.	QGF116 Spirogyra vegetative mass, M.E.
QGF007 <i>Aspergillus</i> , M.E.	

**Zoology****3_ Life cycles**

Code	Set	Nº slides
QGR009	Life cyclless	14

1 | Includes slides of the different phases of liverwort, moss and fern life cycles:

QGF014 Marchantia thallus, C.S.	QGF022 Moss archegonium, S.L.
QGF015 Marchantia sorus, SEC.	QGF024 Fern prothallus w/young sporophyte, W.M.
QGF016 Marchantia antheridium, S.L.	QGF117 Fern sorus, SEC.
QGF017 Marchantia archegonium, S.L.	QGF128 Fern sporangium, M.E.
QGF019 Moss, M.E.	QGF025 Fern prothallus w/antheridium, C.S.
QGF020 Moss protonema, M.E.	QGF026 Fern prothallus w/archegonium, C.S.
QGF021 Moss antheridium, S.L.	QGF118 Fern subterranean stem, C.S.

4_ Zoology

Code	Set	Nº slides
QGR010	Zoology	40

1 | Includes slides of representative examples of animal kingdom phylums: protozoa, cnidaria, plathelminths, molluscs, annelids, arthropods and cephalochordata.

QGJ001 - Paramecium, W.M.	QGJ013 - Ascaris male, C.S.
QGJ002 - Unicellular animal, W.M.	QGJ014 - Ascaris female, C.S.
QGJ003 - Hydra W.M.	QGJ015 - Ascaris male and female, C.S.
QGJ004 - Hydra spermary, C.S.	QGB001 - Mitosis horse Ascaris eggs, SEC.
QGJ005 - Hydra ovary, C.S.	QGJ052 - Mussel gills, W.M.
QGJ009 - Hydra, L.S.	QGJ006 - Daphnia, W.M.
QGJ047 - Hydra, C.S.	QGJ007 - Siphonaptera, W.M.
QGJ010 - Turbellaria, W.M.	QGJ008 - Aphis, W.M.
QGJ011 - Turbellaria, C.S.	QGJ050 - Tetranychus telarius, W.M.
QGJ012 - Bladder worm, W.M.	QGJ034 - Spider, m.e.
QGJ028 - Schistosoma miracidium, W.M.	QGJ035 - Mosquito larva, W.M.
QGJ029 - Schistosoma male, W.M.	QGJ036 - House fly, W.M.
QGJ030 - Schistosoma female, W.M.	QGJ037 - Female mosquito, W.M.
QGJ031 - Schistosoma male anf female conjugation, W.M.	QGJ038 - Male mosquito, W.M.
QGJ048 - Turbellaria, digestive tube, W.M.	QGJ039 - Fruit fly, W.M.
QGJ049 - Clonorchis sinensis, W.M.	QGJ040 - Ant, W.M.
QGJ064 - Schistosoma eggs, W.M.	QGJ026 - Branchiostoma belcheri, W.M.
QGJ065 - Schistosoma cercaria, W.M.	QGJ027 - Branchiostoma belcheri, pharynx, C.S.
QGJ016 - Hirudo niponia, W.M.	QGJ032 - Bird feather, W.M.
QGJ017 - Earthworm, C.S.	QGJ053 - Fish scale, W.M.

▶ QL B - Mechanics and fluids



▶ Inclined plane

- 1| The whole structure is made of metal providing a good durability and robustness.
- 2| It is made of 2 metal plates hinged at one end; one of the plates is used as base and the other one as inclined plane.
- 3| The plate acting as inclined plane presents a graduated scale 20-40 cm (divisions of 1 cm) in one side to measure the lineal distance along its length and can be inclined and fixed at any angle from 0 to 40°.
- 4| The instrument is completed with a plastic trolley with hook, a set of weights (including 1x100 g, 1x50 g y 1x20 g) and a pan with a lightweight cord.

Code	Description
QLB001	Inclined plane

▶ Force table

- 1| Made of a thick aluminium circular table, of about 40 cm diameter and covered by scratch resistant black epoxy coating.
- 2| The external rim presents a circular scale graduated from 0° to 360° (divisions every 1° and marked every 10°).
- 3| The table is mounted on a heavy, stable cast metal tripod base.
- 4| Provided with 4 pulleys with clamps that can be attached anywhere along the rim.
- 5| The instrument is supplied complete with a set of cords tied to the centring ring, a detachable pin and 4 sets of slotted masses with hanger. Each set of masses is composed of 1x100 g, 1x10 g, 1x20 g, 1x50 g and one hanger of 100 g.

Code	Description
QLB002	Force table

▶ Free fall apparatus with digital timer

- 1| The instrument consists of an electromagnet mounted on a plastic case to allow releasing a metallic ball fitted on a square sectional rod.
- 2| The instrument includes a precise digital timer with the possibility of programming the time in micro seconds, milliseconds or seconds.
- 3| The time is shown on a 7-segment LED display.
- 4| It also includes all the necessary connection cables.

Code	Description
QLB003	Free fall apparatus with digital timer

▶ Communicating vessels

- 1| It is composed of 4 glass tubes each one of them with different section diameter and shape, connected together at the bottom through a common horizontal glass tube, sealed to a manifold and mounted on a stand.

Code	Description
QLB004	Communicating vessels

▶ Pressure syringes

- 1| Comprises a pair of graduated glass syringes of capacities 50 and 10 cm³ respectively; both having ground pistons with limit stop to prevent their complete ejection from the barrels and providing a cross-sectional area ratio of 3:1 respectively.
- 2| The syringes are mounted on a stable, non-skid metal base with a platform at their top to place the weights; the nozzles of both syringes are connected by a 3-position valve.
- 3| The graduated syringes also permit simple Boyle's Law experiments to be performed.
- 4| Set of weights included: 1x200 g, 1x100 g, 1x50 g, 2x20 g and 1x10 g

Code	Description
QLB005	Pressure syringes

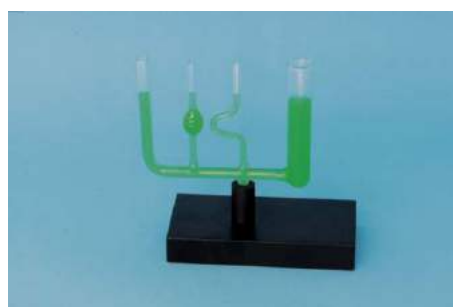



QLB - Mechanics and fluids



Bell jar with hand vacuum pump



- 1 | This instrument is composed of a transparent bell jar and a hand-operated vacuum pump.
- 2 | The bell jar is provided with a robust chamber with a vacuum release valve and a vacuum gauge.
- 3 | **Note:** the exposure or contact of the apparatus to organic solvents or vapours or other aggressive chemicals must be totally avoided. The instrument is non-autoclavable.

Code	Description
QLB006	Bell jar with hand vacuum pump

U-tube manometer



- 1 | Glass manometer U-shaped tube with stopcock near the end of one of the arms and mounted on a stand.
- 2 | The scale presents a graduation 50-0-50 cm with divisions of 1 mm.

Code	Description
QLB007	U-tube manometer

Magdeburg hemispheres



- 1 | The instrument consists of two plastic hemispheres of about 100 mm diameter, both with a handle at their top.
- 2 | One of them presents a plastic stopcock for pumping out air and releasing vacuum and a rubber O-ring seal inside.

Code	Description
QLB008	Magdeburg hemispheres



QLD - Waves and sound



Wave form helix



- 1 | Steel wire helixes specially designed for demonstration of wave motion.
- 2 | The Snakey helix presents looped ends for safety.

Code	Description	∅	Longitud
QLD001	Snakey	19 mm	3 m
QLD002	Slinky	75 mm	10 cm

▶ QLD - Waves and sound

▶ Vibrator generator with accessories

- 1| Specially indicated to produce mechanical oscillations.
- 2| The voltage input is via a pair of 4 mm banana sockets and mechanical oscillation output is obtained through a shaft at the top.
- 3| A locking device confers safety by blocking the movement of the shaft.
- 4| The equipment is supplied complete with Chladni plates and steel strips.

Code	Description
QLD003	Vibrator generator with accessories

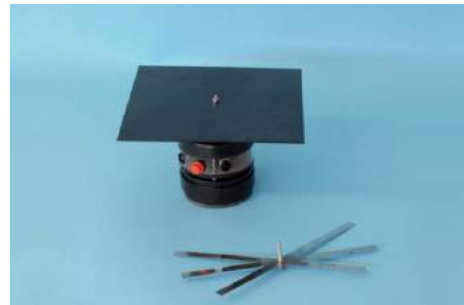

▶ Melde's apparatus

- 1| To show the effects of the vibrations in a stretched cord and investigate the relationship between frequency, tension and density. Composed of a thin steel rod mounted on a clamp formed by a pair of 4 mm terminal sockets, so that its free length can be adjusted as desired.

Code	Description
QLD004	Melde's apparatus



▶ Pendulum

- 1| The instrument consists of a meter rule with 0 at the bottom, graduated in millimetres and with readings every centimetre that is attached vertically on a support rod.
- 2| At the upper end of the support rod a hanger is fixed, from which 3 pendulum bobs, each of 25 mm diameter and of different material (wood, steel and aluminium) are suspended. The suspension length of each pendulum can be controlled.

Code	Description
QLD005	Pendulum



▶ Pair of tuning forks with box

- 1| It comprises two matched nickel plated tuning forks of frequency A (426.6), each one of them mounted on top of hollow wooden box open at one end.
- 2| Both forks present a sliding mass on one prong by means of which its frequency can be varied from the nominal 426.6 Hz.
- 3| The instrument also includes a disk-shaped rubber mounted hammer.

Code	Description
QLD006	Pair of tuning forks with box





QLD - Waves and sound



▶ Set of 8 tuning forks, steel

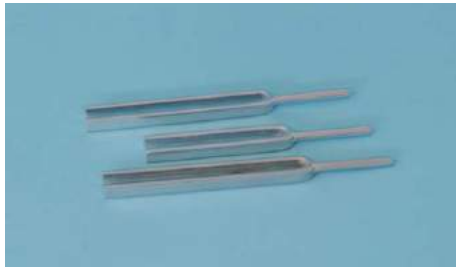

- 1| With the best quality, plain shanks and with frequency clearly marked.
- 2| Each set is composed of 8 forks, one each of diatonic scale frequencies: C1-(256), D-(288), E-(320), F-(341.3), G-(384), A-(426.6), B-(480) y C2-(512).
- 3| The complete set is supplied in a box.

Code	Description
QLD007	Set of 8 tuning forks, steel



QLG - Light and optics



▶ Newton colour disks



- 1| They consist of a multi-coloured circular disk having sectors of various spectral colours in proper proportions.
- 2| By rotating the disk at sufficient speed, all the colours will be observed to disappear by merging into a single white colour.

Code	Diameter	Type
QLQLG001	200 mm	Manual (Handle at the back)
QLG002	80 mm	Motorized (Low DC voltage motor)

▶ Light box and optical set



- 1| A complete kit providing comprehensive range of optical experiments involving reflection, refraction and colour mixing.
- 2| The complete set includes: set of 5 acrylic prisms, set of 3 acrylic lenses, set of 3 mirrors, set of 2 plates, set of 8 colour filters, set of 8 colour plates.

Code	Description
QLG003	Light box and optical set

▶ Optical bench



- 1| An optical bench made of cross sectional aluminium pipe with closed ends, fitted on two moulded supports with levelling screws.
- 2| The optical bench is supplied complete with the following accessories: halogen lamp, plane glass, lens holder, black circular screen with aperture, diaphragm, ground glass screen, grating holder, plate with cross slits, Jolly's photometer, support with needles, receiver screen

Code	Description
QLG004	Optical bench complete with accessories

▶ QLG - Light and optics

▶ Complete Hartl disk

- 1 | It is composed of a rotatable white metal disk, of around 30 cm diameter.
- 2 | The disk presents a graduation of 90° - 0 - 90° - 0 - 90° (divisions of 1°) that divides the disk in 4 equal quadrants with its centre clearly marked.
- 3 | The apparatus is supplied with a laser type light source that allows the projection of 1, 3 or 5 parallel beams for performing different experiments. A complete set of optical elements is also included: Acrylic prisms and mirrors (reflection): plane and semi-circular

Code	Description
QLG005	Disco de Hartl completo



▶ Refraction disk

- 1 | A metallic circular disk graduated (0 - 90°) in 4 quadrants and subdivided into 1° .
- 2 | All this assembly is fitted on a metallic base which is graduated from 1-7 to place the light box at any desired level.

Code	Description
QLG006	Refraction disk

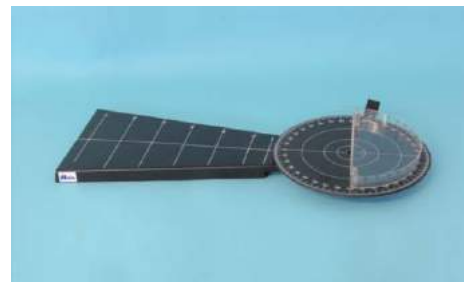

▶ Laser ray box, red

- 1 | Laser ray box of red colour (wavelength 650 nm) with the option of 1, 3 or 5 parallel beams. It is supplied complete with power adapter.

Code	Description
QLG007	Laser ray box, red



▶ Hand spectroscope

- 1 | It presents the main components as collimator, prism and telescope mounted inside an straight tube; one of the ends of the tube presents an adjustable slit to regulate the light entering inside and the other end is provided with an eyepiece.
- 2 | Supplied complete in a wooden box.

Code	Description
QLG008	Hand spectroscope



▶ Power supply for spectral tubes

- 1 | It presents a sturdy and durable case made of metal and allows placing the tubes vertically.
- 2 | With On/Off switch and shielded sockets for safety during use.

Code	Power supply
QLG009	220-240 V AC, 50 Hz



▶ QLG - Light and optics



▶ Spectral tubes

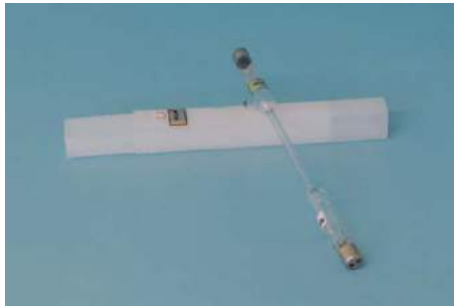

- 1 | With straight shape and about 20 cm long, each tube is filled with a type of gas or vapour.
- 2 | The metal cap electrodes at both ends serve as connection to the high voltage power supply.

Code	Type of gas	Length
QLG010	Argon	200 mm
QLG011	Helium	200 mm
QLG012	Neon	200 mm
QLG013	Hydrogen	200 mm
QLG014	Nitrogen	200 mm
QLG015	Mercury	200 mm

▶ QLJ - Thermology



▶ Gravesande's ring and ball



- 1 | It is composed of a brass ring and ball each one of them mounted on separate insulated handles.
- 2 | When cold, the ball of 19 mm diameter.

Code	Description
QLJ001	Gravesande's ring and ball

▶ Joule's calorimeter



- 1 | It is composed of an inner vessel of about 300 mL of capacity contained inside and outer vessel of about 900 mL both of them made of aluminium and separated by an isolating material that minimizes heat loss.
- 2 | The lid is also provided with stirrer and a hole to put a thermometer (thermometer is not included).

Code	Description
QLJ003	Joule's calorimeter

▶ Thermal conductivity apparatus star shaped



- 1 | For demonstration of differences in the thermal conductivity of five different metals: brass, copper, aluminium, mild steel and stainless steel.
- 2 | The 5 metal rods spread radially outwards and are equally spaced on each side of hexagonal brass hub.
- 3 | The instrument is completed with an isolating handle.

Code	Description
QLJ002	Thermal conductivity apparatus star shaped

▶ QLJ - Thermology

▶ Calorimeter block

1| Each block is cylindrical shaped, has a mass of $1 \text{ Kg} \pm 2\%$ and presents 2 holes, a large central hole (about 12.5 mm diameter) to accept special immersion heater and a smaller hole (about 7.5 mm diameter) to accept a thermometer or temperature sensor.

Code	Material
QLJ004	Aluminium
QLJ005	Steel
QLJ006	Copper
QLJ007	Brass



▶ Heating resistance for calorimeter blocks

1| It is a especial heater designed for use with metal block calorimeters.
2| The heating element is enclosed in a stainless steel tube with two flying leads coming out of the sealed tube body for electrical connections

Code	Description
QLJ008	Heating resistance for calorimeter blocks



▶ Boyle's law apparatus

1| This device allows studying the relationship pressure/volume of a gas at constant temperature.
2| It consists of a graduated cylinder of (0-300) cm^3 , made of transparent material and mounted on a support. One of the ends of the cylinder is closed by a piston and the other end presents a valve to adjust the mass of air contained inside the cylinder..
3| The reading of the pressure inside the cylinder is made by a pressure gauge placed near the valve and graduated from $(0-3.4) \times 10^5 \text{ Pa}$.

Code	Description
QLJ009	Boyle's law apparatus



▶ Gas kinetics theory model

1| It is composed of a clear cylindrical tube closed at the top through a loose-fitting lid and with a rubber diaphragm at the base. The instrument also includes a set of small metal spheres and a cardboard disk for loading at the top.

Code	Description
QLJ010	Gas kinetics theory model



▶ QLL - Magnetism and electrostatics



▶ Magnets



Code	Shape	Dimensions	Material
QLL001	Rectangular	75x15x10 mm	Alnico
QLL002	Cylindrical	100x12 mm	Alnico
QLL003	Ring	36x18x8 mm	Ceramics
QLL004	Horeshoe	75x12x5 mm	Chromed steel

▶ Iron filling, fine



1 | For the study of magnetic fields. Supplied in box of 500 g.

Code	Description
QLL005	Iron filling, fine

▶ Magnetic field demonstrator, 3D

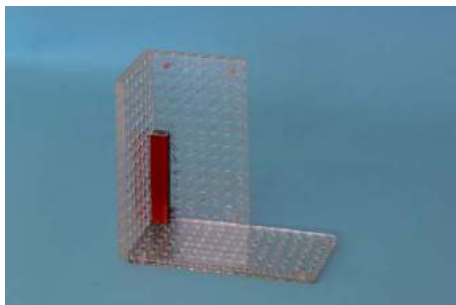

1 | Set of 4 transparent plate with size 155x76x6 mm that present a matrix of small circular chambers (14x7 mm) each one containing an iron rod and that act as small compasses.

2 | The transparent nature of the plates makes them suitable to be used with a projector

3 | The set also includes a rectangular magnet.

Code	Description
QLL006	Magnetic field demonstrator, 3D

▶ Magnetic field chamber



1 | Composed of an empty chamber made of transparent acrylic material with a hole in its central part to enclose the cylindrical magnet.

2 | It also allows studying magnets of other shapes by simply placing adjacent poles at any side of the chamber.

Code	Description
QLL007	Magnetic field chamber

▶ Stand with magnetic needle



1 | Stable circular base of bakelite with non-magnetic pillar and carbon steel pivoting point for the needle. Total height of about 110 mm.

Code	Description
QLL011	Stand with magnetic needle

▶ QLL - Magnetism and electrostatics

▶ Magnetic field demonstrators

1| . For the study and demonstration of magnetic fields associated to different shapes of an electric current conductive wire. 3 models available:

1. Straight: U-shaped copper wire vertically mounted on the base. Maximum current of 8 A.
2. Circular coil: 1-coil copper wire. Maximum current of 8 A.
3. Solenoid: copper solenoid of about 52x125 mm (diam. x length).

Code	Shape
QLL008	Straight
QLL009	Coil
QLL010	Solenoid

REF. QLL010

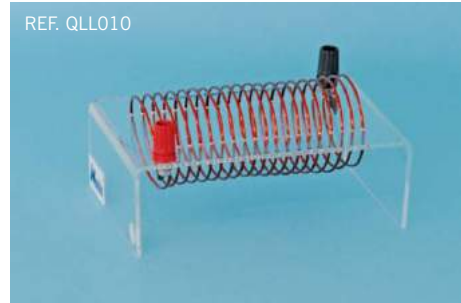

▶ Compass inclinometer

- 1| To demonstrate the earth magnetic field and illustrate the general rule.
- 2| It consists of an aluminium ring with a double pointed needle pivoting in the centre; the ring is graduated from 0-360° in both clockwise and anticlockwise directions.
- 3| The whole assembly is fitted on an aluminium pillar and mounted on a plastic base of approx. 142x80x40 mm .

Code	Description
QLL012	Compass inclinometer



▶ Laplace's rail

- 1| It consists of an acrylic base from which 2 parallel brass bars of about 120 mm length come out .
- 2| To demonstrate the action of a magnetic field on a free moving conductive element placed on two conductive elements.

Code	Description
QLL013	Laplace 's rail

▶ Van de Graaf generator

- 1| The aluminium base presents isolated sides made of plastic for a higher safety.
- 2| The motor operates on AC power supply 220-240 V, 50/60 Hz and is activated through an On/Off switch.
- 3| The equipment presents a socket for 4 mm banana plug at the base for earth connection and another socket at the top for charge transfer or for attaching accessories.
- 4| It is supplied complete with accessories and a discharge sphere with isolating handle.

Code	Description
QLL014	Van de Graaff generator

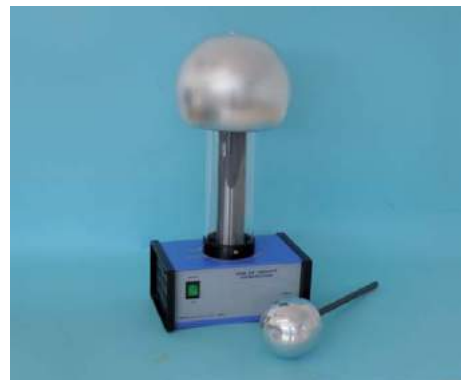

▶ QLL - Magnetism and electrostatics



▶ Wimshurst electrostatic generator



1 | It is equipped with 2 acrylic parallel plates that rotate in opposite directions through a system of pulleys and belts. The device has also 2 crossed rods with collecting "combs" at their end and 2 discharge spheres. The charge can be accumulated in a couple of high capacity Leyden jars.

2 | When the machine starts rotating, the spheres start accumulating charge until the charge transfer between both spheres takes place in the form of an electric spark. The spark is produced intermittently by the continuous rotation of plates.

3 | The complete machine is mounted on a well-isolated base that has also a couple of sockets for earth connection of the Leyden jars.

Code	Description
QLL015	Wimshurst electrostatic generator

▶ QLN - Electricity and electronics



▶ Power supply 1-12 V AC/DC



1 | The equipment is provided with overloading and short circuit protection.

Code	QLN001
Power supply	220-240 V AC, 50 Hz
Output voltage	AC/DC 1-12 V
Intensity	6 A máx.
Primary protection	Fuse 2 A
Secondary protection	Thermal switch

▶ Regulated power supply 1-15 V DC



Code	QLN002
Power supply	110-220 V \pm 10% AC, 50/60 Hz
Output voltage	0-15 V DC, continuous variable range
Intensity	0-2 A max., continuous variable range
Displays	2 LED displays for voltage and intensity
Environmental cond. of use	0-40°C, 95% HR

▶ Electric field apparatus

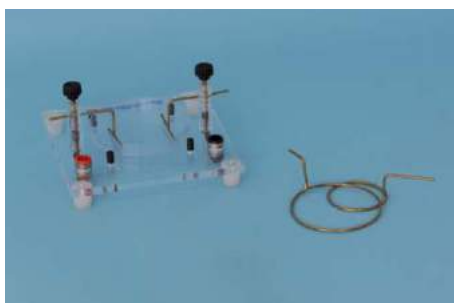

1 | Rectangular transparent base provided with 2 sockets for 4 mm banana plugs.

2 | It is supplied complete with a transparent circular plastic plate, 2 lineal electrodes and 2 circular electrodes (35 and 70 mm respectively).

Code	Description
QLN003	Electric field apparatus

▶ QLN - Electricity and electronics

▶ Demonstration dynamo AC/DC

- 1| The whole instrument is mounted on a base and is capable of generating AC and Dc current simultaneously as it is shown by the illumination of a couple of light bulbs placed at the base.
- 2| The equipment consists of an isolated copper wire coil mounted on a support that is placed between two curved metal strips.
- 3| The instrument is completed with a hand operated pulley connect to the coil support through a rubber belt.

Code	Description
QLN004	Demonstration dynamo AC/DC

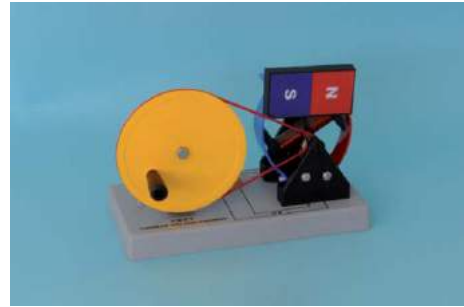

▶ Power cord bananas

- 1| Power cords with 4 mm banana type connectors, available in red and black colour and length of 1 m.

Code	Colour	Length
QLN005	Black	1 m
QLN006	Red	1 m



LABORATORY
SUPPLIERS

SERVICES

TRADEMARKS

STOCK

COMPETITIVITY

AUXILAB
+ROGO
SAMPAIC



ENDO
glassware

Own brand of the group Auxilab/ Rogo Sampaic.
Please know the wide range of laboratory glass
products we offer at your disposal. Glass of quality at a
competitive price to satisfy all your needs

Z - others	Q - didactic material	P - filtration and separation	M - liquid handling	L - stirring	K - measuring instruments	J - heating - cooling	H - optical equipments	G - centrifuges	F - laboratory assemblies and tool	D - volumetry	C - beakers, flasks and other containers	B - general use
------------	-----------------------	-------------------------------	---------------------	--------------	---------------------------	-----------------------	------------------------	-----------------	------------------------------------	---------------	--	-----------------

[R] INDEX OF CONTENTS PROTECTION AND SAFETY

[RB] Protection clothes	292
RBB - Coats.....	292
RBD - Caps	292
RBG - Glasses.....	293
RBJ - Masks	296
RBL - Gloves.....	296
RBN - Shoe covers	297
[RD] Showers and eyewashes	297
RDB - Stations	297
[RZ] Others.....	298
RZB - Table protectors	298

TRADEMARKS:





RBB - Coats



▶ Lab coats, 100% cotton



- 1| Optical white color, snap type buttons (pressure closing), 3 pockets and with collar flap
- 2| Weight 240g/m²

Code	For	Size
RBB001	Man	S
RBB002	Man	M
RBB003	Man	L
RBB004	Man	XL
RBB009	Lady	S
RBB010	Lady	M
RBB011	Lady	L
RBB012	Lady	XL

▶ Lab coats, mixture



- 1| 65% polyester-35% cotton
- 2| Optical white colour, snap type buttons (pressure closing), 3 pockets and collar flap
- 3| Weight 240g/m²

Code	For	Size
RBB005	Man	S
RBB006	Man	M
RBB007	Man	L
RBB008	Man	XL
RBB013	Lady	S
RBB014	Lady	M
RBB015	Lady	L
RBB016	Lady	XL

▶ Lab coats, disposable



- 1| Unisex, synthetic material (non-woven material)
- 2| Snap type buttons (pressure closing), elastic cuff and collar flap

Code	Colour	Size
RBB017	White	L (165-175 cm)
RBB018	Green	L (165-175 cm)
RBB019	White	XL (176-190 cm)
RBB020	Green	XL (176-190 cm)



RBD - Caps



- 1| Only size, with elastic band. Disposable synthetic material (non-woven material)
- 2| Circular shape, 30 cm diameter
- 3| Supplied in boxes of 100 units

Code	Colour
RBD001	White
RBD002	Green

▶ RBG - Glasses



Antifog



Antifog Plus coating

Fine coat over all the surface of the lens of few μm thick that prevents the formation of condensation water by absorbing the moisture drops. It avoids fog preventing to conduct the job safely.

The Antifogging Plus treatment is permanent



Antiscratch



Antiscratch Plus

Treatment applied on the surface of the lens constituting a barrier against surface damages. Lens are protected from scratches and abrasions caused by the rubbing of solid particles.

The Antiscratch Plus treatment is permanent.

Use areas of application

3

Liquids (drops)

4

Dust with particle thickness $> 5 \mu\text{m}$

5

Gas, vapour, spray, smoke and dust with particle thickness $< 5 \mu\text{m}$

9

Melted metal splashes and penetration of red-hot solids

▶ Safety goggles, series 601

- 1| Panoramic goggle with wide vision field. RX insertion for corrections
- 2| II class IPE (polycarbonate lens). Adjustable elastic headband and soft frame.



Code	RBG001
Frame	Clear-unvented
Use areas	3, 4, 5, 9
Lens	Clear PC



▶ Safety goggles, series 602

- 1| Polycarbonate lens. Indirect ventilation system
- 2| Can be worn over prescription glasses. Adjustable elastic headband and soft frame

Code	RBG002
Frame	Clear
Use areas	3, 4
Lens	Clear UC (without treatment)



▶ Safety eyewear model 503, can be sterilized

- 1| Adjustable length of temples. Version without treatment (UC) that can be sterilized
2. Built-in lateral protections

g = 29 g

Code	RBG003
Frame	Clear
Lens	Clear UC



g = 29 g 

Code	RBG004
Frame	Light blue
Lens	Clear





RBG - Glasses



▶ Safety eyewear series 505



- 1| Neck cord included in the packaging
- 2| Extremely light and wraparound, anti-slip soft rubber nose pad
- 3| Elastic structure, very flexible and resistant. Increased UV protection (UV400)

g = 22 g

Code	RBG005
Frame	Clear
Lens	Clear



g = 22 g

Code	RBG006
Frame	Clear
Lens	Clear

▶ Safety eyewear model 511, small faces



- 1| Temples adjustable in length and inclination
- 2| Certified small faces version, with H marking according to EN166 standards
- 3| Frame made of anti-allergic material, built-in lateral protection

g = 34 g

Code	RBG007
Frame	Blue
Lens	Clear

▶ Safety eyewear series 511



- 1| Temples adjustable in length and inclination
- 2| Frame made of anti-allergic material, built-in lateral protection

g = 34 g

Code	RBG008
Frame	Black
Lens	Clear



g = 34 g

Code	RBG009
Frame	Blue
Lens	Clear

▶ Safety eyewear series 520



- 1| Ventilation system on lateral protections
- 2| Can be worn over prescription glasses. Version without UC treatment that can be sterilized

g = 43 g

Code	RBG012
Frame	Clear
Lens	Clear UC

RBG - Glasses



▶ Safety eyewear series 519

- 1 | Ventilation system on the lateral protections
- 2 | Temples adjustable in length and inclination. Can be worn over prescription glasses



Code	RBG010
Frame	Black - grey
Lens	Clear



Code	RBG011
Frame	Black - grey
Lens	Clear

▶ Safety eyewear series 546

- 1 | Wraparound lens with excellent lateral covering
- 2 | Temples that ensure an excellent fit and comfort
- 3 | Non-slip rubber nose band



Code	RBG014
Frame	Black - orange
Lens	Orange



▶ Safety eyewear series 568

- 1 | Economic eyewear ideal for essential protection
- 2 | Light, practical, completely made of polycarbonate.

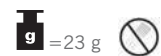

Code	RBG015
Frame	Clear
Lens	Clear



▶ Safety eyewear series 535

- 1 | Large lens without frontal frame, excellent protection of the face and wide vision field
- 2 | Temples adjustable in inclination and length

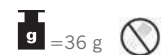

Code	RBG013
Frame	Black - orange
Lens	Clear





RBG - Glasses



▶ Safety eyewear series 5x7



- 1| Can be worn over prescription glasses
- 2| The frame design prevents the overlapping of temples to enjoy absolute comfort
- 3| SoftPad technology. Length adjustment of temples



Code	RBG016
Frame	White - blue
Lens	Clear

▶ Face shield series 699 with frame



- 1| Interchangeable frontal foam sweat band. Upper band for height adjustment of the shield
- 2| Upper adjustment through an elastic band. 1mm thick 90° folding polycarbonate shield
- 3| Can be used over protection eyewear and breathing masks

Code	RBG017
Use area	3



RBJ - Masks



- 1| Only size, 17.50x9.50 cm (wide x high), with elastic bands
- 2| 2 polypropylene layers+filter and built-in nasal pad. Disposable synthetic non-woven material
- 3| Supplied in boxes of 50 units.

Code	Colour
RBJ001	White
RBJ002	Green



RBL - Gloves

▶ Silicone rubber semi-glove



- 1| Of silicone. Raised inner surface to ensure optimal grabbing

Code	Temperature max..	Size
RBL002	140 °C	Only

RBL - Gloves

► Of cotton

1| Cotton thickness: 850 g/m². For short length handlings

Code	Temperature max..	Size
RBL003	100 °C	Only



RBN - Shoe covers



- 1| Only size, 40x17 cm (wide x high)
- 2| Supplied in boxes of 100 units.

Code	Colour
RBN001	White
RBN002	Green



RDB - Stations

► Emergency eyewasher



- 1| Pedestal type and base anchored to ground. Automatic opening and closing valve
- 2| With two big flow sprays of water aired at low pressure

Code	Material
RDB005	Stainless steel
RDB006	Anticorrosion plastic tank PVC coated steel pipe



► Emergency shower



- 1| Big diameter shower head, triggered by a rigid handle
- 2| With pedestal type eyewasher, with two big flow sprays of water aired at low pressure and manual lateral opening



Code	Material
RDB004	Stainless steel 304

▶ RZB - Table protectors

▶ Protection paper



- 1 | To protect working surfaces and the user in case of aggressive liquid spills
- 2 | Weight: 140 g/m², thickness: 250 μm.

Code	Dimensions	N° sheets
RZB013	460x570 mm	50

R - protection and safety	Q - didactic material	P - filtration and separation	M - liquid handling	L - stirring	K - measuring instruments	J - heating - Cooling	H - optical equipments	G - centrifuges	F - laboratory assemblies and tools	D - volumetry	C - beakers, flasks and other containers	B - general use
												

[Z] INDEX OF CONTENTS OTHERS

[ZC] Cleaning and sterilization	298
ZCC - Ultrasound baths.....	298
ZCF - Brushes	299
ZCH - Paper.....	300
ZCZ - Others	301
[ZF] Autoclaves, accessories	301
ZFD - Molecular biology	301
ZFP - Histology	304
ZFR - Histology, accessories.....	307
[ZH] Sample preparation	308
ZHB - Paddle blenders	308
ZHD - Paddle blenders, accessories	308
[ZK] Water, food analysis.....	309
ZKN - Productos lácteos.....	309
ZKZ - Others	310
[ZM] Items for clinical use.....	310
ZMB - Blood analysis.....	311
ZMD - Urine containers	311

trademarks:



▶ ZCC - Ultrasound baths

▶ Digital without heating



- 1 | Made of ABS plastic with an oval shaped tank med of AISI 304 (EN 1.4301) stainless steel.
- 2 | High frequency generators with overload protection.
- 3 | Supplied with plastic lid (for phonic isolation) and basket (for protection of the instruments to be cleaned and the tank).
- 4 | Timer from 1-7 min
- 5 | IP20 protection grade

Code	ZCC012
Tank volume	0.6 L
Ultrasound power	50 W
Generator	1 x 50 W
Drain tap	No
External dim. (LxAxH) (mm)	193x120x123
Inner tank dimensions (LxAxH) (mm)	160x90x50
Basket dimensions (LxAxH) (mm)	140x70x40
Power	220-240 V; 50-60 Hz

▶ Digital with heating



- 1 | Tank and case made of AISI 304 (EN 1.4301) stainless steel.
- 2 | Supplied with lid (for phonic isolation) and basket (for protection of the instruments to be cleaned and the tank).
- 3 | Timer from 1-60 min and also continuous operation
- 4 | With degas and sweep functions. With drain tap for emptying the tank

Code	ZCC005	ZCC006	ZCC007
Tank volume	3 L	6 L	13 L
Ultrasound power	160 W	240 W	400 W
Generators	2x80 W	3x80 W	5x80 W
Potencia calefacción	120 W	120 W	200 W
Rango temperatura	RT+5°C – 80°C		
Drain tap	Yes	Yes	Yes
Dim. ext. (LxAxH) (mm)	265x165x225	330x175x290	330x270x355
Inner tank dim. (LxAxH) (mm)	238x138x100	302x152x150	302x239x200
Basket dimensions* (mm)	220x120x60	285x140x135	280x225x180
Power	220-240 V; 50-60 Hz		

* (LxAxH)

▶ Analógicos con calefacción



- 1 | Tank and case made of AISI 304 (EN 1.4301) stainless steel.
- 2 | Supplied with lid (for phonic isolation) and basket (for protection of the instruments to be cleaned and the tank)
- 3 | Timer from 1-60 min and also continuous operation
- 4 | With drain tap for emptying the tank (except ref. ZCC008)

Code	ZCC008	ZCC009	ZCC010	ZCC011
Tank volume	0.8 L	3 L	6 L	12 L
Potencia ultrason.	60 W	120 W	180 W	300 W
Generators	1x60 W	2x60 W	3x60 W	5x60 W
Heating power	140 W	120 W	120 W	200 W
Temp. range.	RT+5°C – 80°C			
Drain tap	No	Yes	Yes	Yes
External dim.*	200x110x160	265x165x225	330x175x290	600x65x355
inner tank dim.*	180x90x50	238x138x100	302x152x150	500x135x150
Basket dimensions* 170x75x40	220x120x60	285x140x135	480x120x135	
Power	220-240 V; 50-60 Hz			

* (LxAxH) (mm)

ZCC - Ultrasound baths

Detergent for ultrasonic baths



- 1 | Formulated to eliminate general dirt and chemical residues from glass and laboratory instruments
- 2 | Biodegradable, without phosphates and concentrated, to mix 20 mL per liter of water

Code	Capacity
ZCC004	1 L container



ZCF - Brushes

Mousse range



- 1 | Autoclavables.
- 2 | Model n°1 made from fibres.
- 3 | Models n° 2, 3 and 4 made from polyethylene foam that is durable and long lasting

Code	N°	Total length	Application
ZCF001	3	480 mm	Measuring cylinders...
ZCF002	2	250 mm	Beakers, flasks, jars...
ZCF003	1	220 mm	Test tubes Ø < 25mm
ZCF004	4	440 mm	Test tubes, Erlenmeyer flasks...



Flexible brushes



- 1 | Flexible rubber hose covered with a sheath of polyvinyl chloride.

Code	Ø bristle	Bristle length	Total length
ZCF005	30 mm	165 mm	580 mm
ZCF006	45 mm	200 mm	720 mm



With tuft



- 1 | Made of zinc-plated steel wire and natural bristle. With ring to be hung at the end of the handle.

Code	Length	Brush (ØxL)	For
ZCF008	360 mm	15x70 mm	Small tubes
ZCF009	350 mm	25x75 mm	Medium tubes
ZCF010	350 mm	30x85 mm	Large tubes
ZCF015	850 mm	10x180 mm	Burettes 10 mL
ZCF016	870 mm	15x260 mm	Burettes 25 mL



Without tuft



- 1 | Made of zinc-plated steel wire and natural bristle. With ring to be hung at the end of the handle.

Code	Length	Brush (ØxL)	For
ZCF007	300 mm	10x70 mm	Hemolysis tubes
ZCF011	380 mm	40x110 mm	Probetas 250 mL
ZCF012	380 mm	50x130 mm	Cylinders 500 mL
ZCF013	440 mm	56x140 mm	Cylinders 1 L
ZCF014	440 mm	80x160 mm	Cylinders, 2 L
ZCF018	500 mm	10x100 mm	Pipettes
ZCF017	450 mm	80x150 mm	Glasses
ZCF019	210 mm	15x70 mm	Tracheal
ZCF020	270 mm	5/10x80 mm	Butyrometers



ZCZ - Others

▶ Draining rack 20 places



1 | Made of polypropylene (PP). Wall model. 20 pins detachables

Code	Dimensions
ZCZ003	500x350x100 mm

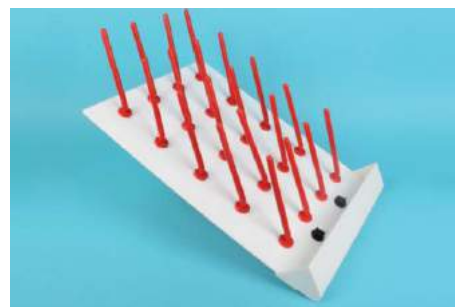

▶ Draining rack, desktop or hanged



1 | Made of plastic coated steel.
2 | Lower shelf for dripping water

Code	Hangers	HxLxA (mm)
ZCZ001	32	470x360x160mm
ZCZ002	55	640x360x140mm



ZFD - Molecular biology



▶ Thermalcycler PureAmp G

1 | High quality and durability of Peltier technology components which increase the working life of the equipment
2 | Gradient function to facilitate the set-up of the technique.
3 | High-performance universal power supply
4 | Large 5.7 inch high definition LCD display. Graphical interface.
5 | Power-down data protection. Heated and adjustable lid
6 | Resistant metal shell, solid and durable

Code	ZFD012
Capacity	96x0.2 mL
Temperature range	0 – 99.9°C
Heating rate	4°C/s
Cooling rate	3°C/s
Uniformity	≤±0.3°C
Accuracy	≤±0.2°C
Screen resolution	0.1°C
Temperature contro	Block / Tube
Tasa de incremento de temp.	0.1 - 4°C/s
Uniformity de gradiente	≤±0.3°C
Accuracy de gradiente	≤±0.2°C
Gradient temperature range	30-99.9°C
Gradient extension	1-30°C
Hot lid range	30 - 110°C
Adjustable lid	Yes
Number of programs	200
Max. number of segments	9
Max. number of steps	9
Max. number of cycles	99
Time increase/decrease	1 second – 9 min 59 s
Temperature increase/decrease	0.1 – 9.9°C
Pause function	Yes
Auto data protection	Yes
Graphical display	Yes
Hold low temperature at 4°C	Indefinite time
LCD display	5.7", 320x240 pixels
Port	RS232
Dimensios (LxAxH)	392x262x252 mm
Weight	10 Kg
Power	85-260 V AC, 50-60 Hz, 600 W



 ZFD - Molecular biology

 Thermalcyclers, models 4096 and 4196

- 1| High quality and durability of Peltier-based components increasing the life time of the equipment up to 1.000.000 cycles.
- 2| Compact, light and noiseless design for space-saving and easy setup and transportation
- 3| 7" Color Touch Screen that allows setting and controlling all functions and that offers information and detailed graphical display of protocols and running status.
- 4| Combi-block to adapt to different type of tubes, strips or plates depending on analysis requirements.
- 5| Heated and height adjustable lid .
- 6| USB and LAN communication ports for data transferring and possibility of connection of USB flash drive for unlimited storage of protocols
- 7| Gradient function (only model 4196).
- 8| 2 different temperature control modes available: block temperature and tube temperature.
- 9| Multi-user log in..
- 10| Tm calculator: automatically calculates the melting and annealing temperature through input two primer sequences.
- 11| Pause and resume function.

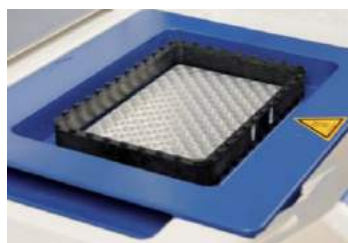

[01]
Detail of 2 in 1
combi-bloc



[02]
Detail of software
application

Code	ZFD001	ZFD002
Modelo	4096	4196
Bloc		
Capacity	96 x 0.2 mL; 77 x 0.5 mL	
Compatibility	Tuboos of 0.2 mL and 0.5 mL (thin-wall) 8 and 12 tube-strips 96 wells PCR plates	
Technology	New generation Peltier-based technology (up to 1.000.000 cycles)	
Display	7" Color Touch Screen	
USB Flash Drive	Unlimited storage of protocols in USB Flash Drive	
Communication ports	2 USB 2.0 y LAN	
Temperature		
Block temperature range	0° C – 100° C	
Max. heating rate	5 °C/s	
Max. cooling rate	4 °C/s	
Temp. uniformity.	≤ ± 0.2 °C (a 95°C)	
Temp. accuracy	≤ ± 0.2 °C (35°C – 100°C)	
Temp. control mode.	Tube and bloc	
Adjustable ramping rate	Yes	
Gradient		
Gradient accuracy	-	≤ ± 0.3 °C (35°C – 100 °C)
Column uniformity	-	≤ ± 0.3 °C (at 95°C)
Gradient range	-	30 °C – 99.9 °C
Gradient range	-	1 °C – 30 °C
Lid		
Height	Adjustable lid, accommodates all kinds of PCR tubes, strips and plates	
Temperature range	30°C - 112 °C	
Auto shut-off	Yes	
Software		
Programs	Max. 10.000 programs on board, unlimited storage with USB flash drive	
Max. step & max. cycle	30 steps, 100 typical cycles, max. 60.000 nesting cycles	
Auto pause & Auto restart	Yes	
Hold at 4°C	Yes, for unlimited time	
Power	85 - 265 V ± 25%, 47/63 Hz, Max. 600W	

▶ ZFD - Molecular biology



▶ Horizontal electrophoresis cell

- 1| Bucket made of high quality acrylic material and in one piece to prevent liquid leakage.
- 2| Transparent cover that provides a correct seal to avoid buffer evaporation and electrical leakage; with fixed power cables with banana type connector.
- 3| Easy to replace platinum electrodes.
- 4| The volume of buffer required guarantees not only the refrigeration but also keeps the pH values stable throughout the process.
- 5| Auto-off function when lid is removed

Code	ZFD013
Gel size	78x100 mm
Nº of samples	8/15
Combs size	1 y 2 mm
Buffer (approx.)	300 mL approx.
Input voltaje	150 V
Dimensions (LxAxH)	365x105x55 mm

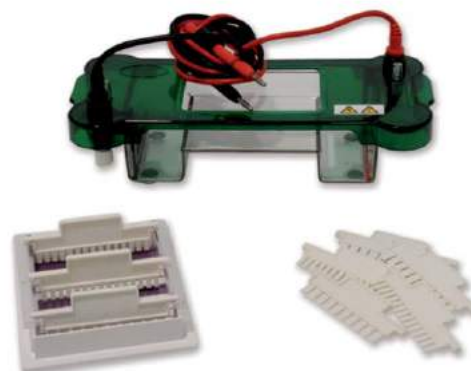

▶ Vertical electrophoresis cell

- 1| For the separation of molecules in polyacrylamide gels
- 2| With platinum electrodes. Compatible with power supply code ZFD014 and the transfer module ZFD006
- 3| It includes:
 - Tank made of acrylic material and in one piece
 - Gel support
 - Gel casting device
 - Glass and notched plates with 1 mm or 1.5 mm thick fixed spacers
 - Combs set of 10 and 15 wells for 1 and 1.5 mm thick gels
 - Thick glass plate in case of conducting electrophoresis of a single gel

Code	ZFD005
Number of gels	1 ó 2
Gel size	82 x 82 mm
Nº of samples	10 ó 15 per gel
Glass plate dimensions	102 x 85 mm
Buffer	750 mL
Electrophoresis time	45-60 min (a 200 V)
Tank dimensions (LxAxH)	150x140x100 mm
Weight	0.9 Kg



▶ Transfer module

- 1| For protein transference from polyacrylamide gels (Western Blot)
- 2| Support with platinum electrodes
- 3| With colour code to ensure the correct orientation of the gel during the transferring process
- 4| Compatible with external tank of the vertical electrophoresis cell and supply source code ZFD014
- 5| It includes:
 - 2 polycarbonate cassettes with pore plates
 - 4 pads

Code	ZFD006
Pore plate dimensions	95 x 87 mm
Buffer	500 mL
Working conditions	0-40°C; ≤80% HR



▶ ZFD - Molecular biology



▶ UV transilluminator



- 1 | UV illumination source wavelength 312 nm
- 2 | Equipped with 4 quartz lamps of 8 W.
- 3 | Screen highly transparent and protective against UV emission. It can be positioned at any angle for safe and comfortable use of equipment.

Code	ZFD015
Wavelength	312 nm
Filter size, UV	150x200 mm
Emission power	4 x 8 W
Dimensions (LxAxH)	325x265x150 mm
Power	220 V; 50 Hz

▶ Power supply for electrophoresis



- 1 | Easy to use the LCD display and control panel.
- 2 | Programed value and actual value are indicated at the same time. Programmable time function.
- 3 | With automatic detection of lack of load, overload, short circuit, rapid change of resistance and system overheating.

Code	ZFD014
Output voltaje	10-300 V
Output current	1-400 mA
Output power	1-120 W
Outputs	4 parallel outputs
Dimensions (LxAxH)	230x237x118 mm
Power	220 V; 50 Hz

▶ ZFP - Histology



▶ Hand microtome, model 501



- 1 | With glass stage and inner clip to fasten de inclusion.
- 2 | Micrometric screw in the base to move the sample up.
- 3 | Slice range from 10 μ m.
- 4 | Fix folding knife included.

Code	ZFP001
Diameter	65-66 mm

▶ Microtomo de rotación manual, básico



- 1 | Light to turn handwheel, it presents a locking device locks in the inner mechanism.
- 2 | Micrometric screw in the base for advancing the sample.
- 3 | Clip for samples with orientation system
- 4 | The equipment is supplied with a 12 cm-long knife; it is also compatible with blade holder for disposable blades ref. ZFR008 (not included).
- 5 | The blade carrier can be moved front and backwards and also laterally.

Code	ZFP010
Section thickness	1-25 μ m
Min. adjustment	1 μ m
Accuracy	\pm 10%
Max. specimen size	25x35 mm
Blade orientation angle	0-10°
Horizontal sample stroke	35 mm
Vertical sample stroke	46 mm
Dimensions (LxWxH)	350x350x270 mm
Weight	26 Kg

ZFP - Histology



Manual rotary microtome, advanced

- 1 | Robust and easy to clean design.
- 2 | Manual handwheel: the equipment presents a light to turn handwheel with ergonomic handle that minimizes fatigue after long periods of use.
- 3 | Coarse feed wheel with a lower position for an easy access.
- 4 | The blade carrier can be also moved front and backwards and presents a regulation system of the cutting edge angle.
- 5 | The microtome is supplied with both standard and universal clamp for embedding cassettes.

Code	ZFP011
Section thickness	0.5-60 μm
Section thickness setting	From 0.5-2 μm in steps of 0.5 μm From 2-10 μm in steps of 1 μm From 10-20 μm in steps of 2 μm From 20-60 μm in steps of 5 μm
Accuracy	$\pm 5\%$
Max. specimen size	50x45 mm
Blade orientation angle	0-12°
Coarse feed	Manual
Horizontal sample stroke	35 mm
Vertical sample stroke	46 mm
Sample orientation	8° (axis X-Y); rotatable 360°
Dimensions (LxAxH)	300x570x270 mm
Weight	34 Kg



Rotary microtome semi-automatic

- 1 | Robust, comfortable and easy to clean design.
- 2 | Safety for user, with Blade holder for disposable blades with finger safety guard to protect user during work breaks and locking system by means of a lever placed at the lateral base of equipment that locks handwheel at any position.
- 3 | Touch screen for parameter set and control: motorized feeding of the sample, section thickness, trimming section thickness and slice counting.
- 4 | Manual handwheel with ergonomic handle.
- 5 | The blade carrier presents a lateral adjustment mechanism.
- 6 | The microtome is supplied with standard and universal clamp. The microtome can be also used with a special clamp for slicing plastic layers (not included).

Code	ZFP012
Section thickness range	0.5-100 μm
Section thickness setting value	From 0.5-2 μm in steps of 0.5 μm From 2-10 μm in steps of 1 μm From 10-20 μm in steps of 2 μm From 20-50 μm in steps of 5 μm From 50-100 μm in steps of 10 μm
Trimming section thickness range	5-500 μm
Trimming section thickness setting value	From 5-100 μm in steps of 10 μm From 100-200 μm in steps of 20 μm From 200-500 μm in steps of 50 μm
Horizontal sample stroke	28 mm, motorized
Vertical sample stroke	60 mm
Sample retraction	12 μm
Accuracy	$\pm 5\%$
Max. specimen size	50x45 mm
Blade orientation angle	0-14°
Sample orientation	8° (axis X-Y); rotatable 360°
Dimensions (LxWxH)	520x450x300 mm
Weight	30 Kg
Power	220 V / 50 Hz





ZFP - Histology



▶ Paraffin dispensing unit



- 1 | Independent temperature adjustment of the different parts: working area, paraffin reservoir, manual/cassettes warmer and dispenser.
- 2 | Large easy to clean granite surface. Dispenser can be activated manually or via foot switch.
- 3 | Dispenser can be activated manually or via foot switch (included).
- 4 | Drainage system with reservoir and easily removable.
- 5 | Heated forceps holder for 6 units.

Code	ZFP006
Temperatura de trabajo	55°C / 70°C (in steps of 5°C)
Capacity	
Depósito parafina	1 x 2 L
Depósitos casetes y moldes	2 x 1 L
Programme operation	Temperature and starting time
Dimensions	390 x 550 x 500 mm
Power	220 V, 50 Hz

▶ Cold plate for paraffin dispensing unit



- 1 | Designed to be used with paraffin dispensing unit during sample embedding and during sectioning with the microtome.
- 2 | Frame around steel surface to prevent dropping around.

Code	ZFP007
Temperature	Up to -20°C
Plate dimensions	31 x 29.8 cm
Total dimensions	57 x 34.5 x 38.5 cm

▶ Histology bath for paraffin sections



- 1 | Black tank for a proper localization of paraffin sections.
- 2 | Wide thermal limit for drying paraffin sections.

Code	ZFP008
Capacity	2 L (aprox.)
Temperature range	Up to 90 °C
Tank dimensions	24x18x5.4 cm
Total dimensions	34x35x10.5 cm

▶ Hot plate for histology



- 1 | For drying microscope slides.

Code	ZFP009
Temperature range	Up to 90 °C
Tank dimensions	34x25cm
Total dimensions	34x25x10.5 cm

▶ ZFR - Accessories

▶ Feather blades





- 1| Made of stainless steel, supplied in cassettes of 50 units..
- 2| Dimensions: 80x8 mm

- Blades not included in microtomes
- Compatible with all models of microtomes
- For basic model, it is necessary to install previously blade holder ref. ZFR008



Code	Mode	Description
ZFR003	R35	For routine purposes
ZFR004	S35	For extrathin sectioning
ZFR001	A35	For hard tissue sectioning
ZFR002	N35	Long duration blades

▶ CHART 1: 'Microtomes accessories'

	Code	Description	Model			
			501	Basic	Advanced	Semi-automatic
	ZFR008	Blade holder for disposable blades Stainless steel; dim. 170x30x10 mm		■		
	ZFR011	Clamp for plastic plate for microtome advanced To slice thin plastic plates as HDPE plates			■	
	ZFR012	Clamp for slicing plastic layers Special clamp for slicing plastic layers in industrial applications				
	FMB001	Histologic folding knife, stainless steel handle	■			■
	FMB002	Histologic folding knife, plastic handle		■		

■ = Accesorio **incluido** con el equipo indicado

■ = Accesorio **compatible** con el equipo indicado



ZHB - Paddle blenders



- 1 | Stainless steel compact design for sample volumes of 50-400 mL.
- 2 | Frontal door with a glass window to allow the control of samples.
- 3 | Tray to collect possible liquid leaks.
- 4 | Digital display that shows the most important parameters.
- 5 | Adjustable homogenization time and speed.
- 6 | Paddle distance and blending strength adjustment mechanism

Code	ZHB001
Timer	10, 30, 60, 90 s; 2, 3, 6 min; modo continuo
Frecuencia de golpeo	6, 7, 8 ó 9 golpes
Potencia	165 W
Dimensions (LxAxH)	22 x 41 x 25 cm
Weight	18 Kg



ZHD - Accessories



CHART 2: 'Paddle blender accessories'

	Code	Description	Model Paddle blenders
	ZHD001	Bags with filter, pack 200 uds	<input type="checkbox"/>
	ZHD002	Standard bags , pack 500 uds	<input type="checkbox"/>
	ZHD003	Rack for blender bags	<input type="checkbox"/>
	ZHD004	Straws for blender bags, pack of 50 uds	<input type="checkbox"/>
	ZHD005	Opener for blender bags	<input type="checkbox"/>

= Accessories **included** with indicated item

= Accessories **compatible** with indicated item

 ZKN - Productos lacteos







 Milk analyzer, Lactoscan SP

- 1| Easy to use, maintain, install and calibrate
- 2| Compact design easily transportable
- 3| Very small milk quantity needed
- 4| Not necessary to use any chemical reagent to make the analysis
- 5| Calibration of measurements can be made through RS232 output
- 6| Printer output ESC POS
- 7| 9 measuring parameters:
 - Fat: 0.01-25% \pm 0.1%
 - Solids-non-fat (SNF): 3-15% \pm 0.15%
 - Density: 1015-1040 Kg/m³ \pm 0.3 Kg/m³
 - Protein: 2-7 % \pm 0.15%
 - Lactose: 0.01-6% \pm 0.2%
 - Added water: 0-70% \pm 3%
 - Temperature: 1-40°C \pm 1°C
 - Freezing point: 0.4-0.7 °C \pm 0.001°C
 - Salts: 0.4-1.5% \pm 0.05%



Code	ZKN001
Temperatura ambiente	10 - 40 °C
Temperatura leche	1 - 40 °C
Humedad relativa	30 - 80%
Power	AC 220V - 110V
Consumption	30 W
Dimensions (LxAxH)	22x41x25 cm
Weight	< 1,5 Kg

 CHART 3: 'LACTOSCAN SP accessories'

	Code	Description	Model LASTOSCAN SP
	ZKN002	Printer for Lactoscan SP analyzer	
	ZKN003	Alkaline cleaning solution, Lactodaily, 1 Kg	
	ZKN004	Acidic cleaning solution, Lactoweekly, 1 Kg	

 = Accessories **included** with indicated item

 = Accessories **compatible** with indicated item

ZKZ - Others



Digester apparatus for trichina



1 | Kit especialmente pensado para llevar a cabo el análisis por medio del método de digestión de muestras colectivas con utilización de un agitador magnético.

Code	Description
ZKZ001	Digester apparatus for trichina

Composed of:

- LBD001 Digital magnetic stirrer w/heating, 692/1
- PQB030 Separating funnel 2L, open, f/trichina apparatus
- PQL006 Cylindrical funnel 50 mL, open, f/trichina apparatus
- ZKZ002 Sieve 100x40, 180 µm
- FCBO05 Retort stand, cast steel, 300x180 mm, rod 10x600mm
- FCV004 Retort ring w/shank closed Ø int. 105 mm, chromeplated steel
- FCV002 Retort ring w/shank closed Ø int. 65 mm, chromeplated steel
- FCG001 Clamp 2 prongs w/o bosshead, 12-45 mm
- FCP002 Double bosshead, painted, medium, 16 mm (3 units)
- CBC025 Beaker low form, 3000 mL
- LDB011 PTFE magnetic stirrer bar, cylindrical, 55x8 mm
- DBG003 Measuring cylinder, glass, 25 ml
- DGJ010 Graduated pipette, 25ml/0.1ml
- MBJ009 Pipette pump, 25 mL red
- LDR010 Policemen stirring rods
- BRB012 Rodac dishes gridded B/20

The equipment is supplied with a standard configuration, although it can be extended with the following element:

- KBC001: Precision balance 300g/0.01g, series 5162
- HDD005: Stereomicroscope ZUZI 234
- FMJ010: Dissecting forceps 1:2 teeth, 160 mm
- FMN011: Straight scissors sharp-sharp, 160 mm
- KKF002: Pocket timer 24 h, 1 memory
- DGJ005: Graduated pipette, 1ml/0.01ml
- DGJ008: Graduated pipette, 10ml/0.1ml

ZMB - Blood analysis

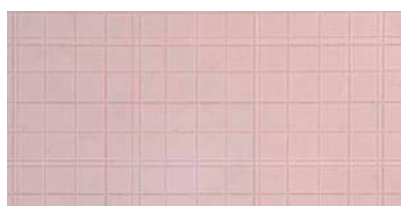

[1] **STANDARD:** the ruling is engraved on the bottom of the chamber and under the microscope it appears as a grid of dark lines.



[2] **WITH CLAMPS:** similar to standard format but in this case the counting chamber is provided with a pair of clamps to hold the cover glass.

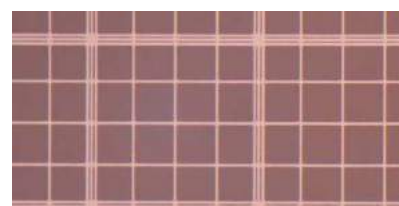

[3] **BRIGHT-LINED:** they present a rhodium-coated bottom that makes the ruling appear as a grid of bright lines under the microscope hus, allowing an optimum contrast.

	Trademark	Standard		With clamps	Bright lines
		Double	Simple	Double	Double
Neubauer Improved	ZUZI	ZMB007			ZMB009
	PRECISS EUROPE (CE)	ZMB027	ZMB030	ZMB028	ZMB029
Bürker	ZUZI	ZMB001			ZMB003
	PRECISS EUROPE (CE)	ZMB013	ZMB016		ZMB015
Fuchs-Rosenthal	ZUZI	ZMB004			ZMB006
	PRECISS EUROPE (CE)	ZMB017	ZMB020	ZMB018	ZMB019
Thoma	ZUZI	ZMB010			ZMB012
	PRECISS EUROPE (CE)	ZMB031	ZMB034	ZMB032	ZMB033
Malassez	ZUZI				
	PRECISS EUROPE (CE)	ZMB021	ZMB024		

ZMB - Blood analysis

Neubauer Improved counting chamber

- 1 | Depth: 0.100 mm
- 2 | Volume 1 mm²: 0.1 μL
- 3 | Area minimum: 0.0025 mm²
- 4 | They are mainly used for counting erythrocytes, thrombocytes and leukocytes.



1 | Without CE (IVD) marked, for sales outside the EC.

Code	Formato
ZMB007	[1] Standard, double net ruling dark-lined
ZMB009	[3] Double net ruling bright-lined



1 | With CE (IVD) marked.

Code	Formato
ZMB027	[1] Standard, double net ruling dark-lined
ZMB028	[2] Double net ruling dark-lined
ZMB029	[3] Double net ruling bright-lined
ZMB030	[1] Simple net ruling dark-lined



Bürker counting chamber

- 1 | Depth: 0.100 mm
- 2 | Volume 1 mm²: 0.1 μL
- 3 | Area minimum: 0.0025 mm²
- 4 | They are mainly used for counting erythrocytes and thrombocytes.



1 | Without CE (IVD) marked, for sales outside the EC.

Code	Formato
ZMB001	[1] Standard, double net ruling dark-lined
ZMB003	[3] Double net ruling bright-lined



1 | With CE (IVD) marked.

Code	Formato
ZMB013	[1] Standard, double net ruling dark-lined
ZMB015	[3] Double net ruling bright-lined
ZMB016	[1] Simple net ruling dark-lined





ZMB - Blood analysis

▶ Fuchs-Rosenthal counting chamber



- 1 | Depth: 0.200 mm
- 2 | Volume 1 mm²: 0.2μL
- 3 | Area minimum: 0.0625 mm²
- 4 | They are mainly used for counting cells in cerebrospinal fluids (CSF).



- 1 | Without CE (IVD) marked, for sales outside the EC.

Code	Format
ZMB004	[1] Standard, double net ruling dark-lined
ZMB006	[3] Double net ruling bright-lined



- 1 | With CE (IVD) marked.

Code	Format
ZMB017	[1] Standard, double net ruling dark-lined
ZMB018	[2] Double net ruling dark-lined, with clamps
ZMB019	[3] Double net ruling bright-lined
ZMB020	[1] Simple net ruling dark-lined

▶ Thoma counting chamber



- 1 | Depth: 0.100 mm
- 2 | Volume 1 mm²: 0.1 μL
- 3 | Area minimum: 0.0025 mm²
- 4 | They are mainly used for counting erythrocytes and thrombocytes.



- 1 | Without CE (IVD) marked, for sales outside the EC.

Code	Format
ZMB010	[1] Standard, double net ruling dark-lined
ZMB012	[3] Double net ruling bright-lined



- 1 | With CE (IVD) marked.

Code	Format
ZMB031	[1] Standard, double net ruling dark-lined
ZMB032	[2] Double net ruling dark-lined, with clamps
ZMB033	[3] Double net ruling bright-lined
ZMB034	[1] Simple net ruling dark-lined

▶ Counting chamber Malassez



- 1 | Depth: 0.200 mm
- 2 | Volume 1 mm²: 0.2 μL
- 3 | Area minimum: 0.0025 mm²
- 4 | They are mainly used for counting blood cells.
- 5 | With CE (IVD) marked

Code	Format
ZMB021	[1] Double net ruling dark-lined
ZMB024	[1] Simple net ruling dark-lined

ZMB - Blood analysis

Coverglasses



- 1| Made of soda glass, with ground edges.
- 2| Thickness 0.4 mm.
- 3| Is supplied in boxes of 10 units.

Code	Dimensions
ZMB036	20x26 cm
ZMB037	22x22 cm
ZMB038	24x24 mm

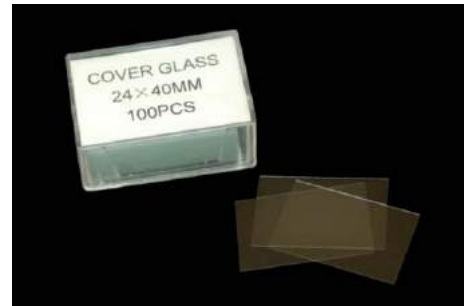

Microhaematocrit capillaries



- 1| Disposable, with easily sealing for a later centrifugation.

Code	Volume	Length	Heparinized	Pack
ZMB047	75 μ L	75 mm	No	Box of 200 uds.
ZMB048*	35 μ L	40 mm	No	Box of 100 uds.
ZMB049*	35 μ L	40 mm	Yes	Box of 100 uds.

* for Fugevet centrifuge



ZMD - Urine containers

Urine Bottles "Sabot" Model Man

- 1| Non graduated.

Code	Volume
ZMD003	900mL



LABORATORY
SUPPLIERS

SERVICES

TRADEMARKS

STOCK

COMPETITIVITY



 **IENDO**
plasticware

Own brand of the group Auxilab/ Rogo Sampaic.
Please know the wide range of laboratory plastic
products we offer at your disposal. Plastic of quality at
a competitive price to satisfy your needs



index
of contents

catalogue
2018 - 2019

B general use	BDL005	9	BJD006	16	BMD121	21	BPD022	24	BTD032	31
	BDL011	9	BJD007	16	BMD122	21	BPD023	24	BTD033	31
	BDL012	9	BJD008	16	BMD123	21	BPD024	24	BTD034	31
	BDL013	10	BJD009	16	BMD124	21	BPD025	24	BTD035	31
	BDL014	10	BJD010	16	BMD125	21	BPG001	25	BTD036	31
	BDL015	10	BJD011	16	BMD126	21	BPG002	25	BTD037	31
	BDL016	10	BJD012	16	BMD127	21	BPG003	25	BTD038	31
	BDL017	10	BJD013	16	BMD128	21	BPG004	25	BTD039	31
	BGB001	10	BJD014	16	BMD129	21	BPG005	25	BTD040	31
	BGB002	10	BJD015	16	BMD130	21	BPG006	25	BTD041	31
BGB003	10	BJD016	16	BMH103	21	BPG007	25	BTD042	31	
BGB005	10	BJD017	16	BMH104	21	BPG008	25	BTD043	31	
BGB006	10	BJD018	16	BMH105	21	BPG009	25	BTD044	31	
BGB007	10	BJD019	16	BMH106	21	BPG010	25	BTD045	31	
BGB008	10	BJD020	16	BMH107	21	BPG011	25	BTD046	31	
BGB009	10	BJD021	16	BMH108	21	BPG012	25	BTD047	31	
BGB010	10	BJD022	16	BMH109	21	BPG013	25	BTD048	31	
BGB011	10	BJD023	16	BMH110	21	BPG014	25	BTD049	31	
BGB025	10	BJD024	16	BMH111	21	BPG015	26	BTD050	31	
BGB026	10	BJD025	16	BMH112	21	BPG016	26	BTD051	31	
BGB027	10	BJD026	16	BMH113	21	BPG017	26	BTQ001	32	
BGB028	10	BJD027	16	BMH114	21	BPG018	26	BTS001	32	
BGD001	11	BJD028	16	BMH115	21	BPJ001	26	BTS002	32	
BGD002	11	BJD029	16	BMH116	21	BPJ006	26	BTS003	32	
BGD003	11	BJD030	16	BMH117	21	BPJ011	26	BTS004	32	
BGD004	11	BJD031	16	BMH118	21	BPJ016	27	BTS005	32	
BGD006	11	BJD032	16	BMH119	21	BPJ039	27	BTS006	32	
BGD007	11	BJD033	16	BMH120	21	BPJ040	27	BYF001	32	
BGD008	11	BJD034	17	BMH121	21	BPJ041	27	BYF002	32	
BGD009	11	BJD035	17	BMH122	21	BPJ042	27	BYF003	32	
BGD010	11	BJD036	17	BML001	21	BPJ043	27	BYF017	33	
BGD011	11	BJD037	17	BML002	21	BPL001	27	BYF018	33	
BGD070	11	BJJ001	17	BML003	21	BPL003	28	BYF019	33	
BGG001	12	BJJ002	17	BPB001	22	BPL005	28	BYF020	33	
BGG002	12	BJJ003	17	BPB002	22	BPL007	28	BYF024	33	
BGG003	12	BJJ004	17	BPB003	22	BPL008	28	BYF025	33	
BGG004	12	BJJ005	17	BPB004	22	BPL009	28	BYF026	33	
BGG005	12	BJJ006	17	BPB005	22	BPL010	28	BYF027	33	
BGG006	12	BJJ007	17	BPB006	22	BPL012	28	BYF028	33	
BGG007	12	BJJ008	17	BPB007	22	BPL013	28	BYF029	33	
BGG009	12	BJJ009	17	BPB008	22	BPL014	29	BYF030	33	
BGG010	12	BJJ010	17	BPB009	22	BPL015	29	BYF031	33	
BGG011	11	BJJ011	17	BPB010	22	BPL028	28	BYF032	33	
BGJ001	12	BJJ012	17	BPB011	22	BRB001	29	BYF033	33	
BGL022	12	BJJ013	17	BPB012	22	BRB002	29	BYF034	33	
BGL023	12	BJJ014	17	BPB013	22	BRB003	29	BYF035	33	
BGN001	13	BJJ015	17	BPB014	22	BRB004	29	BYF036	33	
BGN002	13	BJJ016	17	BPB015	22	BRB005	29	BYF037	33	
BGN003	13	BJJ017	18	BPB016	23	BRB006	29	BYF038	33	
BGN004	13	BJJ018	18	BPB017	23	BRG009	29	BYF039	33	
BGN005	13	BJJ019	18	BPB018	23	BRG010	29	BYF040	33	
BGN006	13	BJJ020	18	BPB019	23	BRG011	29	BYF041	33	
BGN007	13	BJJ022	18	BPB020	23	BRG012	29	BYF042	33	
BGN025	13	BJJ023	18	BPB021	22	BRG013	29	BYF043	33	
BGV001	13	BJJ024	18	BPB022	22	BRJ001	30	BYF044	33	
BGV002	14	BJJ025	18	BPB023	22	BRJ002	30	BYF045	33	
BGV003	14	BJJ026	18	BPB024	22	BTB013	30	BYF046	33	
BGV010	14	BJJ027	18	BPB025	22	BTB014	30	BYF047	33	
BJB001	15	BJJ028	18	BPB026	22	BTB015	30	BYF048	33	
BJB002	15	BJJ029	18	BPB027	22	BTB016	30	BYF049	33	
BJB003	15	BJJ030	18	BPB028	22	BTB017	30	BYF050	33	
BJB004	15	BJJ031	18	BPB029	22	BTB018	30	BYF051	33	
BJB005	15	BJL001	18	BPB030	22	BTB019	30	BYF052	33	
BJB006	15	BJL002	18	BPB031	22	BTB028	30	BYF053	33	
BJB007	15	BJL003	18	BPB032	22	BTB029	30	BYF054	33	
BJB008	15	BJL004	18	BPB033	23	BTB030	30	BYF055	33	
BJB009	15	BJN008	19	BPB034	23	BD001	31	BYF056	33	
BJB010	15	BJN009	19	BPB035	23	BTD002	31	BYF057	33	
BJB011	15	BJQ001	19	BPB036	23	BTD003	31	BYF058	33	
BJB012	15	BJQ002	19	BPB037	23	BTD005	31	BYF059	33	
BJB013	15	BJQ003	19	BPB038	23	BTD006	31	BYF060	33	
BJB014	15	BJQ004	19	BPB041	23	BTD007	31	BYF061	33	
BJB015	15	BJQ005	19	BPB042	23	BTD008	31	BYF062	33	
BJB016	15	BJQ006	19	BPB043	23	BTD009	31	BYF063	33	
BJB017	15	BJQ007	19	BPB044	23	BTD010	31	BYF064	33	
BJB018	15	BJS005	20	BPB045	22	BTD011	31	BYF065	33	
BJB019	15	BJS006	20	BPD001	24	BTD012	31	BYF066	33	
BJB020	15	BMC001	20	BPD002	24	BTD013	31	BYF067	32	
BJB021	14	BMC002	20	BPD003	24	BTD014	31	BYF068	32	
BJB022	14	BMC003	20	BPD004	24	BTD015	31	BYF069	32	
BJB023	14	BMC004	20	BPD005	24	BTD016	31	BYF070	32	
BJB026	15	BMC005	20	BPD006	24	BTD017	31	BYF071	32	
BJB027	15	BMC006	20	BPD007	24	BTD018	31	BYF072	32	
BJB028	15	BMC007	20	BPD008	24	BTD019	31	BYF073	32	
BJB029	15	BMC008	20	BPD009	24	BTD020	31	BYF074	32	
BJB030	15	BMC009	20	BPD010	24	BTD021	31	BYF075	32	
BJB031	15	BMC010	20	BPD011	24	BTD022	31	BYF076	32	
BJB032	15	BMC011	20	BPD013	24	BTD023	31			
BJB033	15	BMC012	20	BPD014	24	BTD024	31			
BJB034	15	BMC015	20	BPD015	24	BTD025	31			
BJB035	15	BMC016	20	BPD016	24	BTD026	31			
BJD001	16	BMD116	21	BPD017	24	BTD027	31			
BJD002	16	BMD117	21	BPD018	24	BTD028	31			
BJD003	16	BMD118	21	BPD019	24	BTD029	31			
BJD004	16	BMD119	21	BPD020	24	BTD030	31			
BJD005	16	BMD120	21	BPD021	24	BTD031	31			

C
beakers, flasks
and other
containers

CBB001	36
CBB002	36
CBB003	36
CBB004	36
CBB005	36
CBB006	36
CBB007	36
CBB008	36
CBB009	36
CBB010	36
CBB011	36
CBB012	36
CBB013	36
CBB014	36
CBB015	36
CBB016	36
CBB017	36
CBB018	36
CBB019	36
CBB020	36
CBC009	36
CBC010	36
CBC011	36
CBC012	36
CBC013	36
CBC014	36
CBC015	37
CBC016	37
CBC017	37
CBC018	37
CBC019	37
CBC020	37
CBC021	37
CBC022	37
CBC023	37
CBC024	37
CBC025	37
CBC026	37
CBC027	37
CBC028	37
CBC029	37
CBC030	37
CBC031	37
CBC032	37
CBC033	37
CBC034	37
CBC035	37
CBC036	37
CBC037	37
CBC038	37
CBC039	37
CBC040	37
CBC041	37
CBC043	37
CBD001	38
CBD002	38
CBD003	38
CBD004	38
CBD005	38
CBD006	38
CBD007	38
CBH001	38
CBH002	38
CBH003	38
CBH004	38
CBH005	38
CBM001	38
CBM002	38
CBM003	38
CBM004	38
CBN001	39
CBN002	39
CBN003	39
CBN004	39
CBN005	39
CCB001	39
CCB002	39
CCB003	39
CCB004	39
CCB005	39
CCB006	39
CCB007	39
CCB008	39
CCB009	39
CCB010	39
CCL001	39

CCL002	39
CCL003	39
CCL004	39
CDB001	40
CDB002	40
CDB003	40
CDB004	40
CDB005	40
CDB006	40
CDB007	40
CDB008	40
CDB009	40
CDB010	40
CDB011	40
CDB012	40
CDB013	40
CDB014	40
CDB015	40
CDB016	40
CDB017	40
CDB018	40
CDB019	40
CDB020	40
CDB021	40
CDB022	40
CDB023	40
CDB024	40
CDB025	40
CDB026	40
CDB027	40
CDB028	40
CDB029	40
CDB030	41
CDB031	41
CDB032	41
CDB033	41
CDB034	41
CDB035	41
CDB036	41
CDB037	41
CDB038	41
CDB051	40
CDG001	41
CDG002	41
CDG003	41
CDG004	41
CDG005	41
CDG006	41
CDG007	41
CDJ001	41
CDJ002	41
CDJ003	41
CDJ004	41
CDJ005	41
CDJ006	41
CDJ007	41
CFB001	42
CFB002	42
CFB003	42
CFB004	42
CFB005	42
CFB006	42
CFB007	42
CFB008	42
CFB010	42
CFB014	42
CFB015	42
CFB016	42
CFB017	42
CFB018	42
CFB019	42
CFB020	42
CFB021	42
CFB022	42
CFB023	42
CFB024	43
CFB025	43
CFB026	43
CFB027	43
CFB028	43
CFB029	43
CFB030	43
CFB031	43
CFB032	43
CFB033	43
CFB034	43
CFD001	43
CFD002	43
CFD003	43
CFD004	43
CFD005	43
CFD006	43
CFD007	43
CFD008	43
CFD009	43
CFD011	43

CFD012	44
CFD013	44
CFD014	44
CFD015	44
CGB001	44
CGB002	44
CGB003	44
CGB004	44
CGB005	44
CGB006	44
CGD043	45
CGD044	45
CGD045	45
CGD046	45
CGD047	45
CGD048	45
CGD049	45
CGD050	45
CGD051	45
CGD052	44
CGD053	44
CGD054	44
CGD055	44
CGD056	44
CGD057	44
CGD058	44
CGD059	44
CGD060	44
CGD061	44
CGD062	44
CGD063	44
CGD064	44
CGD065	45
CGD066	45
CGD067	45
CGD068	45
CGD069	45
CGD070	45
CGD071	45
CGD072	45
CGD073	45
CGD074	45
CGD075	45
CGD076	45
CGG001	46
CGG002	46
CGG003	46
CGG004	46
CGG005	46
CGG006	46
CGG007	46
CGG008	46
CGG009	46
CGG010	46
CGG011	46
CGG012	46
CGG013	46
CGG014	46
CGG015	46
CGG016	46
CGG017	46
CGG018	46
CGG019	46
CGG020	47
CGG021	47
CGG022	47
CGG023	47
CGG026	47
CGG027	47
CGG028	47
CGG029	47
CGG030	47
CGG031	47
CGG032	47
CGG033	47
CGG053	47
CGG054	47
CGJ033	47
CGJ034	47
CGJ035	47
CGJ036	47
CGJ037	47
CGJ038	47
CGJ039	48
CGJ040	48
CGJ041	48
CGJ042	48
CGJ043	48
CGJ044	48
CGJ045	48
CGJ046	48
CGJ047	48
CGJ048	48
CGJ049	48
CGJ050	48
CGJ051	48

CGJ052	48
CGJ053	48
CGJ054	48
CGJ055	48
CGL001	49
CGL002	49
CGL003	49
CGL004	49
CGL005	49
CGL006	49
CGL007	49
CGL008	49
CGL009	49
CGL010	49
CGL011	49
CGL012	49
CGL013	49
CGL014	49
CGL015	49
CGL019	49
CGL020	50
CGL021	50
CGL022	50
CGN011	50
CGN012	50
CGN013	50
CHB001	50
CHB002	50
CHB003	50
CHB004	50
CHB005	50
CHB006	50
CHB007	50
CHB008	50
CHG001	50
CHG002	50
CHG003	50
CHG004	50
CHG005	50
CHG006	50
CHG007	50
CHG008	50
CKD006	51
CKD007	51
CKD008	51
CKD009	51
CKL004	51
CKL005	51
CKL006	51
CKL007	51
CKL008	51
CKL009	51
CKL010	51
CKL011	51
CLD009	52
CLD010	52
CLD011	52
CLD012	52
CLD013	51
CLD014	51
CLD015	51
CLD016	51
CLD017	52
CLD018	52
CLD019	52
CLG009	52
CLG010	52
CLG011	53
CLG012	53
CLG013	53
CMB001	53
CMB002	53
CMB003	53
CMB004	53
CMB005	53
CMB006	53
CMB007	53
CMB008	53
CMB009	53
CMB010	53
CMB011	53
CMB012	53
CMB013	53
CMD001	53
CML010	54
CML011	54
CNB001	54
CNB002	54
CNB003	54
CNB004	54
CNB005	54
CNB006	54
CNB007	54
CNB008	54
CNB009	54
CNB010	54

CNB011	54
CNB012	54
CNB013	54
CNB014	54
CNB015	54
CNB016	54
CNB017	54
CNB018	54
CNB019	54
CNB020	54
CNG001	54
CNG002	54
CNG003	54
CNG004	54
CNG005	54
CNG006	54
CNG007	54
CNG008	54
CNG009	54
CNG010	54
CNG011	54
CNG012	54
CNG013	54
CNG014	54
CNG015	55
CNG016	55
CNG017	55
CNG018	55
CNG019	55
CNG020	55
CNG021	55
CNG022	55
CNG023	55
CNG024	55
CNG025	55
CNG026	55
CNG027	55
CNG028	55
CNG029	55
CNG030	55
CNG031	55
CNG032	55
CNG033	55
CNG034	55
CNG035	55
CNG036	55
CNG037	55
CNG038	55
CNK001	55
CNK002	55
CNK003	55
CNK004	55
CNK005	55
CNK006	55
CNK007	55
CNK008	55
CNK009	55
CNK010	55
CNK011	55
CNK012	55
CNK013	56
CNK014	56
CNL001	56
CNL002	56
CNL003	56
CNL004	56
CNL005	56
CNL006	56
CNL007	56
CNL008	56
CNL009	56
CNN001	56
CNN002	56
CNN003	56
CNN004	56
CNN005	56
CPB001	57
CPB002	57
CPB004	57
CPB005	57
CPB006	57
CPB007	57
CPB008	57
CPB009	57
CPB010	57
CPB011	57
CPB012	57
CPB013	57
CPB014	57
CPB015	57
CPC001	57
CPC002	57
CPC003	57
CPC004	57
CPC005	57
CPC006	57

CPC007	57
CPC008	57
CPC009	57
CPC010	57
CPC011	57
CPC012	57
CPC013	57
CPC014	57
CPC015	57
CPC016	57
CPC017	57
CPD001	58
CPD002	58
CPD003	58
CPD004	58
CPD005	58
CPD006	58
CPD007	58
CPD008	58
CPD009	58
CPD010	58
CPD011	58
CPD012	58
CPF001	59
CPF002	59
CPF003	59
CPF004	59
CPF005	59
CPF006	59
CPF007	59
CPF008	59
CPF009	59
CPF010	59
CPF011	59
CPF012	58
CPK001	59
CPK002	59
CPK003	59
CPK004	59
CPK005	59
CPK006	59
CPK007	59
CPK008	59
CPK009	59
CPK010	59
CPK011	59
CPK012	59
CPK013	59
CPK014	59
CPK015	59
CPL001	60
CPL002	60
CPL003	60
CPL004	60
CPL005	60
CPL006	60
CPL007	60
CPL008	60
CPN001	60
CPN002	60
CPN003	60
CPN004	60
CPN005	60

D
volumetry

DBB001	62
DBB002	62
DBB003	62
DBB004	62
DBB005	62
DBB006	62
DBB007	62
DBB008	62
DBB009	62
DBB018	62
DBB019	62
DBB020	62
DBB021	62
DBB022	62
DBB023	62
DBB024	62
DBB025	62
DBB026	62
DBB027	62
DB	

DBB032	62	DGB001	65	DLB010	68	FCM006	75	FFN003	81	FMB017	88
DBB033	62	DGB002	65	DLB011	68	FCM007	75	FFN005	81	FMB018	88
DBB034	62	DGB003	65	DLB012	68	FCM008	75	FFN006	81	FMB019	88
DBB035	62	DGB004	65	DLD001	68	FCM009	75	FHD001	81	FMB020	88
DBB036	63	DGB005	65	DNB007	69	FCM010	75	FHD002	81	FMB021	88
DBB037	63	DGB006	65	DNB008	69	FCM011	75	FHD003	81	FMB022	88
DBB038	63	DGB007	65	DNB009	69	FCM019	75	FHD004	81	FMB023	88
DBB039	63	DGB008	65	DNB010	69	FCM020	75	FHD005	81	FMB024	88
DBB040	63	DGB009	65	DNB011	69	FCM021	75	FHD006	81	FMD001	88
DBB041	63	DGB010	65	DNB012	69	FCM022	75	FHD007	81	FMD002	88
DBB042	63	DGB011	65	DNB015	69	FCP001	76	FHD008	81	FMD003	89
DBB043	63	DGB012	65	DNB016	69	FCP002	76	FHD009	81	FMD004	89
DBB044	63	DGB013	65	DND002	70	FCP003	76	FHD010	81	FMD005	89
DBB045	62	DGB014	65	DND003	70	FCP004	76	FHD011	81	FMD006	89
DBB046	62	DGB015	65	DND004	70	FCP005	76	FHN001	81	FMD007	89
DBB047	62	DGB016	65	DND005	69	FCP006	76	FHN002	81	FMD008	89
DBB048	62	DGB017	65	DND006	69	FCP007	76	FHN003	81	FMG001	89
DBB049	62	DGB018	65	DND007	69	FCP008	76	FHN004	81	FMG002	89
DBB050	62	DGB019	65	DNM001	70	FCP009	76	FKB005	82	FMG003	89
DBB051	62	DGB020	65	DNM002	70	FCP010	76	FKB006	82	FMJ001	90
DBB052	62	DGD001	66	DNM003	70	FCP011	76	FKB007	82	FMJ002	90
DBB053	62	DGD002	66	DNM004	70	FCP012	76	FKB008	82	FMJ003	90
DBG001	63	DGD003	66	DNM005	70	FCP013	76	FKB009	82	FMJ004	90
DBG002	63	DGD005	66	DNM006	70	FCP014	77	FKB010	82	FMJ005	90
DBG003	63	DGG001	66	DNM007	70	FCP015	77	FKB011	82	FMJ006	90
DBG004	63	DGG002	66	DNM008	70	FCP016	77	FKB012	82	FMJ007	90
DBG005	63	DGG003	66	DNM009	70	FCP017	77	FKB015	82	FMJ008	90
DBG006	63	DGG004	66	DNM010	70	FCP018	77	FKB016	82	FMJ009	90
DBG007	63	DGG005	66	DNM011	70	FCP019	77	FKB017	82	FMJ010	90
DBG008	63	DGG006	66	DNM012	70	FCP020	77	FKB018	82	FMJ011	90
DBG009	63	DGG007	66	DNM013	70	FCR001	77	FKB019	82	FMJ012	90
DBG010	63	DGG008	66	DNM014	70	FCR002	77	FKB020	83	FMJ013	90
DBG011	63	DGG009	66			FCR003	77	FKB021	83	FMJ014	90
DBG012	63	DGG010	66			FCR004	77	FKB022	83	FML002	90
DBG013	63	DGG011	66			FCR009	77	FKB023	83	FML003	90
DBG014	63	DGG012	66			FCR010	77	FKB024	83	FML004	90
DBG015	63	DGJ001	66			FCR011	77	FKB025	83	FML005	91
DBG016	63	DGJ002	66			FCR012	77	FKB026	83	FML006	91
DBG017	63	DGJ003	66			FCV001	78	FKB027	83	FML007	91
DBG018	63	DGJ004	66			FCV002	78	FKB028	83	FML008	91
DBJ001	63	DGJ005	66			FCV003	78	FKB029	83	FML009	91
DBJ002	63	DGJ006	66			FCV004	78	FKB030	84	FML010	91
DBJ003	63	DGJ007	66			FCV005	78	FKB031	84	FML011	92
DBJ004	63	DGJ008	66			FCV006	78	FKB032	84	FML012	92
DBJ005	63	DGJ009	66			FCV008	78	FKB033	84	FML013	92
DBJ006	63	DGJ010	66			FCY002	78	FKB034	84	FML014	92
DBJ007	63	DJB001	66			FCY003	78	FKB035	84	FML015	91
DBJ008	63	DJB002	66			FCY004	78	FKD001	84	FML016	91
DDB001	64	DJB003	66			FCY005	78	FKD002	84	FML017	91
DDB002	64	DJB004	66			FCY006	78	FKG001	84	FMN001	92
DDB003	64	DJB005	66			FCY007	78	FKG002	84	FMN004	92
DDB004	64	DJB006	66			FCY008	78	FKG005	84	FMN005	92
DDB005	64	DJB007	66			FCY009	78	FKG006	84	FMN006	92
DDB006	64	DJB008	66			FCY010	78	FKG007	84	FMN007	92
DDB007	64	DJB009	66			FCY011	78	FKG009	84	FMN009	92
DDB008	64	DJD001	67			FCY012	78	FKL001	85	FMN010	92
DDB009	64	DJD002	67			FCY013	78	FKL002	85	FMN011	92
DDB010	64	DJD003	67			FCY014	78	FKL003	85	FMN012	92
DDB011	64	DJD004	67			FCY015	78	FKL004	85	FMN013	92
DDB012	64	DJD005	67			FCY016	78	FKL005	85	FMN014	92
DDB013	64	DJD006	67			FCY018	78	FKL006	85	FMN015	92
DDB014	64	DJG001	67			FCY019	78	FKN001	85	FMN016	92
DDB015	64	DJG002	67			FFB001	78	FKN002	85	FMN018	92
DDB016	64	DJG003	67			FFB002	78	FKN003	85	FMN019	92
DDB017	64	DJG004	67			FFB003	78	FKN004	85	FMN020	92
DDB018	64	DJG005	67			FFB004	78	FKN005	85	FMN021	93
DDB019	64	DJG006	67			FFB005	78	FKN007	85	FMN022	93
DDB020	64	DJG007	67			FFB006	79	FKN008	85	FMN023	93
DDB021	64	DJG008	67			FFB007	79	FKP001	85	FMN024	93
DDB022	64	DJG009	67			FFB008	79	FKP002	86	FMN025	93
DDB023	64	DJJ001	67			FFD001	79	FKP003	86	FMN026	93
DDB024	64	DJJ002	67			FFD002	79	FKP004	86	FMN028	93
DDB025	64	DJJ003	67			FFD003	79	FKP005	86	FMN029	93
DDB026	64	DJJ004	67			FFG001	79	FKP006	86	FMN030	93
DDB027	64	DJJ005	67			FFG002	79	FKR001	86	FMQ001	94
DDB028	64	DJJ006	67			FFG003	79	FKR002	86	FMQ002	94
DDB029	64	DJJ007	67			FFG004	79	FKW001	86	FMQ003	94
DDB030	64	DJP001	67			FFJ002	79	FKW002	86	FMQ004	94
DDB031	64	DJP002	67			FFJ003	80	FKW003	86	FMQ005	94
DDB032	64	DJP003	67			FFJ004	80	FKW004	86	FMQ006	94
DDB033	64	DJP004	67			FFJ005	80	FMB001	87	FMQ007	94
DDB034	64	DJP005	67			FFJ006	80	FMB002	87	FZB001	95
DDB035	64	DJP006	67			FFJ007	79	FMB003	87	FZB002	95
DDB036	65	DJP007	67			FFL001	80	FMB004	87	FZB003	95
DDB037	65	DJP008	67			FFL002	80	FMB005	87	FZB004	95
DDB038	65	DJP009	67			FFL003	80	FMB006	87	FZD002	95
DDB039	65	DJR001	68			FFL004	80	FMB007	87	FZD003	95
DDB040	65	DJR002	68			FFL005	80	FMB008	87	FZG001	95
DDB041	65	DJR003	68			FFL006	80	FMB009	87	FZG002	95
DDB042	65	DJR004	68			FFL007	80	FMB010	87	FZG003	95
DDB043	65	DJR005	68			FFL009	80	FMB011	87	FZG004	95
DDB044	65	DJR006	68			FFL010	80	FMB012	88		
DDB045	65	DJR007	68			FFL011	80	FMB013	88		
DDB046	65	DJR008	68			FFL012	80	FMB014	88		
DDW001	65	DLB001	68			FFN001	81	FMB015	88		
DDW002	65	DLB002	68			FFN002	81	FMB016	88		

F
laboratory
assemblies and
tools

FCB001	72
FCB002	72
FCB003	72
FCB007	72
FCB008	72
FCB009	72
FCB010	72
FCB011	72
FCB012	72
FCB013	72
FCB015	72
FCB016	72
FCB017	72
FCB018	72
FCB019	72
FCB020	72
FCB021	72
FCB022	72
FCB023	72
FCB024	72
FCB025	72
FCB026	72
FCB027	72
FCB028	72
FCB029	72
FCB030	72
FCB031	72
FCB032	72
FCB033	72
FCB034	72
FCB035	72
FCB036	72
FCB037	72
FCB038	72
FCB039	72
FCB040	72
FCB041	72
FCB042	72
FCB043	72
FCB044	72
FCB045	72
FCB046	72
FCB047	72
FCB048	72
FCB049	72
FCB050	72
FCB051	72
FCB052	72
FCB053	72
FCB054	72
FCB055	72
FCB056	72
FCB057	72
FCB058	72
FCB059	72
FCB060	72
FCB061	72
FCB062	72
FCB063	72
FCB064	72
FCB065	72
FCB066	72
FCB067	72
FCB068	72
FCB069	72
FCB070	72
FCB071	72
FCB072	72
FCB073	72
FCB074	72
FCB075	72
FCB076	72
FCB077	72
FCB078	72
FCB079	72
FCB080	72
FCB081	72
FCB082	72
FCB083	72
FCB084	72
FCB085	72
FCB086	72
FCB087	72
FCB088	72
FCB089	72
FCB090	72
FCB091	72
FCB092	72
FCB093	72
FCB094	72
FCB095	72
FCB096	72
FCB097	72
FCB098	72
FCB099	72
FCB100	72
FCB101	72
FCB102	72
FCB103	72
FCB104	72
FCB105	72
FCB106	72
FCB107	72
FCB108	72
FCB109	72
FCB110	72
FCB111	72
FCB112	72
FCB113	72
FCB114	72
FCB115	72
FCB116	72
FCB117	72
FCB118	72
FCB119	72
FCB120	72
FCB121	72
FCB122	72
FCB123	72
FCB124	72
FCB125	72
FCB126	72
FCB127	7

G

centrifuges

GBC001	99
GBC002	99
GBC003	99
GBF001	99
GBF003	100
GBF006	100
GBF007	100
GBF008	100
GBF010	101
GBK001	101
GBK002	101
GBK003	101
GBK004	101
GBK005	101
GBK006	101
GBK007	101
GBK008	102
GBK009	102
GBK010	102
GBK011	102
GBK012	102
GDC001	102
GDC002	102
GDC003	102
GDC004	102
GDC005	103
GDF001	103
GDF002	103
GGC001	103
GGC002	103
GGF001	104
GGF002	104
GJC002	104
GJC006	104
GJK001	104
GJK002	104
GJK003	104
GJK004	104
GJK005	104
GLC001	104
GLF001	105
GLH001	105
GLH002	105
GLH003	105
GLH004	105
GLH005	105
GLH006	105
GLH007	105
GNC001	107
GNP001	107
GNP002	107
GNP003	107
GNP004	107
GNP005	107
GNP006	107
GNP007	107
GNP008	108
GNP009	108
GNP010	108

H

optical equipments

HBB003	110
HBB010	110
HBB011	110
HBC002	111
HBC006	112
HBC007	112
HBC008	112
HBC009	112
HBC010	112
HBC011	112
HBC013	113
HBC014	113
HBC015	111
HBC016	111
HBD001	113
HBD002	113
HBD003	114

HBF001	114
HBG001	115
HBG002	115
HBH004	116
HBH005	116
HBH006	117
HBJ001	117
HBJ002	117
HBK001	118
HBK002	118
HBK003	118
HBK004	119
HBK005	119
HBL001	120
HBL002	120
HBL003	120
HBL004	120
HBL005	120
HBM001	120
HBM002	120
HBN001	120
HBN003	120
HBP001	121
HBP002	121
HBP003	121
HBP004	121
HBP005	121
HBP006	121
HBP007	121
HBP008	121
HBP009	121
HBP010	121
HBP011	121
HBP012	121
HBP013	121
HBP014	121
HBP015	121
HBP016	121
HBP017	121
HBP018	121
HBP019	121
HBP020	121
HBP021	121
HBP022	121
HBP023	121
HBP024	121
HBP025	121
HBP026	121
HBP027	121
HBQ001	121
HBQ002	121
HBQ003	121
HBQ004	121
HBQ005	121
HBQ006	121
HBQ007	121
HBQ008	121
HBQ009	121
HBQ010	121
HBR002	122
HBR003	122
HBR004	122
HBR005	122
HBR006	121
HBR007	121
HBR008	122
HBR009	122
HBR010	121
HBR011	122
HBR012	122
HBR013	122
HBR014	121
HBR015	122
HBR016	122
HBR017	122
HBR018	121
HBR019	121
HBR020	122
HBR021	122
HBR022	122
HBR023	122
HBR024	122
HDB002	122
HDB004	122
HDD006	123
HDD007	124
HDD008	124
HDD009	124
HDD010	124
HDD011	123
HDD012	123
HDG001	125
HDG002	125
HDG003	125
HDG004	125
HDG005	125

HDG006	125
HDG007	125
HDG008	125
HDG009	125
HDG010	125
HDG011	125
HDG012	125
HDG013	125
HDG014	125
HDG015	125
HDH001	125
HDH002	125
HDH003	125
HDH004	125
HDH005	125
HDH006	125
HDH007	125
HDH008	125
HDH009	125
HDH010	125
HDH011	125
HDJ001	125
HDJ002	125
HDJ003	125
HDJ004	125
HDJ005	125
HDJ006	125
HDK001	126
HDK002	126
HDK003	126
HDK004	126
HDK005	126
HDK006	126
HDK007	126
HDK008	126
HDK009	126
HDK012	126
HDK013	126
HDK014	126
HDK015	126
HDK017	126
HDK019	126
HGB002	126
HGB003	126
HGB004	126
HGB005	126
HJB001	127
HJB002	127
HJB003	127
HJB004	128
HJB005	128
HJB006	128
HJD001	128
HJD002	129
HJD003	129
HJD004	130
HJD005	130
HJD006	130
HJD007	131
HJG001	131
HJG002	132
HJG003	132
HJG004	132
HJG005	132
HJG006	132
HJG007	132
HJH001	132
HJH002	132
HJH003	132
HJH004	132
HJH005	132
HJH006	132
HJH007	132
HJH008	133
HJH009	133
HJH010	132
HJH017	132
HJH018	132
HJH019	132
HJH020	133
HJH021	132
HJH022	132
HJH023	132
HJH024	132
HJK001	133
HJK002	133
HJK003	133
HJK004	133
HJK005	133
HJK006	133
HJK007	133
HJK008	133
HJK009	133
HJK010	133
HJK011	133
HJK012	134

HJK013	134
HJK014	134
HJK015	134
HJK016	134
HJK017	134
HJL001	135
HJL002	135
HJL003	135
HJL004	135
HJL005	135
HJL006	135
HJL007	135
HJL008	135
HJL009	135
HJL010	135
HJL011	135
HJL012	136
HJL013	136
HJL014	136
HJL015	136
HJM001	136
HJM001	137
HMB002	137
HMB003	137
HMB004	137
HMB005	138
HMF001	138
HMF002	138
HMF003	138
HMF004	138
HMF005	138
HMF006	138
HMG001	138
HMG002	138
HMG003	138
HMG004	138
HMG005	138
HMG006	138
HPB001	139
HPB002	139
HPD001	140
HPD002	140
HPD003	140
HPD004	140
HPD005	141
HPD006	141
HPD008	141
HPD009	142
HPD010	142
HPD011	142
HPD012	140
HPD013	140
HPD014	140
HPD015	140
HPD016	141
HPD017	141
HPD019	141
HPD020	142
HPD021	142
HPF001	142
HPF002	142
HPF004	142
HPF005	142
HPF007	142
HPH001	143
HPH002	143
HPH003	143
HPH004	143
HPH005	143
HPH007	144
HPK001	144
HPK002	144
HPK005	144
HPK006	145
HPM001	145
HPM002	145
HPM003	145
HPP001	145
HPP002	146
HPP003	146
HPP004	146
HPP005	146
HPP006	146
HPP007	146
HPP008	146
HPP009	146
HRB008	148
HRB010	148
HRB011	148
HRD001	148
HRD002	148
HRG003	148
HRG004	148

J

heating cooling

JBB001	150
JBB002	150
JBB003	150
JBB004	150
JBB005	150
JBD001	150
JBD002	150
JBD003	150
JBD004	150
JBD005	150
JBD006	150
JBD007	150
JBD008	150
JBD009	150
JBG001	151
JBG002	151
JBG003	151
JBG004	151
JBG005	151
JBG006	151
JBG007	151
JDB001	151
JDD001	151
JDD002	151
JDD003	151
JDD004	151
JDD005	152
JDD006	152
JDG001	152
JDS001	152
JDS002	153
JDS003	153
JDS004	153
JDS005	153
JDS006	154
JDV001	154
JDV002	154
JDV003	154
JDV004	154
JDV005	154
JDV006	154
JDV007	154
JDV008	154
JDV009	154
JDV010	154
JDV011	154
JDV012	154
JDV013	154
JDV014	154
JDV015	154
JDV016	154
JGB001	155
JGB002	155
JGB003	155
JGB004	155
JGB005	155
JGB006	155
JGB007	155
JGB008	155
JGD001	155
JGD002	155
JGD003	155
JGD004	155
JGD005	155
JGD006	155
JGD007	155
JGD008	155

K

measuring instruments

KBB001	159
KBB002	159
KBB003	159
KBB004	158
KBB005	158
KBB006	158
KBB007	158
KBB008	159

KBB009	159
KBB010	159
KBB011	159
KBC001	159
KBC002	159
KBC003	159
KBC004	159
KBC005	160
KBC006	160
KBC007	160
KBC008	160
KBC009	160
KBD001	160
KBD002	160
KBD003	160
KBD004	161
KBD005	161
KBF001	161
KBF002	161
KBF003	161
KBF004	161
KBH001	162
KBH002	162
KBH003	162
KBN001	162
KBN002	162
KBN003	162
KBN004	162
KBN005	162
KBN006	162
KBN007	162
KBN008	162
KBN009	162
KBN010	162
KBN011	162
KBN012	162
KBN013	162
KBN014	162
KBN015	162
KBN016	162
KBN017	162
KBN018	162
KBN019	162
KBN020	162
KBN021	162
KBN022	162
KBN048	163
KBP003	163
KBP004	163
KBP005	163
KBP006	163
KBP007	163
KBP008	163
KBQ003	163
KBQ004	163
KBQ005	163
KBQ006	164
KBQ007	164
KBR001	164
KBR002	164
KBR003	165
KBR004	165
KBS001	165
KBS002	165
KBS003	165
KBS004	165
KBS005	165
KBS006	165
KBS007	165
KBS008	165
KBS009	165
KBS010	165
KBS011	165
KBS012	165
KBS013	165
KBS014	165
KBS015	165
KBT001	166
KBT002	166
KBT003	166
KBT004	166
KBT005	166
KBT	

KBV004	166	KJP004	175	LBG004	188	LJJ006	198	MGB024	208	PBH010	218
KBV005	166	KJP005	175	LBG005	188	LJJ007	198	MGB025	208	PBH011	218
KBV006	166	KJR002	175	LBG010	189	LJJ008	198	MGD001	209	PBH012	218
KBV007	166	KJR003	176	LBG011	187	LJJ009	198	MGD002	209	PBH013	218
KBV008	166	KJR006	176	LBJ001	189	LJJ010	198	MGD003	209	PBH014	218
KBV009	166	KKB001	176	LBM002	189	LJL001	198	MGD004	209	PBH015	218
KBV010	166	KKB005	176	LBM003	189	LJL002	198	MGD005	209	PBH016	218
KBV011	166	KKF001	177	LBM004	189	LJN001	199	MGD006	209	PBH017	218
KBV012	166	KKF002	177	LBM005	189	LJN002	199	MGD007	209	PBH018	218
KBV013	166	KLBO01	177	LBM006	189	LJN003	199	MGD008	209	PBH019	218
KBV014	166	KLBO02	177	LBM007	189	LJN004	199	MGG001	210	PBH030	218
KBV015	166	KLBO03	177	LBM008	190	LJQ001	200	MGG002	210	PBJ001	218
KBV016	166	KLBO04	177	LBM009	190	LJQ002	200	MGG003	210	PBJ002	218
KBW001	167	KLBO05	177	LBM010	190	LJQ003	200	MGG004	210	PBJ003	218
KBW002	167	KLBO06	177	LBM011	190	LJS001	201	MGG005	210	PBJ004	218
KBW003	167	KLBO07	177	LBM012	190	LJS002	201	MGG006	210	PBJ005	218
KBW004	167	KLBO08	177	LBM013	190	LJS003	201	MGG007	210	PBJ006	218
KBW005	167	KLBO09	177	LBM014	190	LJS004	201	MGG008	210	PBK001	219
KBW006	167	KLBO10	177	LBM015	190	LJS005	201	MGG009	210	PBK002	219
KBW007	167	KLBO11	177	LBM016	190	LJS006	201	MGG010	210	PBK003	219
KBW008	167	KLBO12	177	LBM017	190	LJS007	201	MGJ001	210	PBK004	219
KBW009	167	KLBO13	177	LBM018	190	LJS008	201	MGM039	210	PBK005	219
KBW010	167	KLBO14	177	LDB001	191	LJS009	201	MGM040	210	PBK006	219
KBW011	167	KLD001	177	LDB002	191	LJS010	201	MGM041	210	PBK007	219
KBW012	167	KLD002	177	LDB003	191	LJS011	201	MGM042	210	PBK008	219
KBW013	167	KLD003	177	LDB004	191	LJS012	201	MGT001	211	PBK009	219
KBW014	167	KLD004	177	LDB005	191	LJS013	201	MJB011	211	PBK010	219
KBW015	167	KLD005	177	LDB006	191	LLB001	202	MJJ016	211	PBK011	219
KBW016	167	KLD006	177	LDB007	191	LLB002	202	MJN015	211	PBK012	219
KBW017	167	KLD007	177	LDB008	191	LLB003	202	MJQ009	211	PBK013	219
KBW018	167	KLD008	177	LDB009	191	LLB004	202	MJV017	212	PBL001	219
KBW019	167	KLD009	177	LDB010	191	LLB005	202	MJV018	212	PBL002	219
KDB001	167	KLD010	177	LDB011	191	LLB006	202	MJV019	212	PBL003	219
KDB002	167	KLD011	177	LDB012	191	LLF001	203	MJV020	212	PBL004	219
KDD001	168	KLGO01	178	LDB013	191	LLF002	203	MJV021	212	PBL005	219
KDD002	168	KLGO02	178	LDB014	191	LLF003	203			PBL006	219
KDD004	168	KLGO03	178	LDD001	191	LLF004	203			PBL007	219
KDD005	169	KLGO04	178	LDD002	191	LLF005	203			PBL008	219
KDD006	168	KLGO05	178	LDD003	191	LLF006	203			PBL009	219
KDG001	169	KLGO06	178	LDD004	191	LLF007	203			PBL010	219
KDG002	169	KLGO07	178	LDD005	191	LLF008	203			PBL011	219
KDG003	169	KLGO08	178	LDD006	191	LLF009	203			PBL012	219
KDG005	169	KLGO09	178	LDD007	191					PBL013	219
KDG011	170	KLGO10	178	LDD008	191					PBL014	219
KDJ001	170	KLGO11	178	LDD009	191					PBL015	219
KDJ002	170	KLGO12	178	LDG001	191					PBL016	219
KDJ003	170	KLGO14	178	LDG002	191					PBL017	219
KDJ004	170	KLGO15	178	LDG003	191					PBL018	219
KDJ005	170	KLGO20	178	LDG004	191					PBL019	219
KDJ006	170	KLJ001	178	LDG005	191					PBL020	219
KDJ007	170	KLJ002	178	LDG006	191					PBL021	219
KDJ009	170	KLJ003	178	LDG007	191					PBL022	219
KDJ016	170	KLJ004	178	LDP011	192					PBC001	220
KDJ019	170	KLJ005	178	LDP012	192					PBC002	220
KDJ020	170	KLJ006	178	LDR001	192					PBC003	220
KGB003	170	KLJ007	178	LDR002	192	MBB001	206	PBD001	217	PBD001	217
KGB004	170	KLL001	179	LDR003	192	MBB002	206	PBD002	217	PBD002	217
KGB005	170	KLL002	179	LDR004	192	MBB003	206	PBD003	217	PBD003	217
KGB007	170	KLL003	179	LDR005	192	MBB004	206	PBD004	217	PBD004	217
KGB008	171	KLL005	179	LGB001	192	MBD002	206	PBD005	217	PBD005	217
KGB010	171	KLNO03	179	LGB002	193	MBG008	206	PBD006	217	PBD006	217
KGD001	171	KLNO06	179	LGB003	194	MBJ007	207	PBD007	217	PBD007	217
KGD002	172	KLQ004	179	LGD001	194	MBJ008	207	PBD008	217	PBD008	217
KGD003	172	KNB001	179	LGG001	193	MBJ009	207	PBD009	217	PBD009	217
KGG003	173	KNB002	180	LGG002	193	MBL013	207	PBD010	217	PBD010	217
KJB003	173	KNB003	180	LGG003	193	MBL014	207	PBD011	217	PBD011	217
KJB004	173	KNB004	180	LGG004	193	MBL015	207	PBD012	217	PBD012	217
KJB010	173	KZB001	181	LGG005	193	MBL016	207	PBD013	217	PBD013	217
KJB011	173	KZB002	181	LGG006	193	MBL017	207	PBD014	217	PBD014	217
KJB012	173	KZD001	182	LGG007	193	MBL018	207	PBD015	217	PBD015	217
KJB013	173	KZD002	182	LGG008	193	MBL019	207	PBD016	217	PBD016	217
KJB014	173	KZD003	182	LGG009	194	MBL020	207	PBD017	217	PBD017	217
KJB016	173	KZD004	182	LGG010	195	MDD001	208	PBD018	217	PBD018	217
KJB017	173			LGG011	195	MDD002	208	PBD019	217	PBD019	217
KJB018	173			LGG012	195	MDD003	208	PBD020	217	PBD020	217
KJB019	173			LGG013	195	MDD004	208	PBD021	217	PBD021	217
KJB020	173			LGG014	195	MDJ052	208	PBF001	217	PBF001	217
KJB021	173			LGG015	195	MDJ053	208	PBF002	217	PBF002	217
KJB022	173			LGG016	195	MDJ054	208	PBF003	217	PBF003	217
KJD001	173			LGG018	195	MDJ055	208	PBF004	217	PBF004	217
KJD002	173			LGG019	194	MDJ056	208	PBF005	217	PBF005	217
KJD005	173			LGG020	194	MDJ057	208	PBF006	217	PBF006	217
KJD006	173			LGG021	194	MDJ058	208	PBF007	217	PBF007	217
KJD007	173			LJB002	195	MGB001	209	PBG001	217	PBG001	217
KJD008	173			LJB003	196	MGB002	209	PBG002	217	PBG002	217
KJD009	173			LJD001	196	MGB003	209	PBG003	217	PBG003	217
KJJ001	174	LBB001	185	LJD002	196	MGB004	209	PBG004	217	PBG004	217
KJJ002	174	LBB002	185	LJG001	197	MGB005	209	PBH001	218	PBH001	218
KJM001	174	LBB003	185	LJG002	197	MGB006	209	PBH002	218	PBH002	218
KJM002	174	LBB004	185	LJG003	197	MGB007	209	PBH003	218	PBH003	218
KJM003	174	LBD001	186	LJG004	197	MGB008	209	PBH004	218	PBH004	218
KJM006	174	LBD002	186	LJJ001	197	MGB009	209	PBH005	218	PBH005	218
KJM014	175	LBD003	186	LJJ002	197	MGB019	208	PBH006	218	PBH006	218
KJM015	174	LBD004	187	LJJ003	197	MGB020	208	PBH007	218	PBH007	218
KJP001	175	LBD005	187	LJJ004	197	MGB021	208	PBH008	218	PBH008	218
KJP002	175	LBG002	188	LJJ005	197	MGB022	208	PBH009	218	PBH009	218
		LBG003	188			MGB023	208				

P
filtration and separation

PBB001	214	PBL010	219
PBB002	214	PBL011	219
PBB003	214	PBL012	219
PBB004	215	PBL013	219
PBB005	215	PBL014	219
PBC001	216	PBL015	219
PBC002	216	PBL016	219
PBC003	216	PBL017	219
PBD001	217	PBL018	219
PBD002	217	PBL019	219
PBD003	217	PBL020	219
PBD004	217	PBL021	219
PBD005	217	PBL022	219
PBD006	217	PBL028	220
PBD007	217	PBL029	220
PBD008	217	PBL030	220
PBD009	217	PBM001	220
PBD010	217	PBM002	220
PBD011	217	PBM003	220
PBD012	217	PBM004	220
PBD013	217	PBM005	220
PBD014	217	PBM006	220
PBD015	217	PBM007	220
PBD016	217	PBM008	220
PBD017	217	PBM009	220
PBD018	217	PBM010	220
PBD019	217	PBM011	220
PBD020	217	PBM012	220
PBD021	217	PBM013	220
PBF001	217	PBM014	221
PBF002	217	PBM015	221
PBF003	217	PBM016	221
PBF004	217	PBM017	221
PBF005	217	PBM018	221
PBF006	217	PBM019	221
PBF007	217	PBM020	221
PBG001	217	PBM021	221
PBG002	217	PBM022	221
PBG003	217	PBM023	221
PBG004	217	PBM024	221
PBH001	218	PBM025	221
PBH002	218	PBM026	221
PBH003	218	PBM027	221
PBH004	218	PBM028	221
PBH005	218	PBM029	222
PBH006	218	PBP001	222
PBH007	218	PBP002	222
PBH008	218	PBQ021	222
PBH009	218	PBQ022	222
		PBQ026	222
		PBQ027	222
		PBQ028	222
		PBQ029	223
		PBQ030	223
		PBQ031	

PBQ033	223	PLG011	232	PSB007	236	PSD042	238	PSF079	239	PSG085	241
PBQ034	222	PLG012	232	PSB008	236	PSD043	238	PSF080	239	PSG086	241
PBQ035	222	PLG013	232	PSB009	236	PSD044	238	PSF081	239	PSG087	241
PBR001	224	PLG014	232	PSB010	236	PSD045	238	PSF082	239	PSG088	241
PBR002	224	PLG015	232	PSB011	236	PSD046	238	PSF083	239	PSG089	241
PBR004	224	PNB001	233	PSB012	236	PSD047	238	PSF084	239	PSG090	241
PBV001	224	PNB002	233	PSB013	236	PSD048	238	PSF085	239	PSG091	241
PBV002	224	PNB003	233	PSB014	236	PSD049	238	PSF086	239	PSG093	242
PBV003	224	PNB004	233	PSB015	236	PSD050	238	PSF087	239	PSG094	242
PBV004	224	PNB005	233	PSB016	236	PSD051	238	PSF088	239	PSG095	242
PBZ001	225	PNB006	233	PSB017	236	PSD052	238	PSF089	239	PSG096	242
PBZ002	225	PNB007	233	PSB018	236	PSD053	238	PSF090	239	PSG097	242
PBZ003	225	PNC001	233	PSB019	236	PSD054	238	PSF091	239	PSG098	242
PDB001	225	PNC002	233	PSB020	236	PSD055	238	PSF092	239	PSG099	242
PDD001	226	PNC003	233	PSB021	236	PSD056	238	PSF093	239	PSG100	242
PDD002	226	PNC004	233	PSB022	236	PSD057	238	PSG001	240	PSG101	242
PDD003	226	PNF001	233	PSB023	236	PSD058	238	PSG002	240	PSG102	242
PDD004	226	PNF002	233	PSB024	236	PSD059	238	PSG003	240	PSG103	242
PDG001	226	PNF003	233	PSC001	237	PSF001	238	PSG004	240	PSG104	242
PDG002	226	PNF004	233	PSC002	237	PSF002	238	PSG005	240	PSG105	242
PDG003	227	PNF005	233	PSC003	237	PSF003	238	PSG006	240	PSG106	242
PDJ001	227	PNF006	233	PSC004	237	PSF004	238	PSG007	240	PSG107	242
PDJ002	227	PNF007	233	PSC005	237	PSF005	238	PSG008	240	PSG108	242
PDJ003	227	PNF008	234	PSC006	237	PSF006	238	PSG009	240	PSG109	242
PDJ004	227	PNF009	234	PSC007	237	PSF007	238	PSG010	240	PSG110	242
PDJ005	227	PNF010	234	PSC008	237	PSF008	238	PSG011	240	PSG111	242
PDJ006	227	PNF011	234	PSC009	237	PSF009	238	PSG012	240	PSG112	242
PDJ007	227	PNF012	234	PSC010	237	PSF010	238	PSG013	240	PSG113	242
PDJ008	227	PNF013	234	PSC011	237	PSF011	238	PSG014	240	PSG114	242
PDJ009	227	PNF014	234	PSC012	237	PSF012	238	PSG015	240	PSG115	242
PDJ010	227	PNF015	234	PSC013	237	PSF013	238	PSG016	240	PSG116	242
PDJ011	227	PNF016	234	PSC014	237	PSF014	238	PSG017	240	PSG117	242
PDJ012	227	PNF017	234	PSC015	237	PSF015	238	PSG019	240	PSG118	242
PGB001	227	PNF018	234	PSC016	237	PSF016	238	PSG020	240	PSG119	242
PGB002	227	PNG004	234	PSC017	237	PSF017	238	PSG021	240	PSG120	242
PGB006	228	PNG005	234	PSC018	237	PSF018	238	PSG022	240	PSG121	242
PGB007	228	PNG006	234	PSC019	237	PSF019	238	PSG023	240	PSG122	242
PGG001	228	PNG007	234	PSC020	237	PSF020	238	PSG024	240	PSG123	242
PGG002	228	PNG008	234	PSC021	237	PSF021	238	PSG025	240	PSG127	241
PGG003	228	PNG009	234	PSC022	237	PSF022	238	PSG026	240	PSG128	241
PGG004	228	PNG010	234	PSC023	237	PSF023	238	PSG027	240	PSG129	241
PGG006	228	PNG011	234	PSC024	237	PSF024	238	PSG028	240	PSG130	241
PGG007	228	PNG012	234	PSC025	237	PSF025	238	PSG029	240	PSG131	241
PGG008	228	PNG013	234	PSC026	237	PSF026	238	PSG030	240	PSG132	241
PGG014	229	PNG014	234	PSC027	237	PSF027	238	PSG031	240	PSG133	241
PGG015	229	PNG015	234	PSC028	237	PSF028	238	PSG034	240	PSG134	241
PGG016	229	PNG016	234	PSC029	237	PSF029	238	PSG035	240	PSG135	241
PGG017	229	PNG017	234	PSC030	237	PSF030	238	PSG036	240	PSG136	241
PGG018	229	PNG018	234	PSC031	237	PSF031	239	PSG037	240	PSG137	241
PGG019	229	PNG019	234	PSC032	237	PSF032	239	PSG038	240	PSG138	241
PGG020	229	PNG020	234	PSC033	237	PSF033	239	PSG039	240	PSG139	241
PGG021	229	PNG021	234	PSC034	237	PSF034	239	PSG040	240	PSG140	241
PGG022	229	PNG022	234	PSC035	237	PSF035	239	PSG041	240	PSG141	241
PGG024	229	PNG023	234	PSC036	237	PSF036	239	PSG042	240	PSG142	241
PGG025	229	PNG024	234	PSC037	237	PSF037	239	PSG043	240	PSG143	241
PGG026	229	PNG025	234	PSD001	237	PSF038	239	PSG044	240	PSG144	241
PGG027	229	PNG026	234	PSD002	237	PSF039	239	PSG045	240	PSG145	241
PGG028	229	PNG027	234	PSD003	237	PSF040	239	PSG046	240	PSG146	241
PJB001	229	PNG028	234	PSD004	237	PSF041	239	PSG047	240	PSG147	241
PJB002	230	PNM010	235	PSD005	237	PSF042	239	PSG048	240	PSG148	241
PJB003	230	PNM011	235	PSD006	237	PSF043	239	PSG049	240	PSG149	241
PJB004	230	PNM012	235	PSD007	237	PSF044	239	PSG050	240	PSG150	241
PJB005	230	PNM013	235	PSD008	237	PSF045	239	PSG051	240	PSG151	241
PJD001	231	PNM014	235	PSD009	237	PSF046	239	PSG052	240	PSG152	241
PJD002	231	PNM015	235	PSD010	237	PSF047	239	PSG053	240	PSG153	241
PJD003	231	PNM016	235	PSD011	237	PSF048	239	PSG054	240	PSG154	241
PJD006	231	PNM017	235	PSD012	237	PSF049	239	PSG055	240	PSG155	241
PJD008	231	PNM018	235	PSD013	237	PSF050	239	PSG056	240	PSG156	241
PJD009	231	PNZ001	235	PSD014	237	PSF051	239	PSG057	241	PSH001	242
PJD010	231	PNZ002	235	PSD015	237	PSF052	239	PSG058	241	PSH002	242
PJD011	231	PQB001	235	PSD016	237	PSF053	239	PSG059	241	PSH003	242
PJD012	231	PQB002	235	PSD017	237	PSF054	239	PSG060	240	PSH004	242
PJD013	231	PQB003	235	PSD018	237	PSF055	239	PSG061	240	PSH005	242
PJD014	231	PQB004	235	PSD019	237	PSF056	239	PSG062	240	PSH006	242
PJD015	231	PQB005	235	PSD020	237	PSF057	239	PSG063	240	PSH007	242
PJH001	231	PQB006	235	PSD021	237	PSF058	239	PSG064	240	PSH008	242
PJH002	231	PQB007	235	PSD022	237	PSF059	239	PSG065	241	PSH009	242
PJH003	231	PQB008	235	PSD023	237	PSF060	239	PSG066	241	PSH010	242
PJH004	231	PQB009	235	PSD024	237	PSF061	239	PSG067	241	PSH011	242
PLB001	232	PQB010	235	PSD025	237	PSF062	239	PSG068	241	PSH012	242
PLB002	232	PQD001	235	PSD026	237	PSF063	239	PSG069	241	PSH013	242
PLB003	232	PQD002	235	PSD027	237	PSF064	239	PSG070	241	PSH014	242
PLB004	232	PQD003	235	PSD028	237	PSF065	239	PSG071	241	PSH015	242
PLB005	232	PQD004	235	PSD029	237	PSF066	239	PSG072	241	PSH016	242
PLB006	232	PQD005	235	PSD030	238	PSF067	238	PSG073	241	PSH017	242
PLB007	232	PQD006	235	PSD031	238	PSF068	239	PSG074	241	PSH018	242
PLG001	232	PQD007	235	PSD032	238	PSF069	239	PSG075	241	PSH019	242
PLG002	232	PQD008	235	PSD033	238	PSF070	239	PSG076	241	PSH020	242
PLG003	232	PQL001	236	PSD034	238	PSF071	239	PSG077	241	PSH021	242
PLG004	232	PQL002	236	PSD035	238	PSF072	239	PSG078	241	PSH022	242
PLG005	232	PSB001	236	PSD036	238	PSF073	239	PSG079	241	PSH023	242
PLG006	232	PSB002	236	PSD037	238	PSF074	239	PSG080	241	PSH024	242
PLG007	232	PSB003	236	PSD038	238	PSF075	239	PSG081	241	PSH025	242
PLG008	232	PSB004	236	PSD039	238	PSF076	239	PSG082	241	PSH026	242
PLG009	232	PSB005	236	PSD040	238	PSF077	239	PSG083	241	PSH027	242
PLG010	232	PSB006	236	PSD041	238	PSF078	239	PSG084	241	PSH028	242

PSH029	242	PSN007	245	PSZ004	249	QBB013	256	QGB052	268	QGF069	269
PSH030	242	PSN008	245	PSZ005	249	QBB014	256	QGB053	268	QGF070	269
PSH031	242	PSN009	245	PSZ006	249	QBB015	257	QGB054	268	QGF071	269
PSK001	243	PSN010	245	PSZ007	249	QBB017	258	QGB055	268	QGF072	269
PSK002	243	PSN011	245	PSZ008	249	QBB018	258	QGB056	268	QGF073	269
PSK003	243	PSN012	245	PSZ009	249	QBB019	258	QGB057	268	QGF074	269
PSK004	243	PSN013	245	PSZ010	249	QBB020	260	QGB058	267	QGF075	269
PSK005	243	PSN014	245	PSZ011	249	QBB021	260	QGB059	267	QGF076	269
PSK006	243	PSN015	245	PSZ012	249	QBB022	259	QGB060	268	QGF077	269
PSK007	243	PSN016	245	PSZ013	249	QBB023	262	QGB061	267	QGF078	269
PSK008	243	PSN017	245	PSZ014	249	QBB024	257	QGB062	267	QGF079	270
PSK009	243	PSN018	245	PSZ015	249	QBB025	257	QGB063	267	QGF080	269
PSK010	243	PSN019	245	PSZ016	249	QBB026	257	QGB064	267	QGF081	270
PSK011	243	PSN020	245	PSZ017	249	QBB027	257	QGB065	268	QGF082	270
PSK012	243	PSN021	245	PSZ018	249	QBB028	257	QGB066	267	QGF083	270
PSK013	243	PSN022	245	PSZ019	249	QBB029	254	QGB067	268	QGF084	270
PSK014	243	PSP043	245	PVB001	250	QBB030	258	QGB068	268	QGF085	270
PSK015	243	PSP044	245	PVB002	250	QBB031	261	QGB069	268	QGF086	269
PSK016	243	PSP045	245	PVB003	250	QBB032	261	QGB070	267	QGF087	270
PSK017	243	PSP046	245	PVB004	250	QBB033	261	QGB071	267	QGF088	270
PSK018	243	PSP047	245	PVB005	250	QBB034	261	QGB072	268	QGF089	270
PSK019	243	PSP048	245	PVB006	250	QBB035	261	QGB073	267	QGF090	270
PSK020	243	PSP049	245	PVB007	250	QBB036	259	QGB074	267	QGF091	269
PSK021	243	PSP050	245	PVB008	250	QBB037	259	QGB075	267	QGF092	270
PSK022	243	PSP051	245	PVB009	250	QBB038	260	QGB076	267	QGF093	270
PSL001	243	PSP052	245	PVB010	250	QBB039	262	QGB077	267	QGF094	270
PSL002	243	PSP053	245	PVB011	250	QBB040	260	QGB078	267	QGF095	270
PSL003	243	PSP054	245	PVB012	250	QBB041	256	QGB079	267	QGF096	270
PSL004	243	PSP055	245	PVB013	250	QBG001	263	QGF001	270	QGF097	270
PSL005	243	PSP056	245	PVB014	250	QBG002	263	QGF002	270	QGF098	270
PSL006	243	PSP057	245	PVB015	250	QBG003	263	QGF003	270	QGF099	270
PSL007	243	PSP058	245	PVB016	250	QBG004	262	QGF004	268	QGF100	270
PSL008	243	PSP059	245	PVB017	250	QBG006	263	QGF005	268	QGF101	270
PSL009	243	PSP060	245	PVB018	250	QBG007	264	QGF006	268	QGF102	270
PSL010	243	PSP061	245	PVB019	250	QBN001	264	QGF007	268	QGF103	270
PSL011	243	PSP062	245	PVB020	250	QBN002	264	QGF008	268	QGF104	270
PSL012	243	PSP063	245	PVB021	250	QBN003	264	QGF009	268	QGF105	269
PSL013	243	PSR001	246	PVB022	250	QBN004	265	QGF010	268	QGF106	269
PSL014	243	PSR002	246	PVB023	250	QBN005	265	QGF011	268	QGF107	270
PSL015	243	PSR003	246	PVB024	250	QBN006	265	QGF012	268	QGF108	270
PSL016	243	PSR004	246	PVB025	250	QBN007	265	QGF013	268	QGF109	271
PSL017	243	PSR005	246	PVB026	250	QBQ001	265	QGF014	269	QGF110	270
PSL018	243	PSR006	246	PVB027	250	QBQ003	266	QGF015	269	QGF111	270
PSL019	243	PSR007	246	PVB028	250	QBQ004	266	QGF016	269	QGF112	270
PSL020	243	PSR008	246	PVB029	250	QBQ005	266	QGF017	269	QGF113	269
PSL021	243	PSR009	246	PVB030	250	QBQ001	267	QGF018	269	QGF114	270
PSL022	243	PSR010	246	PVB031	250	QBQ002	267	QGF019	269	QGF115	270
PSL023	244	PSR011	246	PVB032	250	QBQ003	267	QGF020	269	QGF116	268
PSL024	244	PSR012	246	PVB033	250	QBQ004	268	QGF021	269	QGF117	269
PSL025	244	PSR013	246	PVB034	250	QBQ005	267	QGF022	269	QGF118	269
PSL026	244	PSR014	246	PVZ001	251	QBQ006	268	QGF023	268	QGF119	270
PSL027	244	PSR015	246	PVZ002	251	QBQ007	268	QGF024	269	QGF120	270
PSL028	244	PSR016	246	PVZ003	251	QBQ008	268	QGF025	269	QGF121	270
PSL029	244	PSR017	246	PVZ004	251	QBQ009	268	QGF026	269	QGF122	269
PSL030	244	PSR018	246	PVZ005	251	QBQ010	268	QGF027	269	QGF123	270
PSL031	244	PSR019	246	PVZ006	251	QGB011	267	QGF028	269	QGF124	271
PSL032	244	PSR020	246	PVZ007	251	QGB012	267	QGF029	269	QGF125	268
PSL033	244	PSR021	246	PVZ008	251	QGB013	267	QGF030	269	QGF126	269
PSL035	244	PSR022	246	PVZ009	251	QGB014	267	QGF031	269	QGF127	269
PSL036	244	PSR023	246	PVZ010	251	QGB015	267	QGF032	269	QGF128	269
PSL037	244	PSR024	246	PVZ011	251	QGB016	267	QGF033	271	QGF129	268
PSL038	244	PSR025	246	PVZ012	251	QGB017	267	QGF034	271	QGF130	268
PSL039	244	PSR026	247	PVZ013	251	QGB018	267	QGF035	271	QGF131	271
PSL040	244	PSR027	247	PVZ014	251	QGB019	267	QGF036	271	QGF132	269
PSL041	244	PSR028	247	PVZ015	251	QGB020	267	QGF037	271	QGF133	270
PSL042	244	PSR029	247	PVZ016	251	QGB021	267	QGF038	271	QGJ001	271
PSL043	244	PSR030	247	PXB001	252	QGB022	267	QGF039	271	QGJ002	271
PSL044	244	PSR031	247	PXB002	252	QGB023	267	QGF040	271	QGJ003	271
PSM001	244	PSR032	247	PXL001	252	QGB024	268	QGF041	271	QGJ004	271
PSM002	244	PSR033	247	PZB003	252	QGB025	268	QGF042	271	QGJ005	271
PSM003	244	PSR034	247	PZB004	252	QGB026	268	QGF043	271	QGJ006	272
PSM004	244	PSR035	247	PZB005	252	QGB027	268	QGF044	271	QGJ007	272
PSM005	244	PSR036	247	PZB006	252	QGB028	268	QGF045	271	QGJ008	272
PSM006	244	PSR037	247	PZB007	252	QGB029	268	QGF046	269	QGJ009	271
PSM007	244	PSR038	247	PZB008	252	QGB030	268	QGF047	271	QGJ010	272
PSM008	244	PSR039	247			QGB031	268	QGF048	271	QGJ011	272
PSM009	244	PSR040	247			QGB032	268	QGF049	271	QGJ012	272
PSM010	244	PSR041	247			QGB033	267	QGF050	271	QGJ013	271
PSM011	244	PSR042	247			QGB034	267	QGF051	269	QGJ014	271
PSM012	244	PSR043	247			QGB035	267	QGF052	270	QGJ015	271
PSM013	244	PSR044	247			QGB036	267	QGF053	270	QGJ016	271
PSM014	244	PSR045	247			QGB037	267	QGF054	270	QGJ017	271
PSM015	244	PSR046	248			QGB038	268	QGF055	270	QGJ018	272
PSM016	244	PSR047	248			QGB039	267	QGF056	270	QGJ019	272
PSM017	244	PSR048	248			QGB040	267	QGF057	270	QGJ020	272
PSM018	244	PSR049	248			QGB041	268	QGF058	270	QGJ021	272
PSM019	244	PSX001	248			QGB042	267	QGF059	270	QGJ022	272
PSM020	244	PSX002	248			QGB043	267	QGF060	270	QGJ023	272
PSM021	244	PSX003	248			QGB044	267	QGF061	270	QGJ024	272
PSM022	244	PSX004	248			QGB045	267	QGF062	270	QGJ026	272
PSN001	245	PSX005	248			QBB006	255	QGF063	270	QGJ027	272
PSN002	245	PSX006	248			QBB007	255	QGF064	270	QGJ028	272
PSN003	245	PSX007	248			QBB008	259	QGF065	269	QGJ029	272
PSN004	245	PSZ001	248			QBB010	255	QGF066	269	QGJ030	272
PSN005	245	PSZ002	249			QBB011	255	QGF067	269	QGJ031	272
PSN006	245	PSZ003	249			QBB012	255	QGF068	269	QGJ032	272

Q

didactic material

Glasses	293
Gloves	296
Graduated pipettes	65
Class A with bulb, glass	65
Class A without bulb, glass	66
Class B with bulb, glass	66
Class B without bulb, glass	66

H

Hartl disk	281
Hausser Gedigk staining jar	28
Heating mantles	155
Mantles with stirring	155
Mantles without stirring	155
Hellendahl staining jar	27
High capacity centrifuges	107
Bench top	107
Accessories, adapters	107
Histology bath for paraffin sections	306
Hot plate for histology	306
Hydrometers	177
Alcoholometers	177
Aerometers	177
Hydrometers	178
Saccharometers	178
Mustimeters	179
Liquid hydrometers	179
Pycnometers	179

I

Incineration capsules	59
Incineration cuvettes	60
Inclined plane	277
Inoculating loops	29
ISO bottles	42
Clear glass	42
Amber glass	43
Iron filling, fine	284

J

Jars	39
Plastic, moulded grad	39
Porcelain	39
Joule's calorimeter	282

L

Laboratory jacks	72
Laplace's rail	285
Lid for cassettes	27

M

Magdeburgo hemispheres	278
Magnetic field demonstrators	285
Magnetic stirrers	185
With heating, analogical	185
With heating, digital	186
Without heating, analogical	187
Without heating, digital	189
Accessories	189
Magnets and rods	191
Cylindrical magnets	191
Oval magnets	191
Octagonal magnets	191
Other magnets	192
Stirring rods	192
Magnifying glasses	148
Hand	148
Talbè	148
Thread counters	148
Manifolds	229
Manual controllers	206
Masks	296
Measuring cylinders	62
Class A, tall form, glass	62
Class B, tall form, glass	63
Class B, tall form, plastic	6
Melde's apparatus	279
Membrane pumps	252
Microhaematocrit capillaries	313
Microhematocrit centrifuges	103
Bench top	103
Accessories	104
Microtomes	304
Micropipettes	208
Adjustable volume	208
Fixed volume	209

Multichannel	210
Repeater pipettes	210
Electronic pipettes	210
Stands	210
Microscopes	110
Education	110
Professional	111
Digital	113
Fluorescence	114
Polarization	115
Metallurgical	116
Inverted biological	117
Operation	118
Accessories, condensers	120
Accessories, phase contrast	120
Accessories, polarization	120
Accessories, objectives	121
Accessories, eyepieces	121
Accessories, others	121
Milk analyzer, Lactoscan SP	309
Minicentrifuges	102
Minicentrifuges	102
Accessories	103
Models	256
Anatomy	256
Botanics	264
Zoology	266
Astronomy	267
Molecular kits	268
Mortars	6
With pestle, glazed, porcelain	6
With pestle, not glazed, porcelain	6
With pestle, glass	6
With pestle, agate	6
Pestles, standard shape, porcelain	7
Pestles, glass	7
Pestles, agate	7
Jars f/mills, agate	7
Balls	8
Multidimensional shakers	195
Oscillating	195
Roll and tilt	196
Rotative	197
Rotative, accessories	197
3 D	198
Orbital	199
Linear	200
Orbital and linear, accessories	201
Multiparametric analyzer	182
Newton colour disks	280

O

Optical bench	280
Ovens	150
Incubators	150
Drying ovens	150
Incubators, accessories	151
Overhead stirrers	202
Stirring heads	202
Accessories	203

P

Paddle blenders	308
Paraffin dispensing unit	306
Pasteur pipettes	68
pH-meters	167
Testers	167
Laboratory pH-meters	168
Electrodes and accessories	169
pH paper	170
Physics	279
Mechanics and fluids	279
waves and sound	280
Lights and optics	282
Thermology	284
Magnetism and electrostatics	286
Electricity and electronics	288
Prepared slides	269
Animal histology	269
Plant histology	270
Zoology	273
Minerals	275
Slide sets	275
Petri dish	29
Pipette pumps	207
Polarimeters	137
Polarimeters	137
Polarimeters, calibration pieces	138
Accessories	138
Power supply for electrophoresis	304
Power supply for spectral tubes	281
Protection paper	296

R

Racks and supports	14
For tubes, plastic	14
For tubes, metal	16
For tubes, PVC	17
For microtubes	18
For pipettes	19
For flasks	19
For funnels	20
Inverted biological	281
Refractometers	139
Abbe	139
Hand, Brix scale	139
Hand, salinity	142
Hand, oenology	143
Hand, batteries	144
Hand, clinical	145
Hand, others	145
Rings, open	77
Rings, closed	78
Rods without thread	78
Rotary evaporators	227
Rubber fillers/teats	207

S

Scissors	92
Shcieferdecker staining jar	28
Spectral tubes	282
Spot plates	29
Staining jar	28
Stands	72
Stoppers f/glass bottles	49
Stoppers f/plastic bottles	50
Scalpels/blades	165
Separating funnels	235
Squibb	235
Gilson	235
Cylindrical	236
Shoe covers	297
Showers and eyewashes	297
Single-rotor centrifuges	99
Bench top, analogical	99
Bench top, digital	99
Accessories	101
Slide storage	25
Slides	22
Soxhlet extractors	216
Soxhlet extractors, thimbles	217
Spatule/spoons	82
Spoon-spatula	82
Spoon-spatula, micro	84
Spatula	84
Double spatula	85
Double spatula, micro	85
Spoons	85
Double spoons	86
Scoops	86
Spectrophotometers	127
Visible	127
UV/Visible	128
Checking standars	131
Accessories	132
Cells, glass	133
Cells, quartz	135

Spring balances	163
Stabilizing rings	95
Stations	297
Stereomicroscopes	122
Education	122
With zoom	123
Accessories, objectives	125
Accessories, eyepieces	125
Accessories, supports	125
Accessories, others	125
Stoppers	20
Glass	20
Conical shape, rubber	21
Perforated, rubber	21
Borers	21
Stopwatches	176
Syringe filters	250

T

Tanks	51
With dispenser, plastic	51
Without dispenser, plastics	53
Table protectors	298
Thermal conductivity apparatus	282
Thermalcycler	301

Thermometers	173
Solid stem	173
Enclosed scale	173
With metal probe	174
Room temperature	174
For refrigerators	175
Others	176
Timers	177
Tips and other consumables	210
10 µl	210
200 µl	210
1000 µl	210
2/5/10 ml	210
Tongs f/beakers, tubes	81
Tongs f/crucibles, capsules	80
Transilluminator	304
Triangles	79
Tripod stands	78
Tubes	10
Test tube	10
Centrifuge tubes	11
Culture tubes	11
U Tubes	12
Tube caps	12
Microtubes	13
Others	13
Tubing f/laboratory	81
Tuning forks with box	279

U

Universal centrifuges	105
Bench top	105
Bench top, refrigerated	106
Accessories, rotors	106
Untrasound baths	298
Urine containers	313
U-tube manometer	278

V

Van de Graaf generator	285
Vials	53
Injection	53
For pills	53
Closures for vials	54
Vibrator generator with accessories	279
Vibrating mixers	192
For tubes	192
For microplates	194
Accessories	194
Videocameras	126
Videocameras C-mount	126
Volumetric flasks	64
Class A, with stopper, glass	64
2 marks, glass	65
Volumetric pipettes	66
1 mark, class A, with bulb	66
1 mark, class A, without bulb	67
1 mark, class B, with bulb	67
1 mark, class B, without bulb	67
2 marks, class A, with bulb	67
2 marks, class B, without bulb	68

W

Water jet pumps	252
Wash bottles	51
Narrow mouth	51
Stoppers	51
Wave form helix	278
Weights E2	165
Weights F1	166
Weights F2	166
Weights M1	167
Wimshurst electrostatic generator	286
Wine pipettes	68
Wiping paper	300



The group:

AUXILAB S.L.
Material de laboratorio
Laboratory supplies



Pol. Morea Norte Calle D
31191 Beriain, Navarra
T. 948 31 05 13
F. 948 31 20 71
Email: correo@auxilab.es
www.auxilab.es

23 Rue Ampère, ZI de Villemilan
91325 Wissous (France)
T.: +33 1 69 53 67 67
F.: +33 1 69 30 72 55
Email: rogosampaic@rogosampaic.com
www.rogosampaic.com

Distributed by:

